



TM



# PARTS



# CATALOG

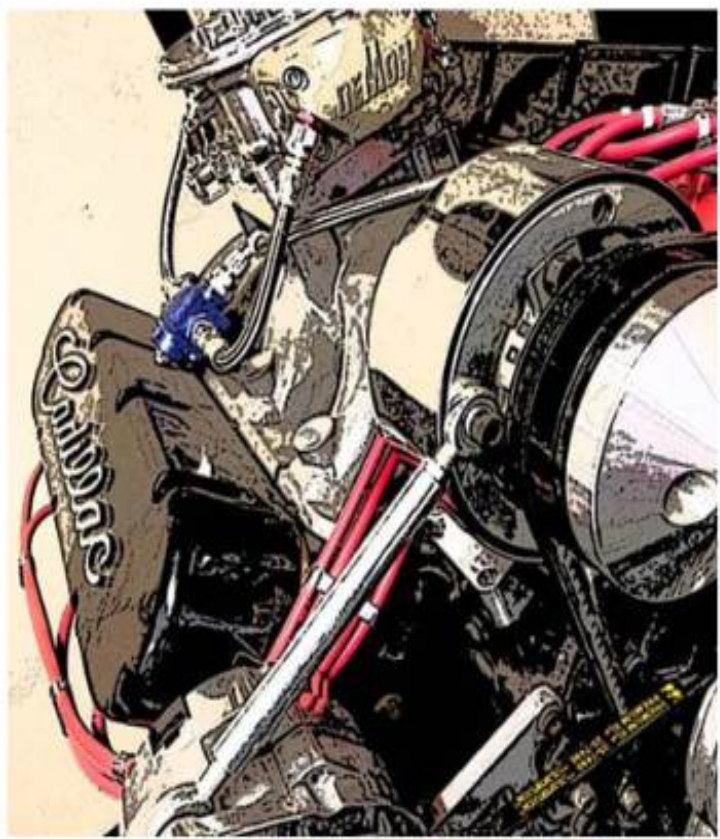



# TABLE OF CONTENTS

<b>Overhaul, Rotating, and Bottom End Parts</b> .....	2
Hardware .....	22
Rings and Bearings .....	30
Rotating Parts .....	35
Crankshafts, Stroker Kits, Crank Hubs, and Vibration Dampeners .....	44
Main Studs, Girdles, and Scrapers .....	48
Rods and Pistons .....	50

# OVERHAUL ROTATING AND BOTTOM END PARTS



## VT13174 TRUE ROLLER TIMING CHAIN SET

SKU: VT13174

[Read More](#)

Price: \$190.00



## RB77102 CAM BEARINGS, CC3 GROOVED / DUAL HOLE STYLE

SKU: RB77102

Cam Bearings, CC3 grooved / dual hole style

[Read More](#)

Price: \$116.60





## RB77101 CAM BEARINGS, STOCK REPLACEMENT

**SKU:** RB77101

Cam bearings, stock replacement style

[Read More](#)

**Price:** \$52.28



## RB75110 CLEVITE 'H' SERIES ROD BEARINGS

**SKU:** RB75110

Clevite™ 'H' series rod bearings. Set of 8 pairs.

Recommended for competition use only.

[Read More](#)

**Price:** \$220.00



## RB75100 ROD BEARINGS FOR 472 / 500 / 425 / 368

**SKU:** RB75100

Rod Bearings - set of 8 pairs for 472 / 500 / 425 / 368.

[Read More](#)

**Price:** \$187.20



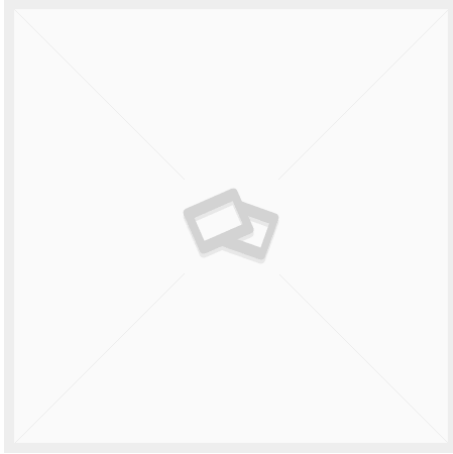

## RB73101 ROD AND MAIN BEARING KIT FOR 472 / 500 / 425 / 368

**SKU:** RB73101

Rod and main bearing kit for 472 / 500 / 425 / 368.

Includes: Main Bearings, set of 5 pairs, Rod bearings set of 8 pairs.

[Read More](#)

**Price:** ~~\$402.93~~ \$362.64



## RB71100 MAIN BEARINGS FOR 472 / 500 / 425 / 368

**SKU:** RB71100

Main Bearings, set of 5 pairs, for 472 / 500 / 425 / 368.

[Read More](#)

**Price:** \$215.73



## RB59170 PISTON RING SET FOR 425

**SKU:** RB59170

Piston rings for 425 engines.

Standard width (5/64" / 5/64" / 3/16").

Complete set (1 set per engine).

We recommend Moly rings for most builds.

[Read More](#)

**Price:** \$105.17 - \$219.43

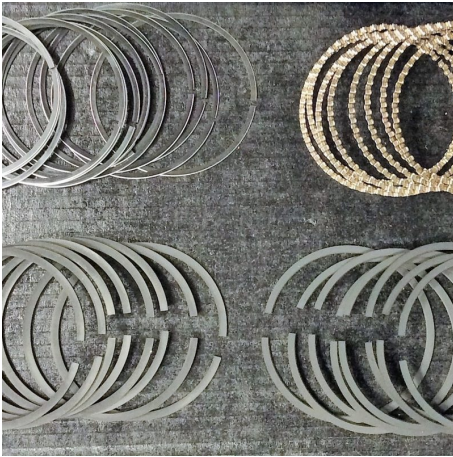

## RB59115 SKINNY (1/16") MOLY PISTON RING SET FOR 472 / 500 FOR CAD COMPANY FORGED PISTONS

**SKU:** RB59115

'Skinny' Piston rings for 472 / 500 engines with Cad Company forged pistons. Narrow width (1/16" / 1/16" / 3/16") - These rings ONLY fit forged pistons intended for skinny rings. Not applicable to stock replacement or KB pistons, or most forged pistons aside from the current Cad Company off-the-shelf forged pistons or something custom-made-to-order for these rings.

Complete set (1 set per engine).

Only available in Moly, and only available in the sizes listed.

[Read More](#)

**Price:** \$219.43

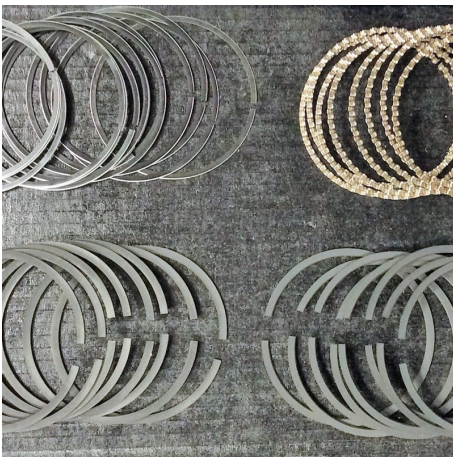

## RB59110 PISTON RING SET FOR 472 / 500

**SKU:** RB59110

Piston rings for 472 / 500 engines. Standard width (5/64" / 5/64" / 3/16") - for any off-the-shelf piston that does not specify narrow rings.

Complete set (1 set per engine).

We recommend Moly rings for most builds.

[Read More](#)

**Price:** \$120.00 - \$197.20



## RB55472 10:1 FORGED PISTONS - 472 CID W/ 76CC HEADS - D-DISH

**SKU:** RB55472

Cad Company forged pistons - D-Dish - 10:1 compression for 472 CID Cadillac engines with 76cc heads. With coated skirts. Price includes pins. Valve reliefs clear iron and aluminum heads. Uses 1/16" ring pack for reduced friction. Made in USA

[Read More](#)

**Price:** \$750.00



## RB55176 9:1 FORGED PISTONS - 500 CID - FLAT TOP

**SKU:** RB55176

Cad Company forged pistons - Flat Top - 9:1 compression for 500 CID Cadillac engines with 120cc heads (or 13:1 w/ 76cc heads). With coated skirts. Price includes pins. No valve reliefs. Uses 1/16" ring pack for reduced friction. Made in USA

[Read More](#)

**Price:** \$750.00

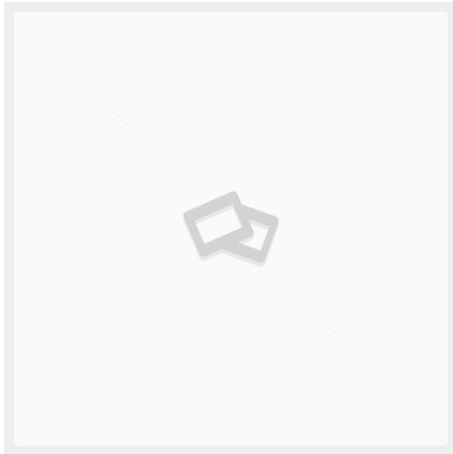

## RB55174 10:1 FORGED PISTONS - 500 CID W/ 120CC HEADS - DOMED

**SKU:** RB55174

Cad Company forged pistons - D-Dish - 10:1 compression for 500 CID Cadillac engines with 120cc heads, or 14:1 compression for 500 CID Cadillac engines with 76cc OE or ported OE heads. With coated skirts. Price includes pins. Valve reliefs clear iron and aluminum heads. Uses 1/16" ring pack for reduced friction. Made in USA

[Read More](#)

**Price:** \$750.00



## RB55172 10:1 FORGED PISTONS - 500 CID W/ 76CC HEADS - D-DISH

**SKU:** RB55172

Cad Company forged pistons - D-Dish - 10:1 compression for 500 CID Cadillac engines with 76cc heads. With coated skirts. Price includes pins. Valve reliefs clear iron and aluminum heads. Uses 1/16" ring pack for reduced friction. Made in USA

[Read More](#)

**Price:** \$750.00



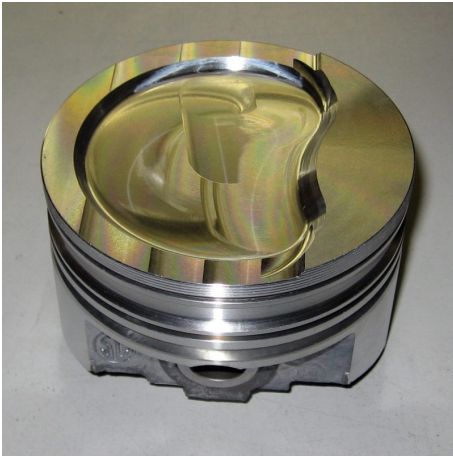

## RB53116 KEITH BLACK PISTONS 9.8:1 FOR 472 W/76CC HEADS 1968-1973

**SKU:** RB53116

Keith Black Hypereutectic Piston 9.8:1 (76cc heads) 472CID .030,.040 & .060 fits 1968-1973

[Read More](#)

**Price:** ~~\$781.12~~ \$660.09

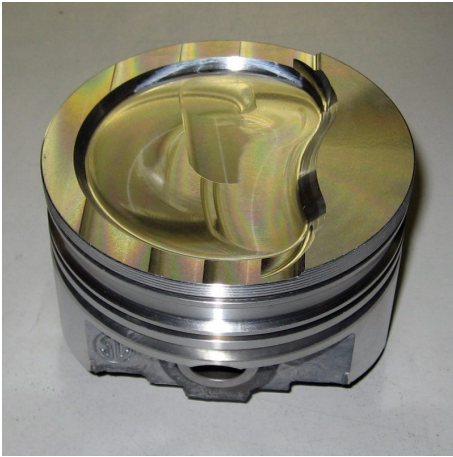

## RB53114 KEITH BLACK 10:1 PISTONS FOR 500CID

**SKU:** RB53114

[Read More](#)

**Price:** \$695.00

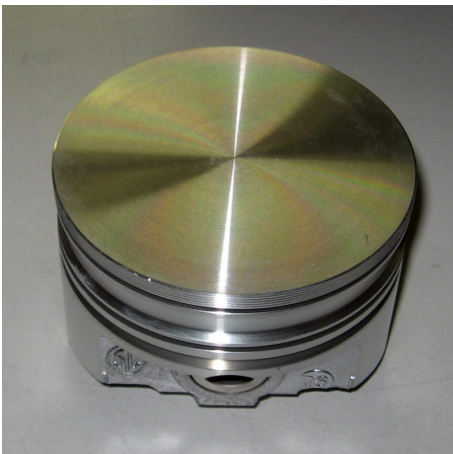

## RB53111 KEITH BLACK FLAT TOP PISTONS 1974-1976

**SKU:** rb53111

[Read More](#)

**Price:** ~~\$738.88~~ \$624.31



## RB51131 472 PISTONS 10:1 COMP RATIO W/76CC HEADS

**SKU:** RB51131

[Read More](#)

**Price:** \$575.00



## RB51120 CAST REPLACEMENT PISTONS WITH PINS FOR CADILLAC 472 AND 500 ENGINES

**SKU:** RB51120

**Cast replacement pistons** for Cadillac 472 and 500 Engines, with pins  
Available in standard (STD), .020", .030", .040", and .060" over bore sizes.

[Read More](#)

**Price:** \$550.00



## RB51110 SILVOLITE CAST REPLACEMENT PISTONS WITH PINS FOR CADILLAC 472, 500, AND 425 ENGINES

**SKU:** RB51110

**Silvolite cast replacement pistons** for Cadillac 472, 500, and 425  
Engines, with pins.  
Available in standard (STD), .020", .030", .040", and .060" over bore sizes.

[Read More](#)

**Price:** \$595.00

## RB40111 CRANK KEY

**SKU:** RB40111

**Crankshaft key** for timing gear / crank hub for Cadillac 472 / 500 / 425 / 368 engines. The correct factory style key. Nothing special, just the right thing.

[Read More](#)

**Price:** \$6.00



## RB35112 HD FORGED H BEAM RODS

**SKU:** RB35112

Set of 8 new heavy-duty forged I-beam rods, w/ 7/16" cap screws and bushed for floating pins.

Recommended for N/A or boosted engines over 700 HP.

[Read More](#)

**Price:** \$695.00





## RB33113 HD FORGED I BEAM RODS

**SKU:** RB33113

Set of 8 new heavy-duty forged I-beam rods, w/ 7/16" cap screws and bushed for floating pins.

Recommended for engines over 700 HP.

[Read More](#)

**Price:** \$595.00



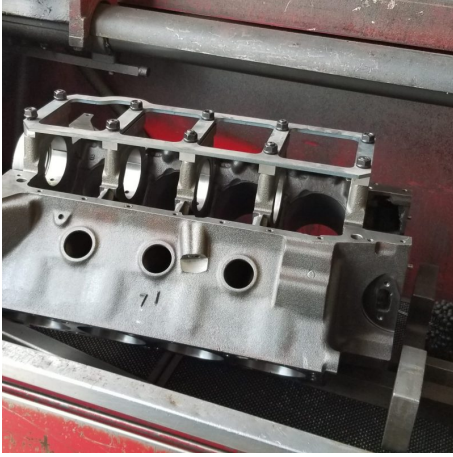

## RB19123 MAIN GIRDLE KIT WITH CAP SUPPORTS

**SKU:** RB19123

**Halo main girdle kit with cap supports**

[Read More](#)

**Price:** \$499.00

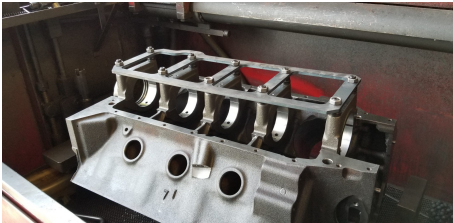

## RB19121 HALO MAIN GIRDLE KIT

**SKU:** RB19121

**Halo main girdle kit**

[Read More](#)

**Price:** \$350.00



## PB12306 HARMONIC DAMPER W/ HUB, SFI CERTIFIED

**SKU:** PB12306

**SFI Certified One-Piece Harmonic Vibration Damper**

[Read More](#)

**Price:** \$390.00

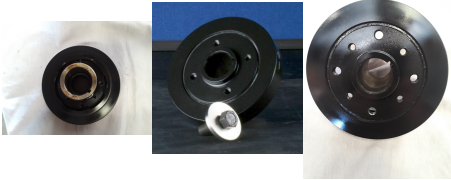

## PB11202 BILLET STEEL CRANK HUB (OFFSET)

**SKU:** PB11202

Offset Billet Steel Crank Hub

This hub has offset flange spacing for correct pulley alignment using non-dampener pulleys with aftermarket performance dampeners that go between the pulley and hub, with the standard 4-bolt pulley pattern. This hub fits all 472 / 500 / 425 / 368 engines, and maintains the correct press-fit.

[Read More](#)

**Price:** \$190.00

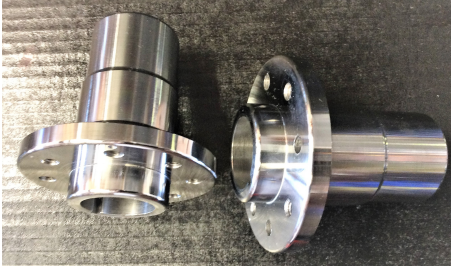

## PB11201 BILLET STEEL CRANK HUB

**SKU:** PB11201

Standard Replacement Billet Steel Crank Hub

This hub is a direct replacement for the stock crank hub, in tougher billet steel form. Suitable for any application for which the factory hub will fit, but you need a replacement (due to a lost or damaged factory hub), or something tougher. This hub fits all 472 / 500 / 425 / 368 engines, and maintains the correct press-fit.

[Read More](#)

**Price:** \$250.00







## PB11122 CRANK HUB BOLT AND WASHER KIT

**SKU:** PB11122

**Crank Hub Bolt and Washer Kit** Correct washer to clear the pulley. Fits the front of the crankshaft, to positively retain the crank hub or damper (or dampener or balancer, as some folks call them).

[Read More](#)

**Price:** \$15.00



## PB11113 CRANK HUB SLEEVE

**SKU:** PB11113

Crank hub sealing surface repair sleeve.

[Read More](#)

**Price:** \$95.00

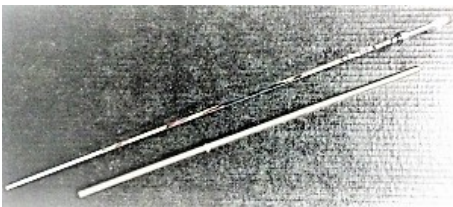

## OS40220 DIPSTICK TUBE POLISHED STAINLESS STEEL W/ CHROME DIPSTICK

**SKU:** OS40220

Dipstick Tube Polished stainless steel with chrome dipstick

[Read More](#)

**Price:** \$75.00

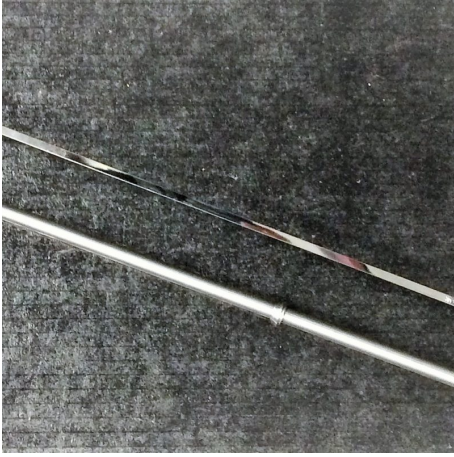

## OS40210 DIPSTICK TUBE STAINLESS STEEL W/ CHROME DIPSTICK

**SKU:** OS40210

Dipstick Tube Stainless steel with chrome dipstick

[Read More](#)

**Price:** \$49.00

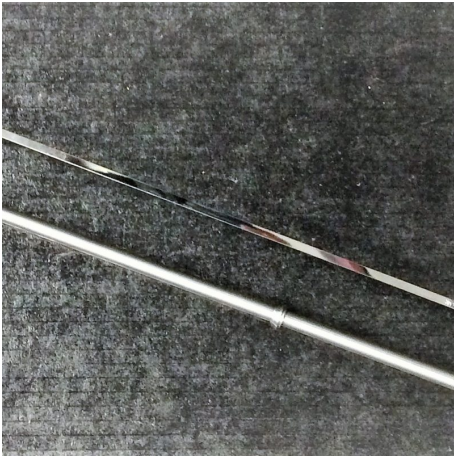

## OS40110 DIPSTICK TUBE CHROME W/ CHROME DIPSTICK

**SKU:** OS40110

Dipstick Tube chrome with chrome dipstick

[Read More](#)

**Price:** \$45.00



## OS40010 DIPSTICK TUBE UNIVERSAL, OE

**SKU:** OS40010

Universal, OE

[Read More](#)

**Price:** \$100.00



## OS10151 CRANK SCRAPER

**SKU:** OS10151

[Read More](#)

**Price:** \$55.00



## OL21101 ASSEMBLY LUBE: CLEVITE™ BEARING GUARD

**SKU:** OL21101

8 oz. Assembly Lube: Clevite™ Bearing Guard

[Read More](#)

**Price:** \$13.50

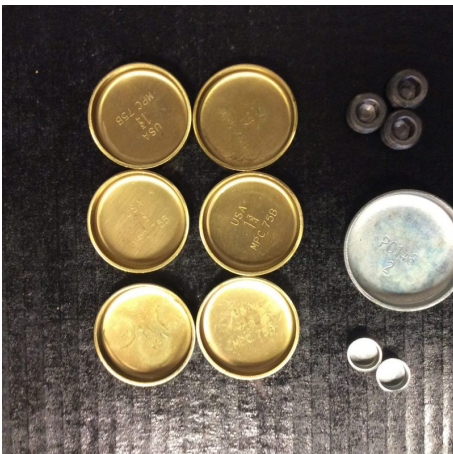

## BH15301 FREEZE PLUG KIT (STANDARD) BRASS

**SKU:** BH15301

Brass

[Read More](#)

**Price:** \$26.00





## **BH15001 FREEZE PLUG KIT (STANDARD) STEEL**

**SKU:** BH15001

Steel

[Read More](#)

**Price:** \$15.00



## **BH13143 OIL GALLEY THREADED PLUG**

**SKU:** BH13143

3/8" Pipe Thread Plugs

3-4 per engine - rear of main oil galleys, oil pressure access port above oil pump, and coolant port just below thermostat housing.

[Read More](#)

**Price:** \$0.40

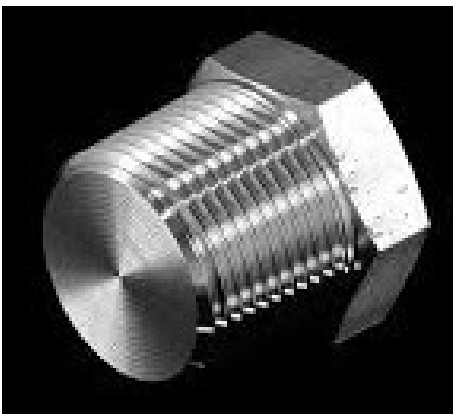

## **BH13091 HEAD COOLANT PLUG, THREADED**

**SKU:** xBH13091

Head Coolant Plug, Threaded

[Read More](#)

**Price:** \$10.50

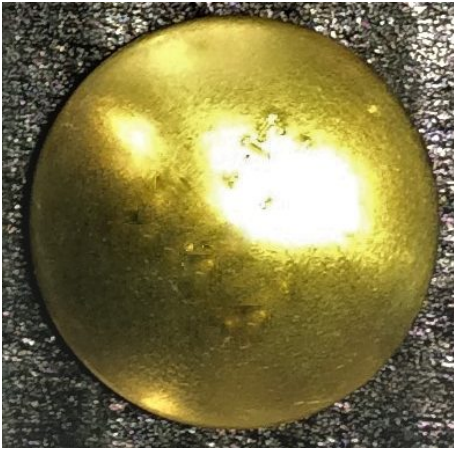

## BH12396 HEAD COOLANT PLUG, DISC STYLE, BRASS

**SKU:** BH12396

Brass Disc Style Head Coolant Plug

[Read More](#)

**Price:** \$3.78



## BH12096 HEAD COOLANT PLUG, DISC STYLE STEEL

**SKU:** BH12096

Head Coolant Plug, Disc Style Steel

[Read More](#)

**Price:** \$0.90



## BH11X93 BLOCK EXPANSION PLUGS (STEEL OR BRASS)

**SKU:** BH11X93

Block Expansion Plugs (each)

req. 6 per engine

[Read More](#)

**Price:** \$0.75 - \$3.50



## **BH11394 HEAD COOLANT PLUG, CUP STYLE BRASS**

**SKU:** BH11394

Brass Cup Style Head Coolant Plug (1 ea)

[Read More](#)

**Price:** \$2.93



## **BH11392 REAR CAM PLUG BRASS**

**SKU:** BH11392

Brass

[Read More](#)

**Price:** \$5.00





## **BH11094 HEAD COOLANT PLUG, CUP STYLE STEEL**

**SKU:** BH11094

Steel Cup Style Head Coolant Plug (1 ea)

[Read More](#)

**Price:** \$1.25



## **BH11092 REAR CAM PLUG STEEL**

**SKU:** BH11092

Steel

[Read More](#)

**Price:** \$0.95



## **BH11091 SMOG PASSAGE PRESS IN PLUGS**

**SKU:** BH11091

Smog Passage Press In Plugs

4 per engine

[Read More](#)

**Price:** \$0.75



## **BH11081 OIL GALLEY PRESS IN PLUGS**

**SKU:** BH11081

Oil Galley Press In Plugs

[Read More](#)

**Price:** \$0.40



## BH11011 CAD COMPANY BLOCK HARDWARE KIT

**SKU:** BH11011

Includes freeze plugs (brass), cam plug, all 7 galley plugs, 4 brass disc type head freeze plugs, 2 smog rail plugs, and block/ head dowel pins.

[Read More](#)

**Price:** \$53.72



## HARDWARE

Stock heads will have 3 plugs per head. Read  
More >>

2 per head will be the disc type (the hole will have a step so the plug can only go in so far). The third head plug will be one of the following:

- Disc style plug like the other 2 (mostly '68-'69 engines).
- The press in cup style (like a standard freeze plug) (some '68-'69 engines and 425 / 368 heads).

The 425 and most 368 heads will have one plug and one press in 90° heater outlet (no longer available) from the factory.

- Threaded head plugs (pipe thread) - usually one plug and one straight heater outlet (most '70-'76 engines)

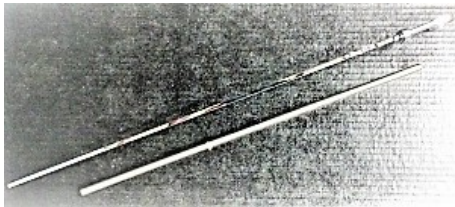

### OS40220 DIPSTICK TUBE POLISHED STAINLESS STEEL W/ CHROME DIPSTICK

**SKU:** OS40220

Dipstick Tube Polished stainless steel with chrome dipstick

[Read More](#)

**Price:** \$75.00

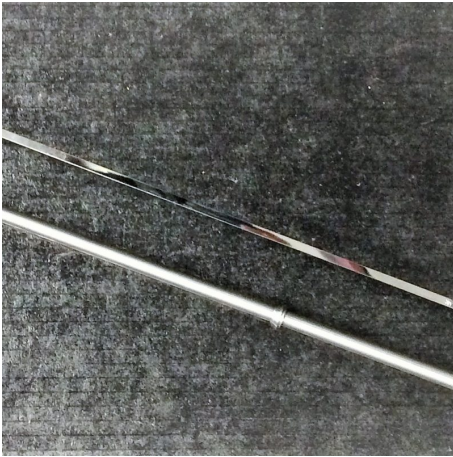

## OS40210 DIPSTICK TUBE STAINLESS STEEL W/ CHROME DIPSTICK

**SKU:** OS40210

Dipstick Tube Stainless steel with chrome dipstick

[Read More](#)

**Price:** \$49.00

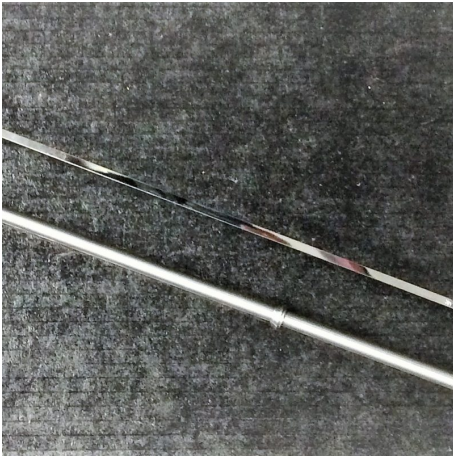

## OS40110 DIPSTICK TUBE CHROME W/ CHROME DIPSTICK

**SKU:** OS40110

Dipstick Tube chrome with chrome dipstick

[Read More](#)

**Price:** \$45.00



## OS40010 DIPSTICK TUBE UNIVERSAL, OE

**SKU:** OS40010

Universal, OE

[Read More](#)

**Price:** \$100.00

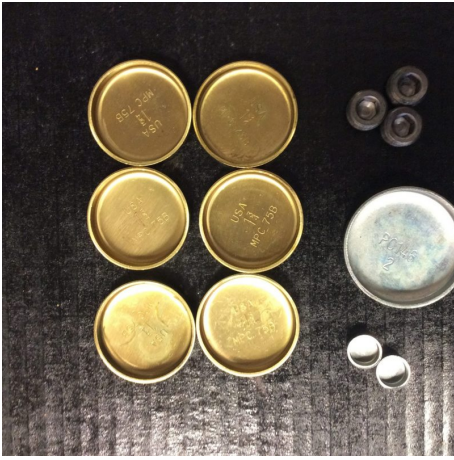

## **BH15301 FREEZE PLUG KIT (STANDARD) BRASS**

**SKU:** BH15301

Brass

[Read More](#)

**Price:** \$26.00



## **BH15001 FREEZE PLUG KIT (STANDARD) STEEL**

**SKU:** BH15001

Steel

[Read More](#)

**Price:** \$15.00





## BH13143 OIL GALLEY THREADED PLUG

**SKU:** BH13143

3/8" Pipe Thread Plugs

3-4 per engine - rear of main oil galleys, oil pressure access port above oil pump, and coolant port just below thermostat housing.

[Read More](#)

**Price:** \$0.40

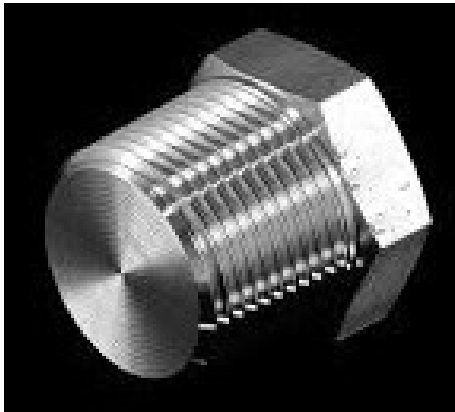

## BH13091 HEAD COOLANT PLUG, THREADED

**SKU:** xBH13091

Head Coolant Plug, Threaded

[Read More](#)

**Price:** \$10.50

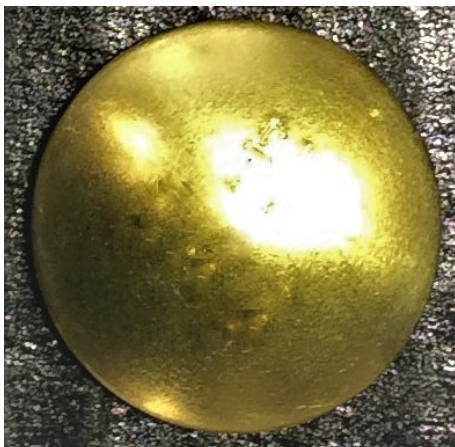

## BH12396 HEAD COOLANT PLUG, DISC STYLE, BRASS

**SKU:** BH12396

Brass Disc Style Head Coolant Plug

[Read More](#)

**Price:** \$3.78



## BH12096 HEAD COOLANT PLUG, DISC STYLE STEEL

**SKU:** BH12096

Head Coolant Plug, Disc Style Steel

[Read More](#)

**Price:** \$0.90



## BH11X93 BLOCK EXPANSION PLUGS (STEEL OR BRASS)

**SKU:** BH11X93

Block Expansion Plugs (each)

req. 6 per engine

[Read More](#)

**Price:** \$0.75 - \$3.50



## BH11394 HEAD COOLANT PLUG, CUP STYLE BRASS

**SKU:** BH11394

Brass Cup Style Head Coolant Plug (1 ea)

[Read More](#)

**Price:** \$2.93



## BH11392 REAR CAM PLUG BRASS

**SKU:** BH11392

Brass

[Read More](#)

**Price:** \$5.00



## BH11094 HEAD COOLANT PLUG, CUP STYLE STEEL

**SKU:** BH11094

Steel Cup Style Head Coolant Plug (1 ea)

[Read More](#)

**Price:** \$1.25





## BH11092 REAR CAM PLUG STEEL

**SKU:** BH11092

Steel

[Read More](#)

**Price:** \$0.95



## BH11091 SMOG PASSAGE PRESS IN PLUGS

**SKU:** BH11091

Smog Passage Press In Plugs

4 per engine

[Read More](#)

**Price:** \$0.75



## BH11081 OIL GALLEY PRESS IN PLUGS

**SKU:** BH11081

Oil Galley Press In Plugs

[Read More](#)

**Price:** \$0.40



## BH11011 CAD COMPANY BLOCK HARDWARE KIT

**SKU:** BH11011

Includes freeze plugs (brass), cam plug, all 7 galley plugs, 4 brass disc type head freeze plugs, 2 smog rail plugs, and block/ head dowel pins.

[Read More](#)

**Price:** \$53.72

# RINGS AND BEARINGS

Here at Cad Company, we have torture tested a variety of different rings and bearings under a wide range of conditions. In some cases, a specific product *is* recommended over others - but not always what you'd expect.

**Our Policy** - We only sell rings and bearings that we use in our turn-key engines, and are willing to stand behind with one of the best warranties in the crate engine business.

**Brands** - In our experience, there is not any real benefit of one brand over another in most cases (and many of them are the same parts in a different box, anyway) - we simply don't offer the ones you don't want. Some sizes are only available in 1 or 2 brands. If you want a specific brand, we would be happy to accommodate you (if they are available in the size you need), but be aware that specifying a brand may result in a higher price, as we don't have the benefit of negotiating the best price for a volume order.

**Cam Bearings** - Cam bearings are not all created equal. Durabond bearings are the best choice for most builds, but there are situations where something different is called for. The Cad Company exclusive grooved cam bearings (pictured) are made to our specs by Durabond. They incorporate a groove around the outside to allow oil to flow around the the second hole, which allows oil to enter the bearing on the loaded side, decreasing the chance of bearing failure due to high spring pressure. They also have an oil clearance closer to the middle of the factory spec, instead of tighter like the other off-the-shelf bearings, eliminating the need to clearance the bearings during assembly. If you have a problem with the cam bearings 'smearing', these bearings are probably the solution.

**Rod and Main Bearings** - There are 2 'series' of bearings available for rod bearings - 'P' and 'H'. 'H' bearings are generally intended for race cars. They are a harder alloy, and will survive more abuse in the way of things like being hammered on by detonation, but they tend to result in increased crankshaft wear due to reduced embeddability. 'Embeddability' is the property of bearings where contaminants embed into the bearing material, and reduced embeddability means that those contaminants stay on the surface, where they can scratch the

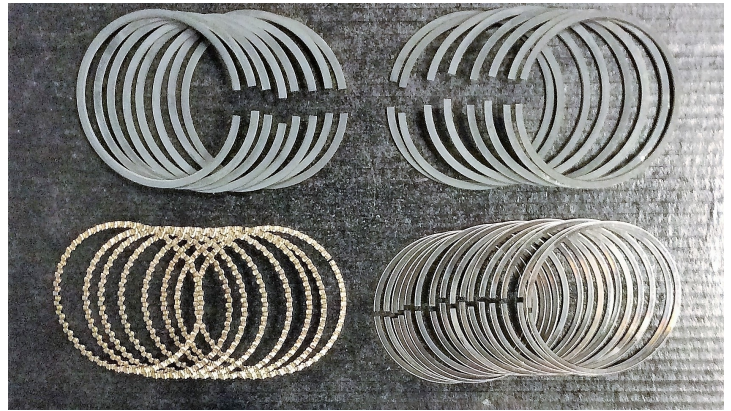



crankshaft. We do not recommend 'H' series bearings for anything but the most extreme drag racing applications.

**Coatings** - There is a lot of contradictory information out there about the various bearing coatings available. We have not been able to verify any of these claims on dyno test engines. At this time, we do not offer coated bearings.

**Rings** - We prefer moly rings for most N/A applications. They seat quick, last quite well, and are (relatively) reasonably priced. Care should be taken when selecting rings - check the piston description for special ring requirements before ordering. Also, be sure to check the instructions for ring end gap that come with your pistons - those usually take precedence over recommendations found elsewhere. When in doubt, ask.



## RB77102 CAM BEARINGS, CC3 GROOVED / DUAL HOLE STYLE

**SKU:** RB77102

Cam Bearings, CC3 grooved / dual hole style

[Read More](#)

**Price:** \$116.60



## RB77101 CAM BEARINGS, STOCK REPLACEMENT

**SKU:** RB77101

Cam bearings, stock replacement style

[Read More](#)

**Price:** \$52.28





## RB75110 CLEVITE 'H' SERIES ROD BEARINGS

**SKU:** RB75110

Clevite™ 'H' series rod bearings. Set of 8 pairs.

Recommended for competition use only.

[Read More](#)

**Price:** \$220.00



## RB75100 ROD BEARINGS FOR 472 / 500 / 425 / 368

**SKU:** RB75100

Rod Bearings - set of 8 pairs for 472 / 500 / 425 / 368.

[Read More](#)

**Price:** \$187.20

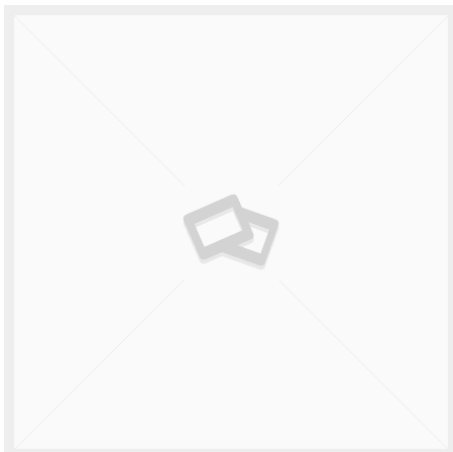

## RB73101 ROD AND MAIN BEARING KIT FOR 472 / 500 / 425 / 368

**SKU:** RB73101

Rod and main bearing kit for 472 / 500 / 425 / 368.

Includes: Main Bearings, set of 5 pairs, Rod bearings set of 8 pairs.

[Read More](#)

**Price:** \$402.93 ~~\$362.64~~



## RB71100 MAIN BEARINGS FOR 472 / 500 / 425 / 368

**SKU:** RB71100

Main Bearings, set of 5 pairs, for 472 / 500 / 425 / 368.

[Read More](#)

**Price:** \$215.73



## RB59170 PISTON RING SET FOR 425

**SKU:** RB59170

Piston rings for 425 engines.  
Standard width (5/64" / 5/64" / 3/16").

Complete set (1 set per engine).

We recommend Moly rings for most builds.

[Read More](#)

**Price:** \$105.17 - \$219.43

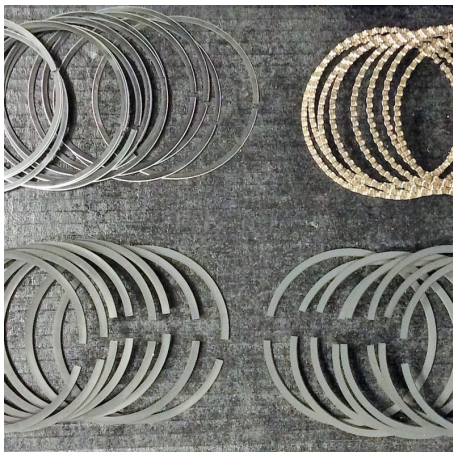

## RB59115 SKINNY (1/16") MOLY PISTON RING SET FOR 472 / 500 FOR CAD COMPANY FORGED PISTONS

**SKU:** RB59115

'Skinny' Piston rings for 472 / 500 engines with Cad Company forged pistons.  
Narrow width (1/16" / 1/16" / 3/16") - These rings ONLY fit forged pistons intended for skinny rings. Not applicable to stock replacement or KB pistons, or most forged pistons aside from the current Cad Company off-the-shelf forged pistons or something custom-made-to-order for these rings.

Complete set (1 set per engine).

Only available in Moly, and only available in the sizes listed.

[Read More](#)

**Price:** \$219.43

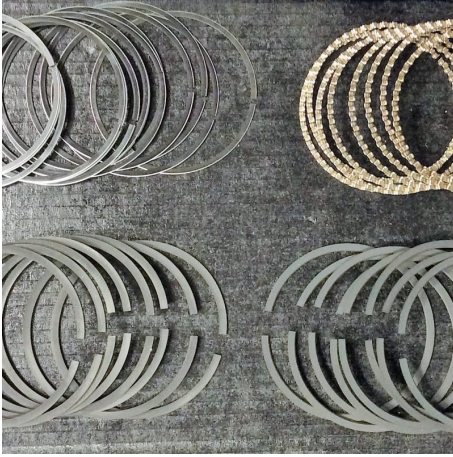

## RB59110 PISTON RING SET FOR 472 / 500

**SKU:** RB59110

Piston rings for 472 / 500 engines.  
Standard width (5/64" / 5/64" / 3/16") - for any off-the-shelf piston that does not specify narrow rings.

Complete set (1 set per engine).

We recommend Moly rings for most builds.

[Read More](#)

**Price:** \$120.00 - \$197.20



## OL21101 ASSEMBLY LUBE: CLEVITE™ BEARING GUARD

**SKU:** OL21101

8 oz. Assembly Lube: Clevite™ Bearing Guard

[Read More](#)

**Price:** \$13.50



# ROTATING PARTS

Rotating Parts



## RB55472 10:1 FORGED PISTONS - 472 CID W/ 76CC HEADS - D-DISH

**SKU:** RB55472

Cad Company forged pistons - D-Dish - 10:1 compression for 472 CID Cadillac engines with 76cc heads. With coated skirts. Price includes pins. Valve reliefs clear iron and aluminum heads. Uses 1/16" ring pack for reduced friction. Made in USA

[Read More](#)

**Price:** \$750.00



## RB55176 9:1 FORGED PISTONS - 500 CID - FLAT TOP

**SKU:** RB55176

Cad Company forged pistons - Flat Top - 9:1 compression for 500 CID Cadillac engines with 120cc heads (or 13:1 w/ 76cc heads). With coated skirts. Price includes pins. No valve reliefs. Uses 1/16" ring pack for reduced friction. Made in USA

[Read More](#)

**Price:** \$750.00





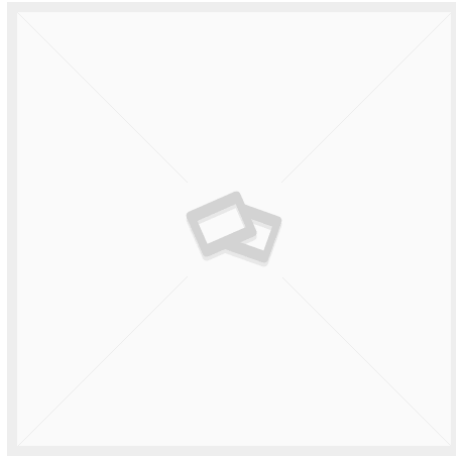

## RB55174 10:1 FORGED PISTONS - 500 CID W/ 120CC HEADS - DOMED

**SKU:** RB55174

Cad Company forged pistons - D-Dish - 10:1 compression for 500 CID Cadillac engines with 120cc heads, or 14:1 compression for 500 CID Cadillac engines with 76cc OE or ported OE heads. With coated skirts. Price includes pins. Valve reliefs clear iron and aluminum heads. Uses 1/16" ring pack for reduced friction. Made in USA

[Read More](#)

**Price:** \$750.00



## RB55172 10:1 FORGED PISTONS - 500 CID W/ 76CC HEADS - D-DISH

**SKU:** RB55172

Cad Company forged pistons - D-Dish - 10:1 compression for 500 CID Cadillac engines with 76cc heads. With coated skirts. Price includes pins. Valve reliefs clear iron and aluminum heads. Uses 1/16" ring pack for reduced friction. Made in USA

[Read More](#)

**Price:** \$750.00



## RB53116 KEITH BLACK PISTONS 9.8:1 FOR 472 W/76CC HEADS 1968-1973

**SKU:** RB53116

Keith Black Hypereutectic Piston 9.8:1 (76cc heads) 472CID .030,.040 & .060 fits 1968-1973

[Read More](#)

**Price:** \$781.12 \$660.09

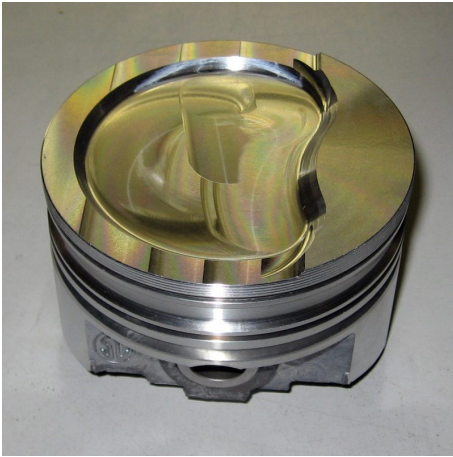

## RB53114 KEITH BLACK 10:1 PISTONS FOR 500CID

**SKU:** RB53114

[Read More](#)

**Price:** \$695.00

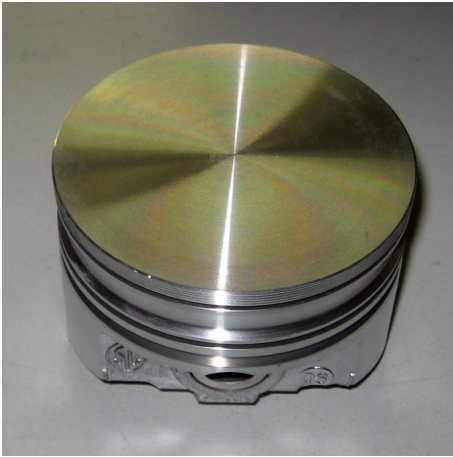

## RB53111 KEITH BLACK FLAT TOP PISTONS 1974-1976

**SKU:** rb53111

[Read More](#)

**Price:** ~~\$738.88~~ \$624.31



## RB51131 472 PISTONS 10:1 COMP RATIO W/76CC HEADS

**SKU:** RB51131

[Read More](#)

**Price:** \$575.00



## RB51120 CAST REPLACEMENT PISTONS WITH PINS FOR CADILLAC 472 AND 500 ENGINES

**SKU:** RB51120

**Cast replacement pistons** for Cadillac 472 and 500 Engines, with pins. Available in standard (STD), .020", .030", .040", and .060" over bore sizes.

[Read More](#)

**Price:** \$550.00



## RB51110 SILVOLITE CAST REPLACEMENT PISTONS WITH PINS FOR CADILLAC 472, 500, AND 425 ENGINES

**SKU:** RB51110

**Silvolite cast replacement pistons** for Cadillac 472, 500, and 425 Engines, with pins. Available in standard (STD), .020", .030", .040", and .060" over bore sizes.

[Read More](#)

**Price:** \$595.00

## RB40111 CRANK KEY

**SKU:** RB40111

**Crankshaft key** for timing gear / crank hub for Cadillac 472 / 500 / 425 / 368 engines. The correct factory style key. Nothing special, just the right thing.

[Read More](#)

**Price:** \$6.00





## RB35112 HD FORGED H BEAM RODS

**SKU:** RB35112

Set of 8 new heavy-duty forged I-beam rods, w/ 7/16" cap screws and bushed for floating pins.

Recommended for N/A or boosted engines over 700 HP.

[Read More](#)

**Price:** \$695.00



## RB33113 HD FORGED I BEAM RODS

**SKU:** RB33113

Set of 8 new heavy-duty forged I-beam rods, w/ 7/16" cap screws and bushed for floating pins.

Recommended for engines over 700 HP.

[Read More](#)

**Price:** \$595.00



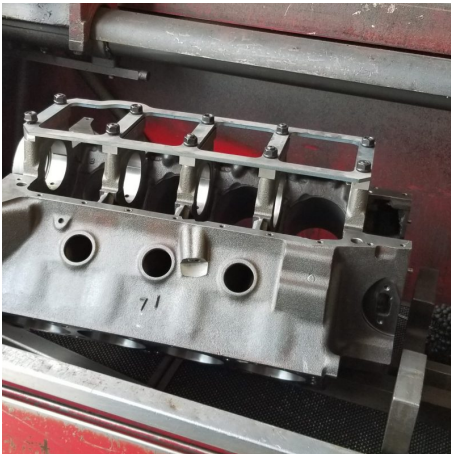

## RB19123 MAIN GIRDLE KIT WITH CAP SUPPORTS

**SKU:** RB19123

**Halo main girdle kit with cap supports**

[Read More](#)

**Price:** \$499.00

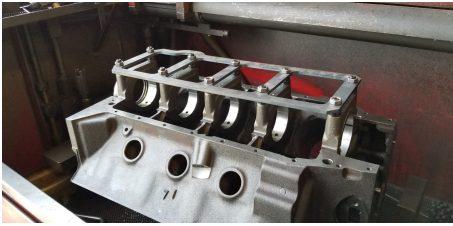

## RB19121 HALO MAIN GIRDLE KIT

**SKU:** RB19121

**Halo main girdle kit**

[Read More](#)

**Price:** \$350.00



## PB12306 HARMONIC DAMPER W/ HUB, SFI CERTIFIED

**SKU:** PB12306

**SFI Certified One-Piece Harmonic Vibration Damper**

[Read More](#)

**Price:** \$390.00

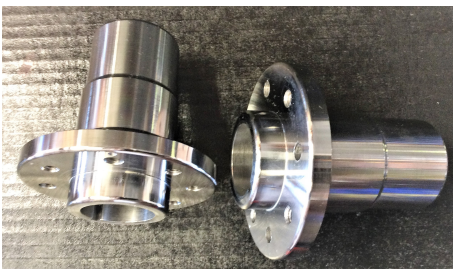
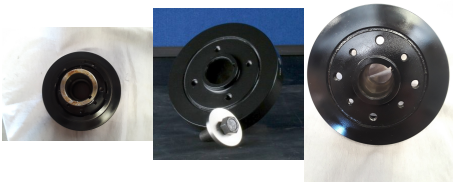

## PB11202 BILLET STEEL CRANK HUB (OFFSET)

**SKU:** PB11202

**Offset Billet Steel Crank Hub**

This hub has offset flange spacing for correct pulley alignment using non-dampener pulleys with aftermarket performance dampeners that go between the pulley and hub, with the standard 4-bolt pulley pattern. This hub fits all 472 / 500 / 425 / 368 engines, and maintains the correct press-fit.

[Read More](#)

**Price:** \$190.00

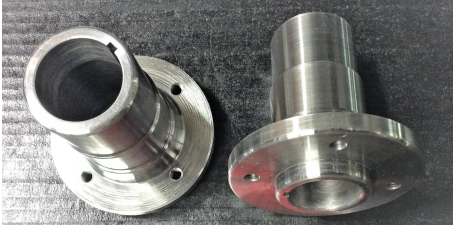

## PB11201 BILLET STEEL CRANK HUB

**SKU:** PB11201

Standard Replacement Billet Steel Crank Hub

This hub is a direct replacement for the stock crank hub, in tougher billet steel form. Suitable for any application for which the factory hub will fit, but you need a replacement (due to a lost or damaged factory hub), or something tougher. This hub fits all 472 / 500 / 425 / 368 engines, and maintains the correct press-fit.

[Read More](#)

**Price:** \$250.00

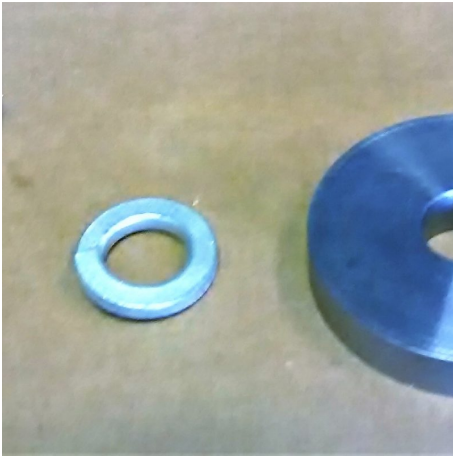

## PB11122 CRANK HUB BOLT AND WASHER KIT

**SKU:** PB11122

**Crank Hub Bolt and Washer Kit** Correct washer to clear the pulley. Fits the front of the crankshaft, to positively retain the crank hub or damper (or dampener or balancer, as some folks call them).

[Read More](#)

**Price:** \$15.00



## PB11113 CRANK HUB SLEEVE

**SKU:** PB11113

Crank hub sealing surface repair sleeve.

[Read More](#)

**Price:** \$95.00



## OS10151 CRANK SCRAPER

**SKU:** OS10151

[Read More](#)

**Price:** \$55.00



# CRANKSHAFTS, STROKER KITS, CRANK HUBS, AND VIBRATION DAMPENERS

Crankshafts, Stroker Kits, Crank Hubs, and  
Vibration Dampeners [Read More >>](#)

Cad Company does not sell stroked stock cranks by themselves - we only sell them as complete rotating assemblies. We do sell reconditioned and machined stock cranks, ready to install and aftermarket billet cranks (the same ones in our billet crank stroker kits, as well as made-to order).

Cad Company's stroker kits utilizing stroked stock cranks incorporate all that we have learned over 40+ years of building performance Cadillac engines, and our current recipe has been torture tested to nearly 2k HP. Most home-brew stroker cranks fail sooner or later (usually sooner) on engines making any real power - it's not as simple to build a reliable stroker crank as some would have you believe, but we have worked out the details to offer you a reasonably priced rotating assembly, without having to go through the trial and error method of figuring out what fails and what doesn't.

We offer 2 crank hub options. In most cases you will want the 'standard' hub. The offset hub was primarily for pulley alignment with an obsolete (no longer available) aftermarket dampener. Most '73-older (3-groove) factory pulleys are back-cut to provide clearance for the factory vibration dampener. Some '73-older and most '74-newer (2-groove) factory pulleys, as well as all aftermarket pulleys, are not. All factory hubs have the same spacing, and that's what the 'standard' dampener matches. If you want to use the factory dampener with a late or aftermarket pulley, the offset hub is your best bet, but it will generally require manually shimming the pulley for proper belt alignment (with a stock or standard replacement hub, you would have to machine the clearance into the back of the pulley, IF the pulley you are using has room to do so). You cannot simply use the offset hub and pull the hub outward for belt alignment, as the hub must be pressed on as far as it will go - there are a variety of likely failures if the hub is not pressed on all the way, it's just a matter of what fails first.

The only vibration dampener currently available is sold as a complete unit, with it's own unique hub (pre-assembled together). The



mounting face provides the same pulley alignment as the factory and 'standard' replacement hubs.

## RB40111 CRANK KEY

**SKU:** RB40111

**Crankshaft key** for timing gear / crank hub for Cadillac 472 / 500 / 425 / 368 engines. The correct factory style key. Nothing special, just the right thing.

[Read More](#)

**Price:** \$6.00

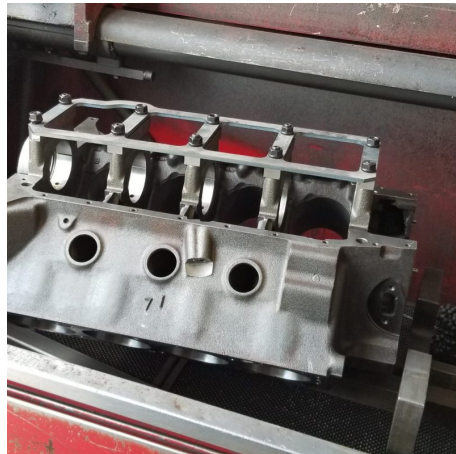

## RB19123 MAIN GIRDLE KIT WITH CAP SUPPORTS

**SKU:** RB19123

**Halo main girdle kit with cap supports**

[Read More](#)

**Price:** \$499.00

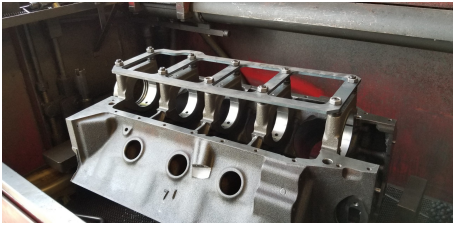

## RB19121 HALO MAIN GIRDLE KIT

**SKU:** RB19121

**Halo main girdle kit**

[Read More](#)

**Price:** \$350.00



## PB12306 HARMONIC DAMPER W/ HUB, SFI CERTIFIED

**SKU:** PB12306

**SFI Certified One-Piece Harmonic Vibration Damper**

[Read More](#)

**Price:** \$390.00

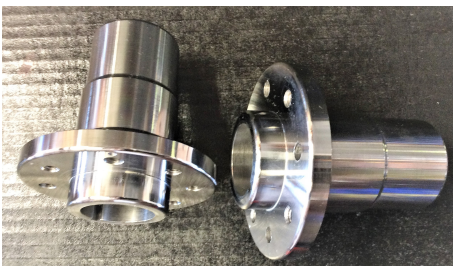
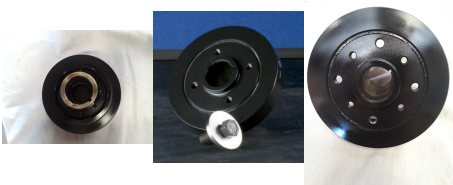

## PB11202 BILLET STEEL CRANK HUB (OFFSET)

**SKU:** PB11202

**Offset Billet Steel Crank Hub**

This hub has offset flange spacing for correct pulley alignment using non-dampener pulleys with aftermarket performance dampeners that go between the pulley and hub, with the standard 4-bolt pulley pattern. This hub fits all 472 / 500 / 425 / 368 engines, and maintains the correct press-fit.

[Read More](#)

**Price:** \$190.00





## PB11122 CRANK HUB BOLT AND WASHER KIT

**SKU:** PB11122

**Crank Hub Bolt and Washer Kit** Correct washer to clear the pulley. Fits the front of the crankshaft, to positively retain the crank hub or damper (or dampener or balancer, as some folks call them).

[Read More](#)

**Price:** \$15.00



## PB11113 CRANK HUB SLEEVE

**SKU:** PB11113

Crank hub sealing surface repair sleeve.

[Read More](#)

**Price:** \$95.00



# MAIN STUDS, GIRDLES, AND SCRAPERS

Main bolts and studs, Main Girdles, and Crank  
Scrapers

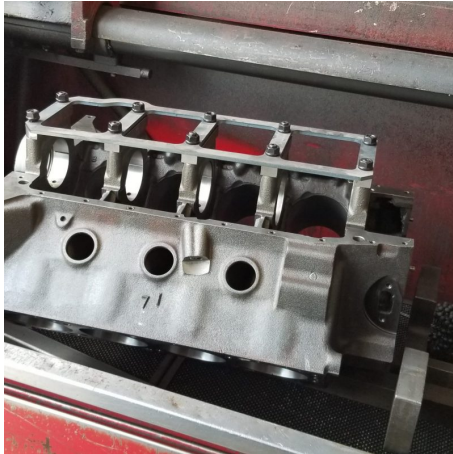

## RB19123 MAIN GIRDLE KIT WITH CAP SUPPORTS

**SKU:** RB19123

**Halo main girdle kit with cap supports**

[Read More](#)

**Price:** \$499.00

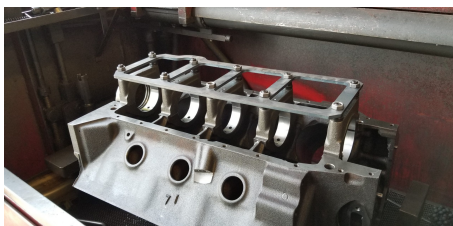

## RB19121 HALO MAIN GIRDLE KIT

**SKU:** RB19121

**Halo main girdle kit**

[Read More](#)

**Price:** \$350.00



## OS10151 CRANK SCRAPER

**SKU:** OS10151

[Read More](#)

**Price:** \$55.00



# RODS AND PISTONS

Rod/ Piston Combos



## RB55472 10:1 FORGED PISTONS - 472 CID W/ 76CC HEADS - D-DISH

**SKU:** RB55472

Cad Company forged pistons - D-Dish - 10:1 compression for 472 CID Cadillac engines with 76cc heads. With coated skirts. Price includes pins. Valve reliefs clear iron and aluminum heads. Uses 1/16" ring pack for reduced friction. Made in USA

[Read More](#)

**Price:** \$750.00



## RB55176 9:1 FORGED PISTONS - 500 CID - FLAT TOP

**SKU:** RB55176

Cad Company forged pistons - Flat Top - 9:1 compression for 500 CID Cadillac engines with 120cc heads (or 13:1 w/ 76cc heads). With coated skirts. Price includes pins. No valve reliefs. Uses 1/16" ring pack for reduced friction. Made in USA

[Read More](#)

**Price:** \$750.00



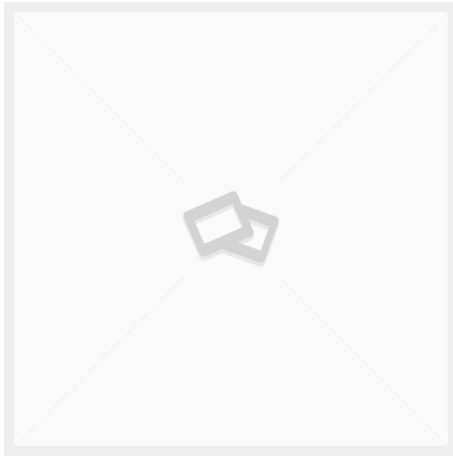

## RB55174 10:1 FORGED PISTONS - 500 CID W/ 120CC HEADS - DOMED

**SKU:** RB55174

Cad Company forged pistons - D-Dish - 10:1 compression for 500 CID Cadillac engines with 120cc heads, or 14:1 compression for 500 CID Cadillac engines with 76cc OE or ported OE heads. With coated skirts. Price includes pins. Valve reliefs clear iron and aluminum heads. Uses 1/16" ring pack for reduced friction. Made in USA

[Read More](#)

**Price:** \$750.00



## RB55172 10:1 FORGED PISTONS - 500 CID W/ 76CC HEADS - D-DISH

**SKU:** RB55172

Cad Company forged pistons - D-Dish - 10:1 compression for 500 CID Cadillac engines with 76cc heads. With coated skirts. Price includes pins. Valve reliefs clear iron and aluminum heads. Uses 1/16" ring pack for reduced friction. Made in USA

[Read More](#)

**Price:** \$750.00



## RB53116 KEITH BLACK PISTONS 9.8:1 FOR 472 W/76CC HEADS 1968-1973

**SKU:** RB53116

Keith Black Hypereutectic Piston 9.8:1 (76cc heads) 472CID .030,.040 & .060 fits 1968-1973

[Read More](#)

**Price:** \$781.12 \$660.09



## RB53114 KEITH BLACK 10:1 PISTONS FOR 500CID

**SKU:** RB53114

[Read More](#)

**Price:** \$695.00

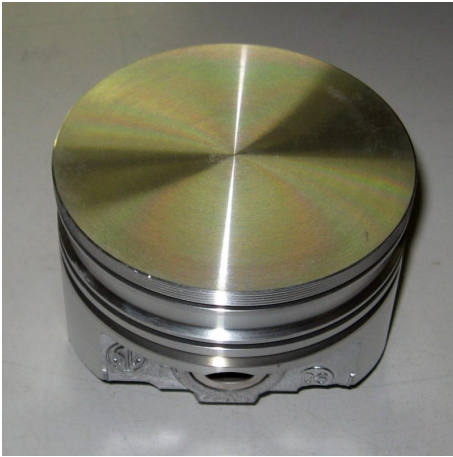

## RB53111 KEITH BLACK FLAT TOP PISTONS 1974-1976

**SKU:** rb53111

[Read More](#)

**Price:** ~~\$738.88~~ \$624.31



## RB51131 472 PISTONS 10:1 COMP RATIO W/76CC HEADS

**SKU:** RB51131

[Read More](#)

**Price:** \$575.00



## RB51120 CAST REPLACEMENT PISTONS WITH PINS FOR CADILLAC 472 AND 500 ENGINES

**SKU:** RB51120

**Cast replacement pistons** for Cadillac 472 and 500 Engines, with pins Available in standard (STD), .020", .030", .040", and .060" over bore sizes.

[Read More](#)

**Price:** \$550.00



## RB51110 SILVOLITE CAST REPLACEMENT PISTONS WITH PINS FOR CADILLAC 472, 500, AND 425 ENGINES

**SKU:** RB51110

**Silvolite cast replacement pistons** for Cadillac 472, 500, and 425 Engines, with pins. Available in standard (STD), .020", .030", .040", and .060" over bore sizes.

[Read More](#)

**Price:** \$595.00



## RB35112 HD FORGED H BEAM RODS

**SKU:** RB35112

Set of 8 new heavy-duty forged I-beam rods, w/ 7/16" cap screws and bushed for floating pins.

Recommended for N/A or boosted engines over 700 HP.

[Read More](#)

**Price:** \$695.00



## RB33113 HD FORGED I BEAM RODS

**SKU:** RB33113

Set of 8 new heavy-duty forged I-beam rods, w/ 7/16" cap screws and bushed for floating pins.

Recommended for engines over 700 HP.

[Read More](#)

**Price:** \$595.00





# INDEX

## B

BH11011 Cad Company Block Hardware Kit 21, 29  
BH11081 Oil Galley Press In Plugs 20, 28  
BH11091 Smog Passage Press In Plugs 19, 28  
BH11092 Rear Cam Plug Steel 19, 28  
BH11094 Head Coolant Plug, Cup Style Steel 19, 27  
BH11392 Rear Cam Plug Brass 18, 27  
BH11394 Head Coolant Plug, Cup Style Brass 18, 26  
BH11X93 Block Expansion Plugs (Steel or Brass) 17, 26  
BH12096 Head Coolant Plug, Disc Style Steel 17, 26  
BH12396 Head Coolant Plug, Disc Style, Brass 17, 25  
BH13091 Head Coolant Plug, Threaded 16, 25  
BH13143 Oil Galley Threaded Plug 16, 24  
BH15001 Freeze Plug Kit (Standard) Steel 16, 24  
BH15301 Freeze Plug Kit (Standard) Brass 15, 24

## O

OL21101 Assembly Lube: Clevite™ Bearing Guard 15, 34  
OS10151 Crank Scraper 15, 43, 49  
OS40010 Dipstick Tube Universal, OE 14, 23  
OS40110 Dipstick Tube Chrome w/ Chrome Dipstick 14, 23  
OS40210 Dipstick Tube Stainless Steel w/ Chrome Dipstick 14, 23  
OS40220 Dipstick Tube Polished Stainless Steel w/ Chrome Dipstick 13, 22

## P

PB11113 Crank Hub Sleeve 13, 42, 47  
PB11122 Crank Hub Bolt and Washer Kit 13, 42, 47  
PB11201 Billet Steel Crank Hub 12, 42  
PB11202 Billet Steel Crank Hub (offset) 12, 41, 46  
PB12306 Harmonic Damper w/ Hub, SFI certified 11, 41, 46

## R

RB19121 Halo Main Girdle Kit 11, 41, 46, 48  
RB19123 Main Girdle Kit With Cap Supports 11, 40, 45, 48  
RB33113 HD Forged I Beam Rods 9, 39, 54  
RB35112 HD Forged H Beam Rods 9, 39, 53  
RB40111 Crank Key 9, 38, 45  
RB51110 Silvolite Cast Replacement Pistons With Pins for Cadillac 472, 500, and 425 Engines 8, 38, 53  
RB51120 Cast Replacement Pistons With Pins for Cadillac 472 and 500 Engines 8, 38, 53  
RB51131 472 Pistons 10:1 Comp Ratio W/76cc heads 8, 37, 52  
RB53111 Keith Black Flat Top Pistons 1974-1976 7, 37, 52  
RB53114 Keith Black 10:1 Pistons For 500CID 7, 37, 52  
RB53116 Keith Black Pistons 9.8:1 for 472 W/76cc Heads 1968-1973 7, 36, 51  
RB55172 10:1 Forged Pistons - 500 CID w/ 76cc Heads - D-Dish 6, 36, 51  
RB55174 10:1 Forged Pistons - 500 CID w/ 120cc Heads - Domed 6, 36, 51  
RB55176 9:1 Forged Pistons - 500 CID - Flat Top 6, 35, 50  
RB55472 10:1 Forged Pistons - 472 CID w/ 76cc Heads - D-Dish 5, 35, 50  
RB59110 Piston Ring Set for 472 / 500 5, 34  
RB59115 Skinny (1/16") Moly Piston Ring Set for 472 / 500 for Cad Company Forged Pistons 5, 33  
RB59170 Piston Ring Set for 425 4, 33  
RB71100 Main Bearings for 472 / 500 / 425 / 368 4, 33  
RB73101 Rod and Main Bearing Kit for 472 / 500 / 425 / 368 4, 32  
RB75100 Rod Bearings for 472 / 500 / 425 / 368 3, 32  
RB75110 Clevite 'H' Series Rod Bearings 3, 32  
RB77101 Cam Bearings, Stock Replacement 3, 31  
RB77102 Cam Bearings, CC3 Grooved / Dual Hole Style 2, 31

## V

VT13174 True Roller Timing Chain Set 2