



TM



PARTS



CATALOG





TABLE OF CONTENTS

Complete engines	3
Garage Sale	5
Uncategorized	7
Air and Fuel Delivery	8
Air Cleaners	37
Blower Kit	42
Carburetors	43
Cylinder Heads	48
Cylinder Head Fasteners, Parts, and Kits	57
EFI Fuel Injection	59
Fuel Lines	60
Fuel Pumps	63
Intake Manifolds	69
Cadware	74
Cooling System	76
Plugs	85
Radiator	89
Thermostats and Housings	90
Water Pumps	93
Driveline	95
Flex Plates, Flywheels, and Ring Gears	105
Starters	111
Transmission Adapters	114
Transmission Parts	117
Exhaust	118
Exhaust Manifolds	130
Headers	135
Gaskets	142
Engine Gasket Sets	160
Head Gaskets	162
Lower Engine Gaskets	165
Sealants	169
Upper Engine Gaskets	171
Hardware and Fasteners	180
External Parts Fasteners	189
Long Block Fasteners	194
Ignition Systems	197
Distributor Components	210
Distributors	215
Electronic Conversion Kits for Points Distributors	218
Ignition Coils	219
Ignition Control Boxes and Accessories	222
Spark Plug Wires and Looms	224
Oil Lube and Chemicals	228
Oiling System	229
Dipsticks and Tubes	237



Filters	239
Oil Pans	241
Oil Pickup Tubes	244
Oil Pumps	246
Overhaul, Rotating, and Bottom End Parts	249
Hardware	269
Rings and Bearings	277
Rotating Parts	282
Crankshafts, Stroker Kits, Crank Hubs, and Vibration Dampeners ...	291
Main Studs, Girdles, and Scrapers	295
Rods and Pistons	297
Pulleys, Brackets, and Accessories	302
AC Components	319
Alternator	321
Belts	324
Brackets	325
Crank and Water Pump Pulleys	327
Power Steering	331
Pulleys and Related Parts	336
Serpentine Drive Kits and Parts	344
Swap Components, Adapters, and Motor Mounts	352
Swap Kits	360
Motor Mounts and Kits	361
Other Swap Components	366
Tools and Supplies	369
Valve Covers	373
Bits and Pieces	381
Cast Aluminum Valve Covers	385
Chrome Valve Covers	387
Early Cadillac Valve Covers	388
Valvetrain	390
Cams & Kits	425
Lifters	445
New Replacement Timing Covers	446
Rocker Systems	448
Full Shaft Rocker Assemblies	455
OEM Style (T-Pedestal) Rocker Components	458
Pushrods	460
Timing	463
Valve Spring Kits	466
Valve Stem Seals	468
Valve Stem Seals	469
Valves	470
Wiring and Switches	473
Core Parts	475
Air and Fuel Delivery	488
Rotating and Bottom End Parts	492
Oil Pans	493
Pulleys Brackets and Accessories	495
Reman Exhaust Manifolds	499

COMPLETE ENGINES

Unlock the Potential: Are you ready to unleash the full potential of your ride? Take the first step towards automotive greatness with the Cadillac 472/500 Engine. Whether you're a performance enthusiast, a classic car collector, or simply someone who appreciates the finer things in life, this engine is sure to exceed your expectations and elevate your driving experience to new heights.



CC95 CADILLAC 472 COMPLETE ENGINE

SKU: CC 95 Complete 472 Engine

[Read More](#)

Price: \$14,500.00



CADILLAC 500 ENGINE CC89

SKU: CC 89 Complete Engine

[Read More](#)

Price: \$14,500.00

GARAGE SALE

Cad Company Garage Sale!

Looking for a deal? These are orphans, obsolete parts, 1-offs that need a home, defective-but-usable new parts, and good used parts, at great prices.

All sales are final, no warranty expressed or implied.

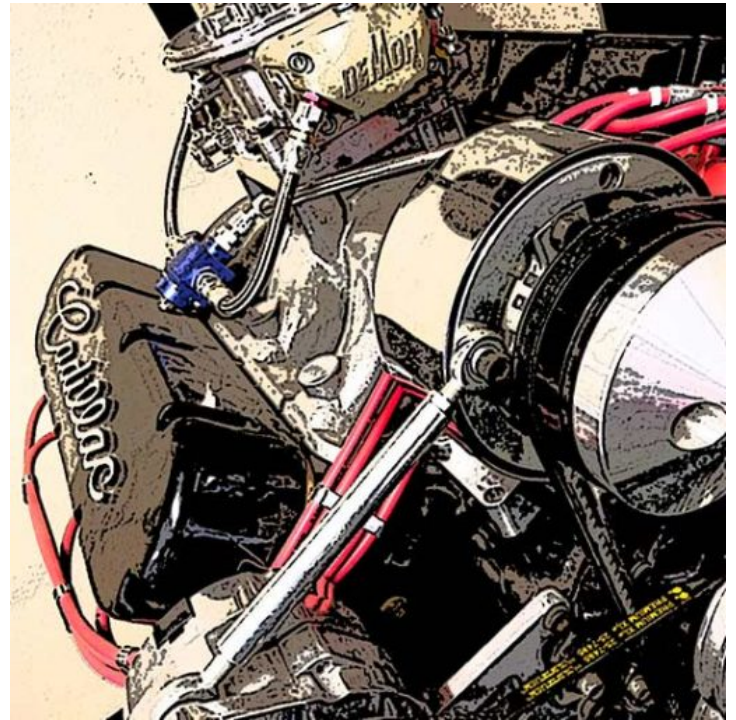

HOGAN INTAKE - LAND SPEED EXTRA

SKU: Hogan Intake

[Read More](#)

Price: \$3,500.00

DUAL SYNC DISTRIBUTOR

SKU: N/A

[Read More](#)

Price: \$800.00

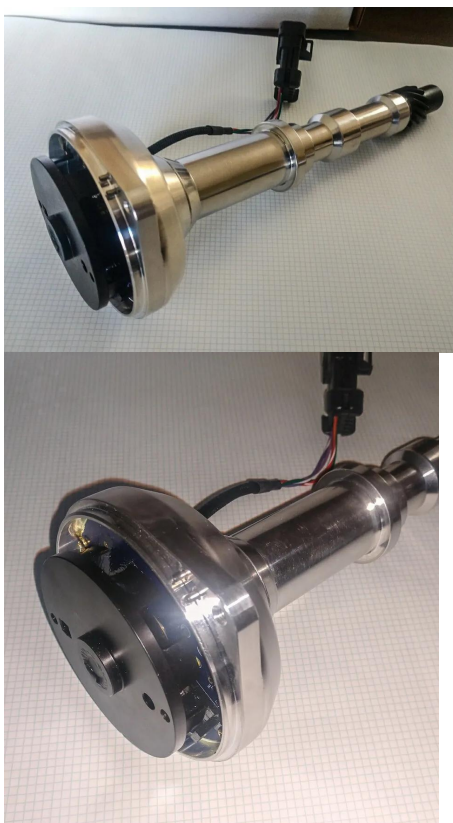



CC95 CADILLAC 472 COMPLETE ENGINE

SKU: CC 95 Complete 472 Engine

[Read More](#)

Price: \$14,500.00



CADILLAC 500 ENGINE CC89

SKU: CC 89 Complete Engine

[Read More](#)

Price: \$14,500.00



UNCATEGORIZED

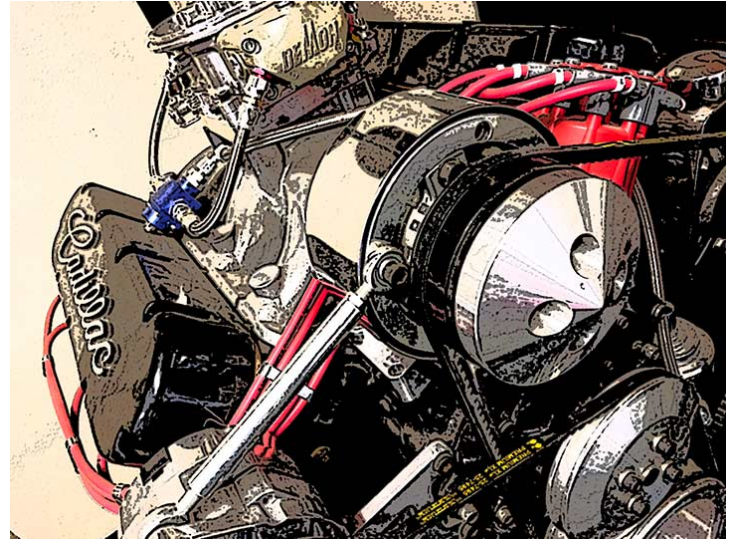

RB19124 STOCK PAN GIRDLE SET UP

SKU: RB19124

[Read More](#)

Price: \$900.00

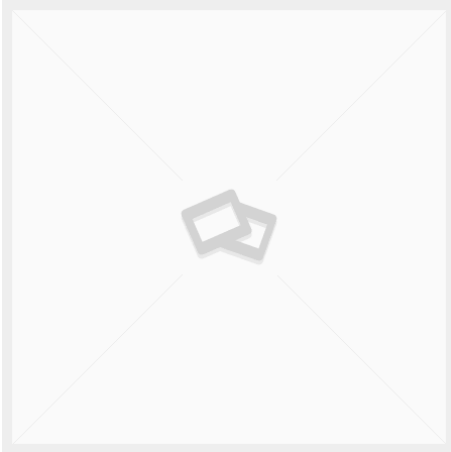

AIR AND FUEL DELIVERY



VT93033 GROMMET FOR AIR CLEANER HOUSING

SKU: VT93033

[Read More](#)

Price: \$5.00



PB34000 R4 BRACKET KIT BILLET ALUMINUM

SKU: PB34000

Billet Aluminum

[Read More](#)

Price: \$324.00



HOGAN INTAKE - LAND SPEED EXTRA

SKU: Hogan Intake

[Read More](#)

Price: \$3,500.00

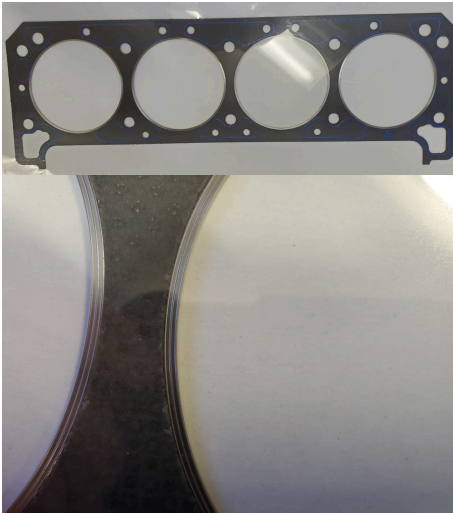

GS511056 CUT RING HEAD GASKET FOR 472 / 500

SKU: GS51105.6

472 / 500 Cadillac Cut Ring Head Gasket

Cut ring head gasket for bore sizes up to 4.360" (.060" over) or 4.420" (.120" over). Choose a size when ordering.

These are the best sealing available for high cylinder pressure applications.

[Read More](#)

Price: \$175.00

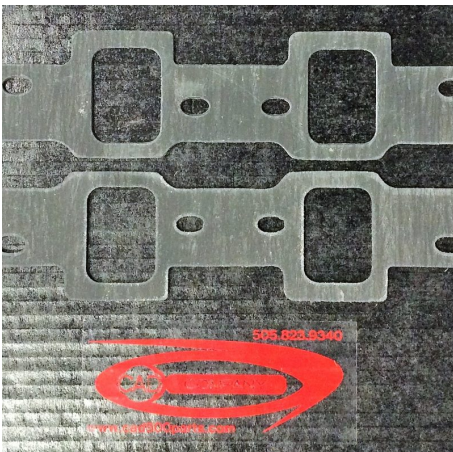

GS21122 BOOGIEMAN™ COMPOSITE INTAKE GASKETS

SKU: GS21122



BoogieMan™ Composite Intake Gaskets

Recommended for use with wide-port BoogieMan™ heads and / or intakes.

Won't come apart when wet.

High quality composite gasket material. Safe for aluminum heads and intakes.

Color may vary.

For iron heads or non-BoogieMan aluminum heads, order [GS21112](#)



Made in USA

[Read More](#)

Price: \$35.00

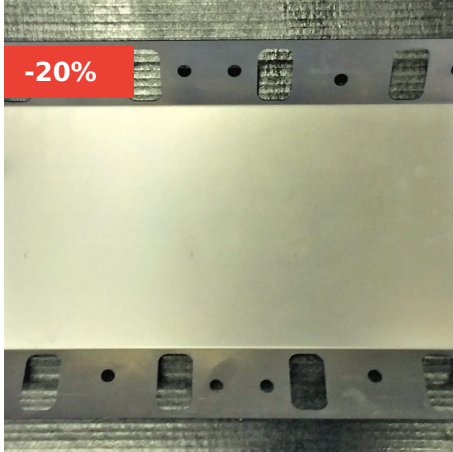

GS21102 HEAVY-DUTY LASER CUT STEEL VALLEY PAN

SKU: GS21102

Heavy-Duty Laser Cut Steel Valley Pan

[Read More](#)

Price: ~~\$50.00~~ \$40.00

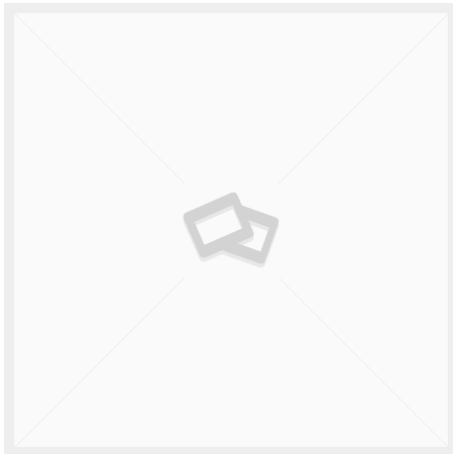

GS10213 CARB GASKET, 1/4" THICK '70-'84

SKU: GS10213

Carb Gasket '70-'84 Q-jet w/o exhaust at carb base

1/4" thick insulator style.

[Read More](#)

Price: \$8.00

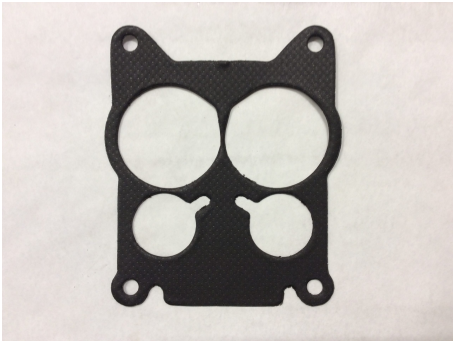

GS10212 CARB GASKET '70-'84

SKU: GS10212

Carb Gasket '70-'84

[Read More](#)

Price: \$8.00

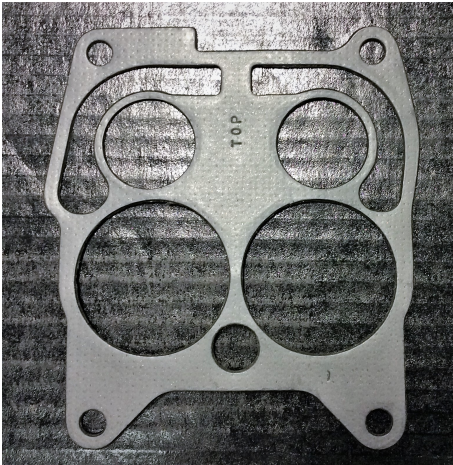

GS10211 CARB GASKET '67-'70

SKU: GS10211

Carb Gasket '67-'70

[Read More](#)

Price: \$8.00

BH15013 FREEZE PLUG KIT FOR 425 HEADS

SKU: N/A

Freeze Plug Kit for 425 Heads

Kit includes 4 disc type plugs and 2 cup type plugs (does not include water outlet).

1 Kit per engine

[Read More](#)

Price: \$5.00 - \$20.00





AF96225 SPUN ALUMINUM AIR CLEANER KIT - TALL

SKU: AF96201

Tall Spun Aluminum Air Cleaner Kit

Includes spun aluminum base, top, 5" air filter element, and stud kit.

This air cleaner kit sits down deep over the carb and has a 5" tall filter for maximum airflow and a killer look. Clears Q-jets great, but will not clear most aftermarket carbs without a carb-to-air-cleaner spacer.

Hand spun base and lid looks and flows great.

[Read More](#)

Price: \$90.00



AF96225 SPUN ALUMINUM AIR CLEANER KIT - SHORT

SKU: AF96225

Short Spun Aluminum Air Cleaner Kit

Includes spun aluminum base, top, 2.5" air filter element, and stud kit.

This air cleaner kit sits down deep over the carb and gives you maximum hood clearance with a standard 14" round air filter. Clears Q-jets great, but will not clear most aftermarket carbs.

Hand spun base and lid looks and flows great.

[Read More](#)

Price: \$80.00



AF96104 CHROME AIR CLEANER KIT

SKU: AF96104

flat base with riser, includes filter

[Read More](#)

Price: \$65.00



AF96102 CHROME AIR CLEANER KIT (DROP BASE)

SKU: AF96102

drop base, includes filter

[Read More](#)

Price: \$45.00



AF96101 CHROME AIR CLEANER KIT

SKU: AF96101

flat base, includes filter

[Read More](#)

Price: \$30.00



AF93425 K&N 2 1/2" AIR FILTER

SKU: AF93425

Recommended for most aftermarket 14" air cleaner assemblies

[Read More](#)

Price: \$90.00





AF93401 K&N AIR FILTER

SKU: AF93401

K&N Air Filter For stock air cleaner assemblies

[Read More](#)

Price: \$95.00



AF93250 MOROSO 5" AIR FILTER

SKU: AF93250

Recommended for our spun aluminum deep dish air cleaner assembly

[Read More](#)

Price: \$50.00



AF92010 SPUN ALUMINUM AIR CLEANER TOP WITH INTEGRAL AIR DEFLECTION CONE

SKU: AF92010

Fits most 14" air cleaners

[Read More](#)

Price: ~~\$35.00~~ \$30.00

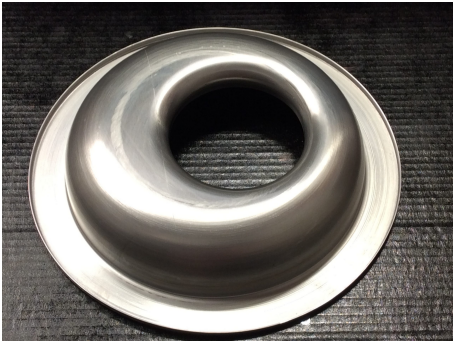

AF91011 SPUN ALUMINUM AIR CLEANER DROP BASE, OFFSET MOUNT

SKU: AF91011

Spun Aluminum Air Cleaner Drop Base, Offset mount

[Read More](#)

Price: \$35.00



AF91010 AIR FILTER DROPPED BASE 14"

SKU: AF91010

[Read More](#)

Price: ~~\$39.95~~ \$35.00



AF90020 AIR CLEANER STUD KIT, UNIVERSAL

SKU: AF90020

Not for offset air cleaners

[Read More](#)

Price: \$10.00

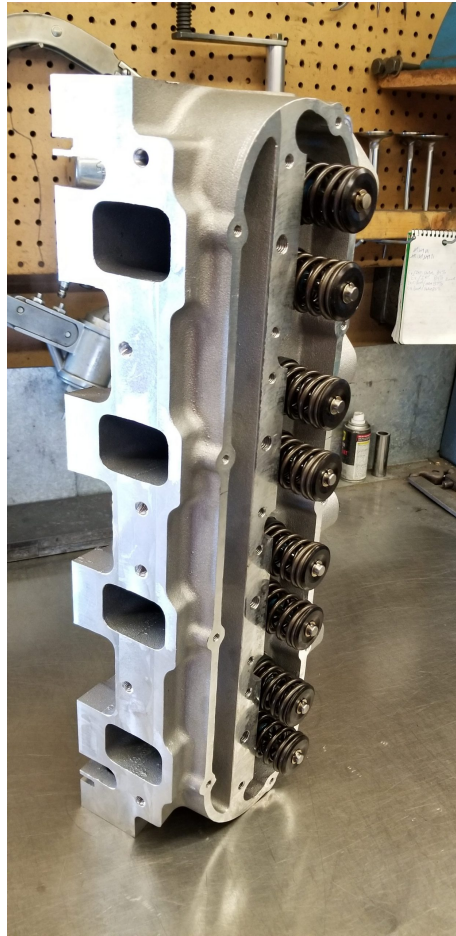

AF85400 BOOGIEMAN™ ALUMINUM HEADS

SKU: AF85400

The world famous "BoogieMan" cylinder heads are in stock and ready to ship. This is the next step in the "Boogie-Man" line. Using an American made casting, CNC machining, and a top-of-the-line seat and guide machine, we have the absolute best cylinder head for a high performance 472 or 500 Cadillac, on the market today. They have 70cc combustion chamber chambers (adds about 1/2 a point of CR over 76cc iron heads), and include 2.25" / 1.8" valves (the same high-grade stainless steel and production methods used for our iron head valves). These heads have been used on numerous applications from daily drivers to full race applications, and they weigh in at 32 Lbs. (vs. the stock iron head's average weight of 62 Lbs.) per head.

[Read More](#)

Price: \$3,600.00



AF85141 FACTORY REPLACEMENT ALUMINUM HEADS

SKU: AF85141

These are the evolved version of the old Bulldog aluminum heads. They have 76cc combustion chambers and include 2.19 / 1.90 stainless valves, and weigh in at 38 Lbs. per head, vs 62 Lbs. per head for your average iron head.

Performance wise, they fall in between our Pro Street and Pro Comp 76cc iron heads. These are a good choice for medium performance levels, where saving weight is more important than bottom end torque, such as lightweight drag cars and gearbox airboats, but you aren't going for maximum power. CNC porting is available, if you need more airflow, but don't have the room for the extra inch of intake height the Boogie Man heads will give you, but they will still not be in the same league for power output.

[Read More](#)

Price: \$3,599.00

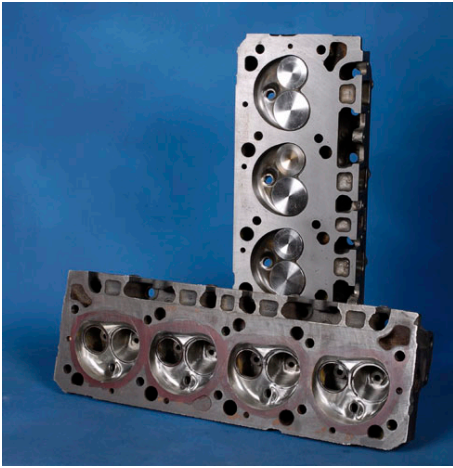

AF81420 PRO/COMP HEADS LARGE CHAMBER

SKU: AF81420

PRO/COMP HEADS

Large Chamber Heads. PRO/Comp cylinder heads also feature fully worked ports, radiused guides, 2.19" intake valves, 1.85" exhaust Chromoly spring cups, dual valve springs, lightweight Chromoly retainers, and hardened valve locks. While the standard package is capable of amazing performance, we do offer (and recommend) upgrades to this package for certain applications, such as Inconel valves for turbocharged applications (the stainless valves are not bulletproof under high exhaust temps), titanium valves and retainers for high RPM roller cam setups, etc.

CORE CHARGE INCLUDED

Fall 2021 - Stock levels change frequently, the ETA for new orders for Pro Comp iron heads is roughly 1-2 weeks if not in stock.

[Read More](#)

Price: \$3,090.00

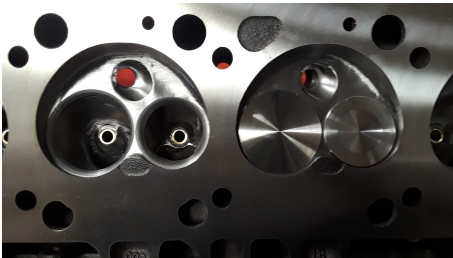

AF81410 PRO/COMP IRON HEADS SMALL CHAMBER

SKU: AF81410

Fully Ported Stainless 2.25/1.9 Valves Three angle valve job, Bronze Guides, Assembled with Dual Springs.

CORE CHARGE INCLUDED

Fall 2021 - Stock levels change frequently, the ETA for new orders for Pro Comp iron heads is roughly 1-2 weeks if not in stock.

[Read More](#)

Price: \$3,270.00

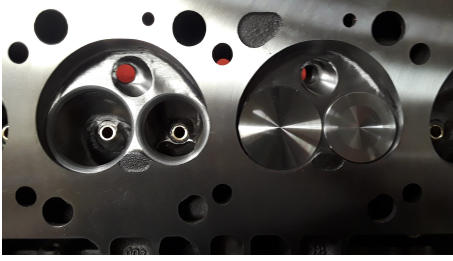

AF81400 PRO/COMP IRON HEADS

SKU: AF81400

Fully Ported Iron heads. Shot peened, magnafluxed, CBN surfaced. Bronze Guides, Stainless Valves and Competition Valve Job. Assembled with Brass Freeze Plugs and New Spring Kit

CORE CHARGE INCLUDED

Fall 2021 - Stock levels change frequently, the ETA for new orders for iron heads is roughly 1-2 weeks if not in stock.

[Read More](#)

Price: \$3,090.00 - \$3,270.00

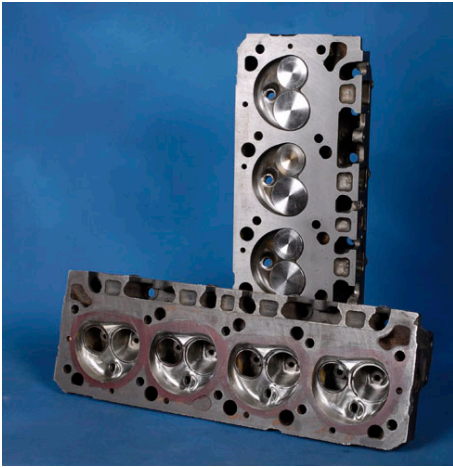

AF81320 PRO/STREET IRON HEADS LARGE CHAMBER

SKU: AF81320

PRO/STREET IRON HEADS 120CC

See 'Super Street' Heads . With more port work and reworked combustion chambers, larger 2.18/1.85 Stainless Valves these heads are the best street performance value on the market. They have no trouble supporting a real HP on pump gas, while also maximizing bottom end torque.

CORE CHARGE INCLUDED

Spring 2021 - the ETA for new orders for iron heads is roughly 2 months.

[Read More](#)

Price: \$2,490.00



AF81310 PRO STREET HEADS SMALL CHAMBER

SKU: AF81310

Cad Company Pro/Street mid-level ported heads. 76cc Small chamber castings. Ports, chambers, and bowls ported. 2.19/1.90 Stainless Steel Valves. Bronze Guides. Fully assembled with stage 2 springs and Viton seals.

The Pro/Street 120cc has 2.18/1.85 valves

Price includes a refundable \$470 core charge.

Fall 2021 - Stock levels change frequently, the ETA for new orders for iron heads is roughly 1-2 weeks if not in stock.

[Read More](#)

Price: \$2,670.00

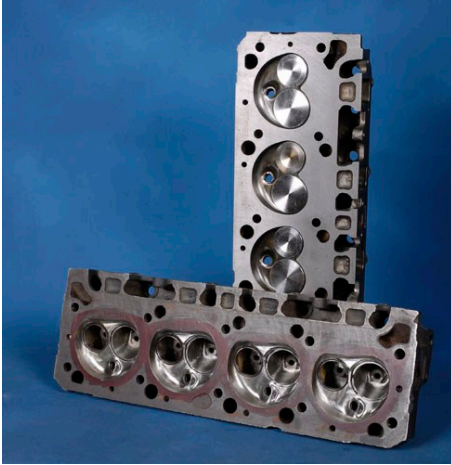

AF81300 PRO/STREET IRON HEADS

SKU: AF81300

Iron heads Ported chambers, valve pockets & port matched. Shot peened, magnafluxed, CBN surfaced. Bronze guides and Stainless valves.

Performance Valve Job & assembled with Brass freeze plugs and new spring kit

76cc has 2.19/1.9 valves

120cc has 2.18/1.85 valves

CORE CHARGE INCLUDED

Fall 2021 - Stock levels change frequently, the ETA for new orders for iron heads is roughly 1-2 weeks if not in stock.

[Read More](#)

Price: \$2,490.00 - \$2,670.00

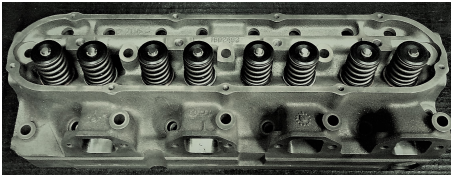

AF81220 SUPER/STREET STEEL HEADS LARGE CHAMBER

SKU: AF81220

SUPER/STREET STEEL HEADS

Large Chamber (120cc) heads. Shot-tumbled, magnafluxed, surfaced, and assembled. Intake and exhaust ports are matched to our premium gaskets. Pushrod walls on the intake side are moved back. Ports are smoothed, blended, and polished (the last 1½"). Bronze guide-liners are installed, and three angle seats are cut and hand lapped. Super/Street heads are assembled using oversize 21-4N stainless valves (2.19 / 1.85 valves), special spring shims, performance valve springs (single w/ damper), Chromoly retainers, and hardened valve locks. Valves are not "back cut" to ensure maximum longevity.

CORE CHARGE INCLUDED

Spring 2021 - the ETA for new orders for iron heads is roughly 2 months.

[Read More](#)

Price: \$2,190.00



AF81210 SUPER/STREET IRON HEADS SMALL CHAMBER

SKU: AF81210

Specify 76cc, 120cc, or 425 heads. Shot-tumbled, magnafluxed, surfaced, and assembled. Intake and exhaust ports are matched to our premium gaskets.

Cad Company Super Street ported heads. Small chamber castings. Ports, bowls, and radiuses done. 2.19/1.90 Stainless Steel Valves. Fully assembled. Price does not include core charge.

CORE CHARGE INCLUDED

Spring 2021 - the ETA for new orders for iron heads is roughly 2 months.

[Read More](#)

Price: \$2,370.00

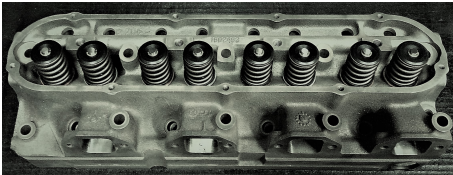

AF81130 '77-'79 425 PREMIUM RE- MANUFACTURED STOCK HEADS

SKU: AF81130

PREMIUM RE-MANUFACTURED STOCK HEADS

'77-'79 425

Shot-tumbled, magnafluxed, finely surfaced with cbn cutter, 3 angle valve job performed, bronze guide-liners and brass freeze plugs installed. No port work, assembled with stock size replacement valves (unleaded safe), Viton seals, and springs.

CORE CHARGE INCLUDED

Spring 2021 - the ETA for new orders for iron heads is roughly 2 months.

[Read More](#)

Price: \$1,240.00

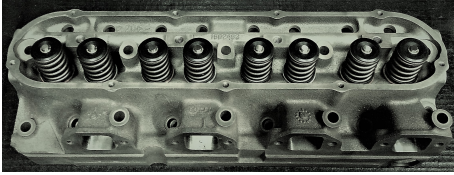

AF81120 '74-'76 472 / 500 PREMIUM RE-MANUFACTURED STOCK HEADS LARGE CHAMBER 120CC

SKU: AF81120

PREMIUM RE-MANUFACTURED STOCK HEADS

'74-'76 472 / 500 Large Chamber 120cc

Shot-tumbled, magnafluxed, finely surfaced with cbn cutter, 3 angle valve job performed, bronze guide-liners and brass freeze plugs installed. No port work, assembled with stock size replacement valves (unleaded safe), Viton seals, and springs.

CORE CHARGE INCLUDED

Spring 2021 - the ETA for new orders for iron heads is roughly 2 months.

[Read More](#)

Price: \$1,240.00

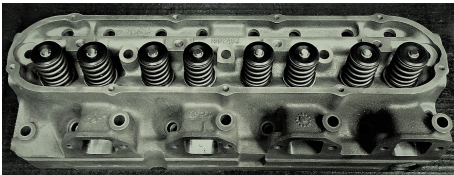

AF81110 '68-'73 472 / 500 PREMIUM RE-MANUFACTURED STOCK HEADS SMALL CHAMBER 76CC

SKU: AF81110

PREMIUM RE-MANUFACTURED STOCK HEADS

'68-'73 Small chamber 76cc

Shot-tumbled, magnafluxed, finely surfaced with cbn cutter, 3 angle valve job performed, bronze guide-liners and brass freeze plugs installed. No port work, assembled with stock size replacement valves (unleaded safe), Viton seals, and springs.

CORE CHARGE INCLUDED

Spring 2021 - the ETA for new orders for iron heads is roughly 2 months.

[Read More](#)

Price: \$1,420.00

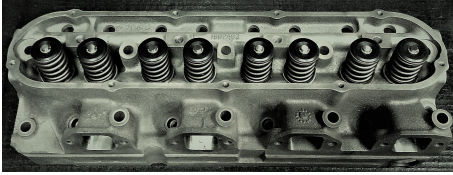

AF81100 PREMIUM RE-MANUFACTURED STOCK HEADS

SKU: AF81100

PREMIUM RE-MANUFACTURED STOCK HEADS

Shot-tumbled, magnafluxed, finely surfaced with cbn cutter, 3 angle valve job performed, bronze guide-liners and brass freeze plugs installed. No port work, assembled with stock size replacement valves (unleaded safe), Viton seals, and springs.

CORE CHARGE INCLUDED

Fall 2021 - Stock levels change frequently, the ETA for new orders for iron heads is roughly 1-2 weeks if not in stock.

[Read More](#)

Price: \$1,240.00 - \$1,420.00



AF80114 BOOGIEMAN™ HEAD STUD CONVERSION KIT

SKU: AF80114

Head Stud Conversion Kit for BoogieMan™ heads

[Read More](#)

Price: \$45.00



AF80113 BOOGIEMAN™ HEAD STUD KIT

SKU: AF80113

Head Stud Kit for BoogieMan™ heads

[Read More](#)

Price: \$255.00

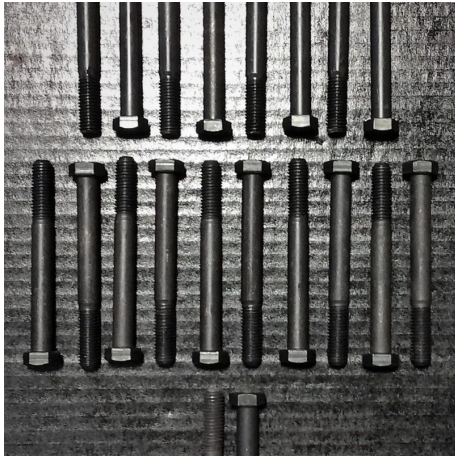

AF80101 CYLINDER HEAD BOLTS NEW (STOCK STYLE CYLINDER HEAD BOLTS)

SKU: AF80101

New stock style cylinder head bolts

[Read More](#)

Price: \$125.00



AF72215 CAD COMPANY PRO/CAD™ III

SKU: AF72215-0

PC3 Ported Aluminum Dual Plane Intake

[Read More](#)

Price: \$721.76 - \$758.86

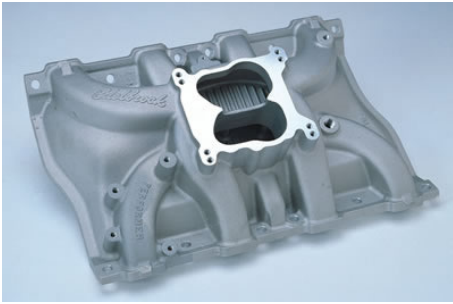

AF72115 EDELBROCK™ 2115

SKU: AF72115-0

Edelbrock™ 2115 cast hi rise dual plane intake manifold

[Read More](#)

Price: \$526.95 - \$564.05

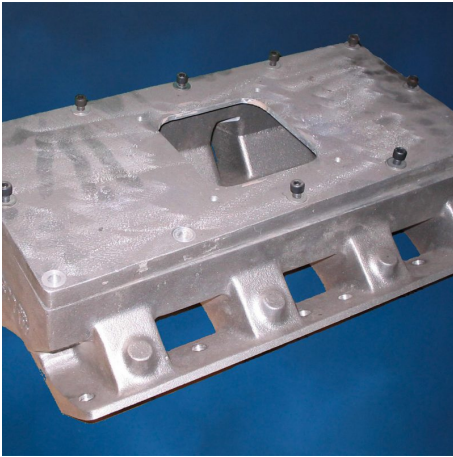

AF71480 BOOGIEMAN™ TUNNEL RAM

SKU: AF71480

The hot ticket for running multiple carbs and high RPM.

[Read More](#)

Price: \$695.00



AF71475 BOOGIEMAN™ SINGLE PLANE INTAKE

SKU: AF71475

This is the king of the hill when it comes to single carb intakes.

[Read More](#)

Price: \$695.00

HOT ROD

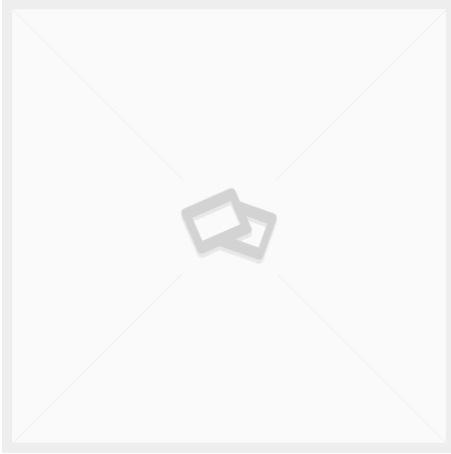

AF71105 SMALL SINGLE PLANE INTAKE STANDARD (SQUARE BORE (4150) STYLE)

SKU: AF71105

Standard square bore (4150) style

[Read More](#)

Price: \$790.00



AF70201 EGR BLOCK OFF FOR OE INTAKES, BILLET ALUMINUM

SKU: AF70201

[Read More](#)

Price: \$30.00



AF70102 FLANGE HEAD INTAKE BOLT KIT - STAINLESS STEEL

SKU: AF70102

Stainless Steel Flange Head Intake Bolt Kit

[Read More](#)

Price: \$25.00

-4%

AF65110 PROCHARGER D1SC KIT FOR 472 / 500

SKU: AF65110

PROCHARGER KIT

D1SC PROCHARGER KIT (COMPLETE) FOR CADILLAC 472 / 500

Complete kit, including pulleys, ProCharger, mounting bracket, tensioner, crank and water pump pulley, drive belt, etc. for installing a D1SC ProCharger on a 472 / 500 Cadillac engine.

[Read More](#)

Price: ~~\$7,295.00~~ \$6,995.00



AF61110 BLOWER KIT

SKU: AF61110

Blower Kit When cubic inches aren't enough

[Read More](#)

Price: \$7,500.00

-25%

AF58201 FUEL FILTER 1968 REPLACEMENT

SKU: AF58201

[Read More](#)

Price: ~~\$19.95~~ \$15.00



-6%



AF58103 FUEL FILTER 1" PAPER

SKU: AF58103

[Read More](#)

Price: ~~\$7.99~~ \$7.50

-6%



AF58102 FUEL FILTER 1976-UP 2" LONG

SKU: AF58102

[Read More](#)

Price: ~~\$7.99~~ \$7.50



AF58101 FUEL FILTER 2 1/16" FOR 1968-1975

SKU: AF58101

Paper Fuel Filter for Q-Jet carb 2 1/16" long



[Read More](#)

Price: \$7.99 \$7.50

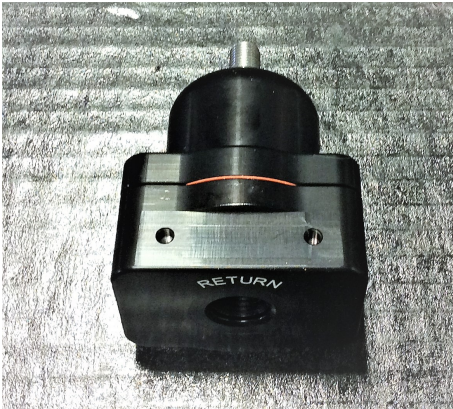

AF56302 ADJUSTABLE BYPASS STYLE FUEL PRESSURE REGULATOR (HIGH PRESSURE FUEL INJECTED)

SKU: AF56302

High Performance Adjustable Bypass Style Fuel Pressure Regulator

30-120 PSI for use with electric fuel pumps and fuel injection, with vacuum / boost reference.

Recommended for use serious high-output N/A and most boosted applications.

-10 AN inlet (1) / outlet (2). Mounting bracket included.

[Read More](#)

Price: \$350.00

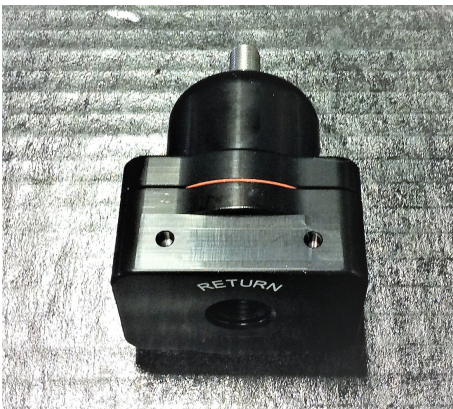

AF56301 ADJUSTABLE BYPASS STYLE FUEL PRESSURE REGULATOR (FUEL INJECTED)

SKU: AF56301

High Performance Adjustable Bypass Style Fuel Pressure Regulator

30-70 PSI for use with electric fuel pumps and fuel injection, with vacuum / boost reference.

With gauge port, -6 AN (O-Ring) inlet (2) / outlet (1). Mounting bracket included. Includes plug and hose barb fitting for gauge port.

[Read More](#)

Price: \$170.00

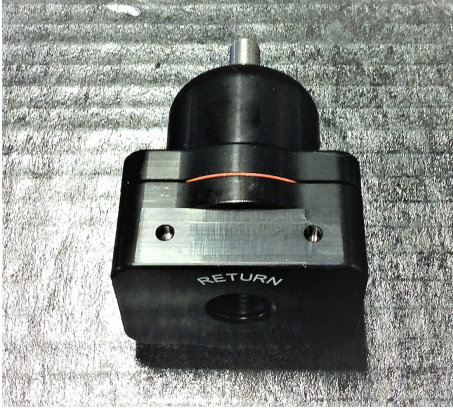

AF56201 ADJUSTABLE BYPASS STYLE FUEL PRESSURE REGULATOR (CARB OR FUEL INJECTED)

SKU: AF56201

High Performance Adjustable Bypass Style Fuel Pressure Regulator

Recommended for use with electric fuel pumps
3-60 PSI for electric pumps with carbureted or fuel injected applications, with vacuum / boost reference.
3/8" NPT inlet (1) / outlet (3). Mounting bracket included.

This is the way to go if you're buying an electric pump and regulator, and plan to go to EFI later, but want to run a carb 'for now'.

[Read More](#)

Price: \$190.00



AF56101 ADJUSTABLE BYPASS STYLE FUEL PRESSURE REGULATOR (CARB)

SKU: AF56101

Adjustable Bypass Style Fuel Pressure Regulator

3-12 PSI for use with mechanical or electric fuel pumps in carbureted applications

3/8 NPT 1x inlet / 1x outlet

[Read More](#)

Price: \$150.00

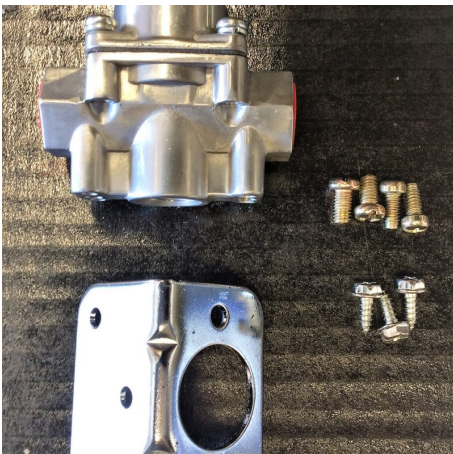

AF56010 ADJUSTABLE FUEL PRESSURE REGULATOR (CARB)

SKU: AF56010

Adjustable Fuel Pressure Regulator

Recommended for use with any mechanical pump needing a regulator, on carbureted applications.

W/ dual outlets for double pumpers or for running a pressure gauge
Satin finish.

[Read More](#)

Price: \$55.00



AF53111 BILLET ALUMINUM FUEL PUMP BLOCK OFF

SKU: AF53111

Billet Aluminum Fuel Pump Block Off

[Read More](#)

Price: \$39.00

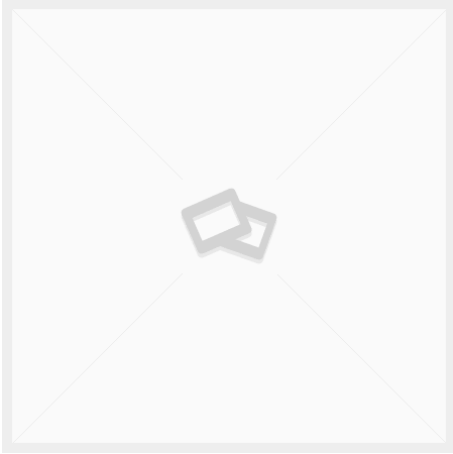

AF53021 IN-TANK PUMP & BAFFLE RETROFIT KIT

SKU: AF53021

Baffled in-tank fuel pump kit for reliable, drivable EFI retrofits with non-EFI OE fuel tanks. No welding required for installation. For 6"-12" deep tanks. 340 lph free-flow.

-6 AN fittings, 90 GPM, supports 800+HP NA
Fits 6"-12" deep tanks, must cut 3.25" hole.

[Read More](#)

Price: \$675.00



AF51250 RACING MECHANICAL FUEL PUMP

SKU: AF51250

Racing Mechanical Fuel Pump

Supports up to 1100 HP, Made in USA

[Read More](#)

Price: \$375.00





AF51230 HIGH PERFORMANCE MECHANICAL FUEL PUMP

SKU: AF51230

High Performance Mechanical Fuel Pump

Supports up to 550 HP, Made in USA

[Read More](#)

Price: \$255.00



AF51210 CHROME MECHANICAL FUEL PUMP

SKU: AF51210

Chrome Mechanical Fuel Pump

[Read More](#)

Price: \$175.00

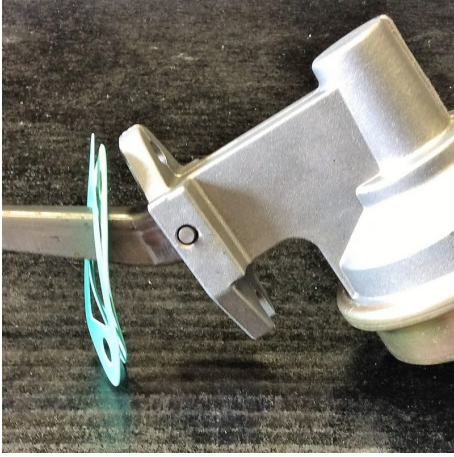

AF51110 OE REPLACEMENT FUEL PUMP

SKU: AF51110

OE Replacement Pump
w/ or w/o return line fitting

[Read More](#)

Price: \$95.00



AF51003 USED FUEL PUMP ECCENTRIC

SKU: AF51003

Billet Steel Fuel Pump Eccentric

[Read More](#)

Price: \$25.00

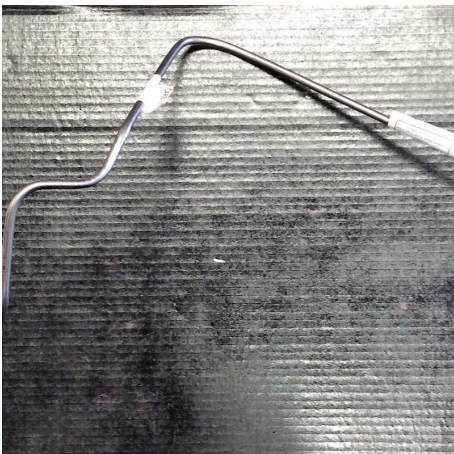

AF40013 STAINLESS STEEL FUEL LINE 3/8"

SKU: AF40013

Pre-bent for OE '73-'76 fuel pump and OE '73-'79 Cadillac Q-jet on OE intake. Made in USA

[Read More](#)

Price: \$60.00

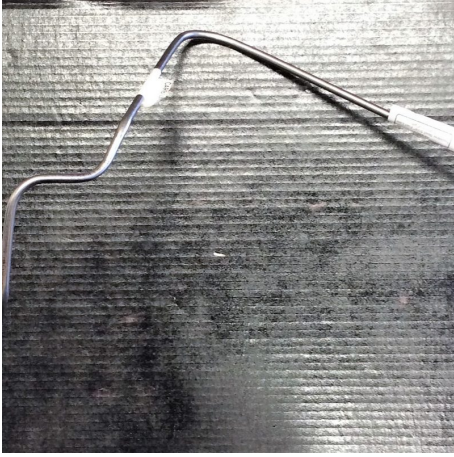

AF40012 STEEL FUEL LINE 3/8"

SKU: AF40012

Pre-bent for OE '73-'76 fuel pump and OE '73-'79 Cadillac Q-jet on OE intake. Made in USA

[Read More](#)

Price: \$45.00

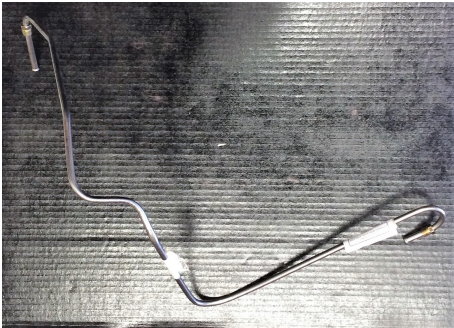

AF40011 STAINLESS STEEL FUEL LINE 5/16"

SKU: AF40011

Pre-bent for OE '72-older fuel pump w/ return line outlet on pump and OE '68-'72 Cadillac Q-jet on OE intake. Made in USA

[Read More](#)

Price: \$60.00

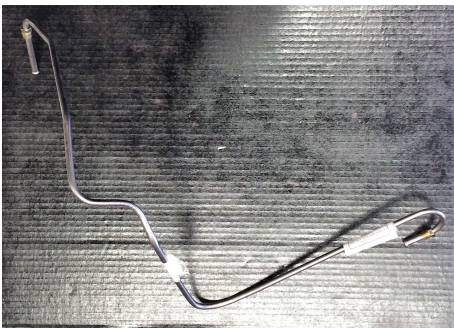

AF40010 STEEL FUEL LINE 5/16"

SKU: AF40010

Pre-bent for OE '72-older fuel pump w/ return line outlet on pump and OE '68-'72 Cadillac Q-jet on OE intake. Made in USA

[Read More](#)

Price: \$45.00

AF28020 Q-JET TUNING KIT

SKU: AF28020

[Read More](#)

Price: \$65.00



AF12520 STREET DEMON 750 CFM

SKU: AF12520

Well suited for higher powered street and circle track / road racing applications for 331, 365, 390, and 429 CID engines with square bore or 4-jet (pre-'67) style intake manifolds.

[Read More](#)

Price: \$445.95

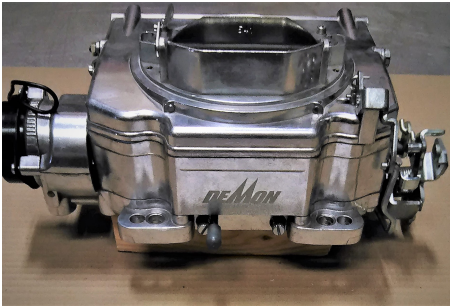

AF12510 STREET DEMON 625 CFM

SKU: AF12510

Well suited for street applications for 331, 365, 390, and 429 CID engines with square bore or 4-jet (pre-'67) style intake manifolds.

[Read More](#)

Price: \$403.75

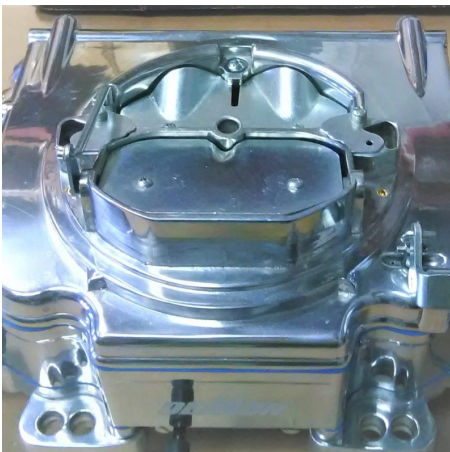



AF12210 Q-JET CARBURETOR - 795 CFM WITH CHEVY LINKAGE AND ELECTRIC CHOKE

SKU: AF12210

Q-Jet Carburetor - 795 CFM with Chevy Linkage, Electric Choke,



and 3/8" Fuel Inlet

Please verify manifold, linkage, and choke compatibility before ordering.

\$200 core charge included in price.

[Read More](#)

Price: \$635.00

AF12112 Q-JET CARBURETOR - '73-'74 SPEC 795 CFM WITH CADILLAC LINKAGE AND DIVORCED CHOKE

SKU: AF12112

Q-Jet Carburetor - '73-'74 Spec 795 CFM with Cadillac Linkage,



Divorced Choke, and 3/8" Fuel Inlet

Please verify manifold, linkage, and choke compatibility before ordering.

\$200 core charge included in price.

[Read More](#)

Price: \$635.00





AF12111 Q-JET CARBURETOR - '69 SPEC 750 CFM WITH CADILLAC LINKAGE AND DIVORCED CHOKE

SKU: AF12111

Q-Jet Carburetor - '69 Spec 750 CFM with Cadillac Linkage,



Divorced Choke, and 5/16" Fuel Inlet

Please verify manifold, linkage, and choke compatibility before ordering.

\$200 core charge included in price.

[Read More](#)

Price: \$635.00



AF12010 Q-JET CARBURETOR - 795 CFM WITH CADILLAC LINKAGE AND ELECTRIC CHOKE

SKU: AF12010

Q-Jet Carburetor - 795 CFM with Cadillac Linkage, Electric Choke,



and 3/8" Fuel Inlet

Please verify manifold, linkage, and choke compatibility before ordering.

\$350 core charge included in price.

[Read More](#)

Price: \$785.00

AIR CLEANERS



AF96225 SPUN ALUMINUM AIR CLEANER KIT - TALL

SKU: AF96201

Tall Spun Aluminum Air Cleaner Kit

Includes spun aluminum base, top, 5" air filter element, and stud kit.

This air cleaner kit sits down deep over the carb and has a 5" tall filter for maximum airflow and a killer look. Clears Q-jets great, but will not clear most aftermarket carbs without a carb-to-air-cleaner spacer.

Hand spun base and lid looks and flows great.

[Read More](#)

Price: \$90.00



AF96225 SPUN ALUMINUM AIR CLEANER KIT - SHORT

SKU: AF96225

Short Spun Aluminum Air Cleaner Kit

Includes spun aluminum base, top, 2.5" air filter element, and stud kit.

This air cleaner kit sits down deep over the carb and gives you maximum hood clearance with a standard 14" round air filter. Clears Q-jets great, but will not clear most aftermarket carbs.

Hand spun base and lid looks and flows great.

[Read More](#)

Price: \$80.00





AF96104 CHROME AIR CLEANER KIT

SKU: AF96104

flat base with riser, includes filter

[Read More](#)

Price: \$65.00



AF96102 CHROME AIR CLEANER KIT (DROP BASE)

SKU: AF96102

drop base, includes filter

[Read More](#)

Price: \$45.00



AF96101 CHROME AIR CLEANER KIT

SKU: AF96101

flat base, includes filter

[Read More](#)

Price: \$30.00



AF93425 K&N 2 1/2" AIR FILTER

SKU: AF93425

Recommended for most aftermarket 14" air cleaner assemblies

[Read More](#)

Price: \$90.00



AF93401 K&N AIR FILTER

SKU: AF93401

K&N Air Filter For stock air cleaner assemblies

[Read More](#)

Price: \$95.00



AF93250 MOROSO 5" AIR FILTER

SKU: AF93250

Recommended for our spun aluminum deep dish air cleaner assembly

[Read More](#)

Price: \$50.00



AF92010 SPUN ALUMINUM AIR CLEANER TOP WITH INTEGRAL AIR DEFLECTION CONE

SKU: AF92010

Fits most 14" air cleaners

[Read More](#)

Price: ~~\$35.00~~ \$30.00

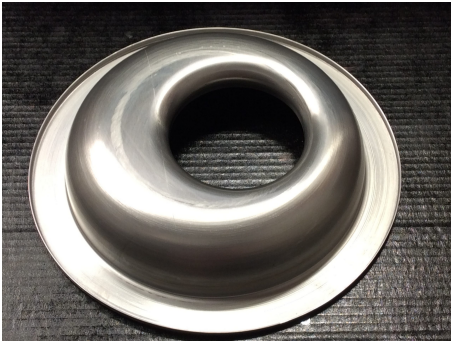

AF91011 SPUN ALUMINUM AIR CLEANER DROP BASE, OFFSET MOUNT

SKU: AF91011

Spun Aluminum Air Cleaner Drop Base, Offset mount

[Read More](#)

Price: \$35.00



AF91010 AIR FILTER DROPPED BASE 14"

SKU: AF91010

[Read More](#)

Price: ~~\$39.95~~ \$35.00



AF90020 AIR CLEANER STUD KIT, UNIVERSAL

SKU: AF90020

Not for offset air cleaners

[Read More](#)

Price: \$10.00

BLOWER KIT

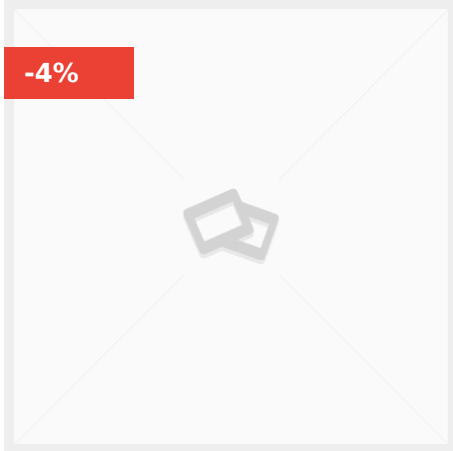

AF65110 PROCHARGER D1SC KIT FOR 472 / 500

SKU: AF65110

PROCHARGER KIT

D1SC PROCHARGER KIT (COMPLETE) FOR CADILLAC 472 / 500

Complete kit, including pulleys, ProCharger, mounting bracket, tensioner, crank and water pump pulley, drive belt, etc. for installing a D1SC ProCharger on a 472 / 500 Cadillac engine.

[Read More](#)

Price: ~~\$7,295.00~~ \$6,995.00



AF61110 BLOWER KIT

SKU: AF61110

Blower Kit When cubic inches aren't enough

[Read More](#)

Price: \$7,500.00

CARBURETORS



GS10213 CARB GASKET, 1/4" THICK '70-'84

SKU: GS10213

Carb Gasket '70-'84 Q-jet w/o exhaust at carb base

1/4" thick insulator style.

[Read More](#)

Price: \$8.00

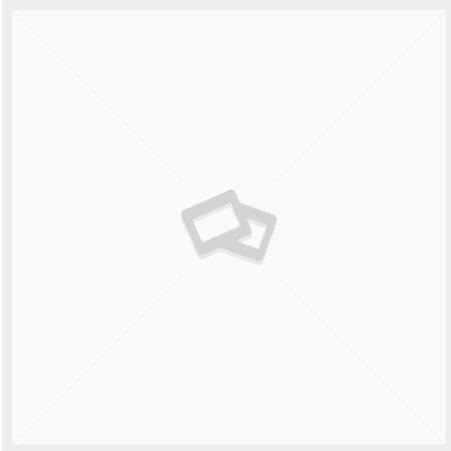

GS10212 CARB GASKET '70-'84

SKU: GS10212

Carb Gasket '70-'84

[Read More](#)

Price: \$8.00

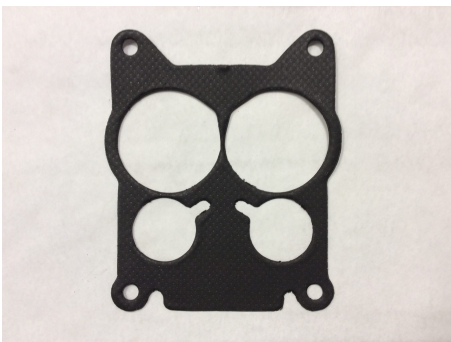

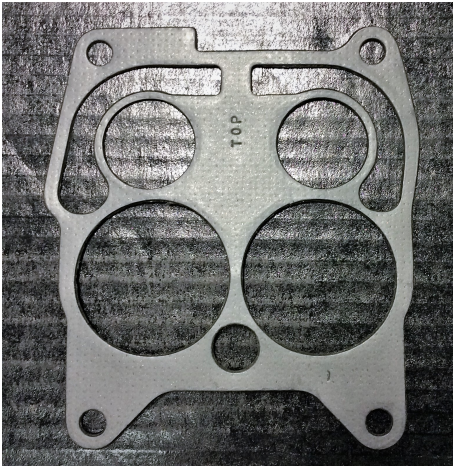

GS10211 CARB GASKET '67-'70

SKU: GS10211

Carb Gasket '67-'70

[Read More](#)

Price: \$8.00



AF58201 FUEL FILTER 1968 REPLACEMENT

SKU: AF58201

[Read More](#)

Price: ~~\$19.95~~ \$15.00



AF58103 FUEL FILTER 1" PAPER

SKU: AF58103

[Read More](#)

Price: ~~\$7.99~~ \$7.50

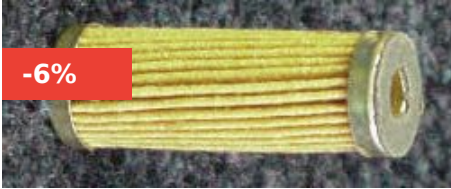

AF58101 FUEL FILTER 2 1/16" FOR 1968-1975

SKU: AF58101

Paper Fuel Filter for Q-Jet carb 2 1/16" long



[Read More](#)

Price: \$7.99 ~~\$7.50~~



AF28020 Q-JET TUNING KIT

SKU: AF28020

[Read More](#)

Price: \$65.00

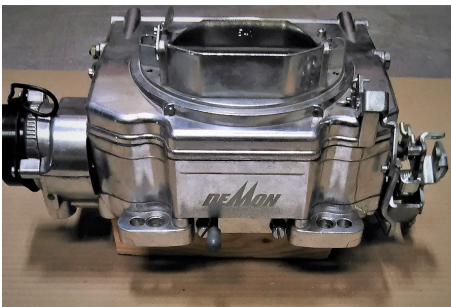

AF12520 STREET DEMON 750 CFM

SKU: AF12520

Well suited for higher powered street and circle track / road racing applications for 331, 365, 390, and 429 CID engines with square bore or 4-jet (pre-'67) style intake manifolds.

[Read More](#)

Price: \$445.95

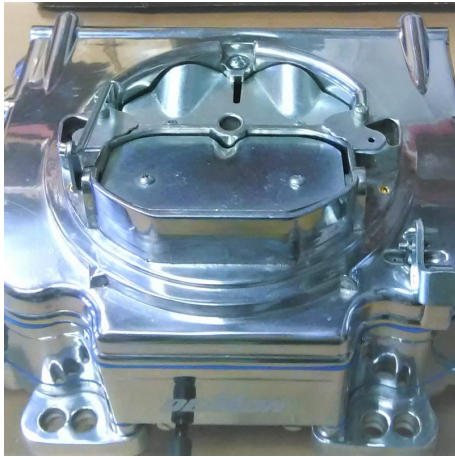

AF12510 STREET DEMON 625 CFM

SKU: AF12510

Well suited for street applications for 331, 365, 390, and 429 CID engines with square bore or 4-jet (pre-'67) style intake manifolds.

[Read More](#)

Price: \$403.75



AF12210 Q-JET CARBURETOR - 795 CFM WITH CHEVY LINKAGE AND ELECTRIC CHOKE

SKU: AF12210

Q-Jet Carburetor - 795 CFM with Chevy Linkage, Electric Choke,



**MADE IN
THE U.S.A.**

and 3/8" Fuel Inlet

Please verify manifold, linkage, and choke compatibility before ordering.

\$200 core charge included in price.

[Read More](#)

Price: \$635.00



AF12112 Q-JET CARBURETOR - '73-'74 SPEC 795 CFM WITH CADILLAC LINKAGE AND DIVORCED CHOKE

SKU: AF12112

Q-Jet Carburetor - '73-'74 Spec 795 CFM with Cadillac Linkage,



**MADE IN
THE U.S.A.**

Divorced Choke, and 3/8" Fuel Inlet

Please verify manifold, linkage, and choke compatibility before ordering.

\$200 core charge included in price.

[Read More](#)



Price: \$635.00

AF12111 Q-JET CARBURETOR - '69 SPEC 750 CFM WITH CADILLAC LINKAGE AND DIVORCED CHOKE

SKU: AF12111

Q-Jet Carburetor - '69 Spec 750 CFM with Cadillac Linkage,



**MADE IN
THE U.S.A.**

Divorced Choke, and 5/16" Fuel Inlet

Please verify manifold, linkage, and choke compatibility before ordering.

\$200 core charge included in price.

[Read More](#)

Price: \$635.00



AF12010 Q-JET CARBURETOR - 795 CFM WITH CADILLAC LINKAGE AND ELECTRIC CHOKE

SKU: AF12010

Q-Jet Carburetor - 795 CFM with Cadillac Linkage, Electric Choke,



**MADE IN
THE U.S.A.**

and 3/8" Fuel Inlet

Please verify manifold, linkage, and choke compatibility before ordering.

\$350 core charge included in price.

[Read More](#)

Price: \$785.00

CYLINDER HEADS

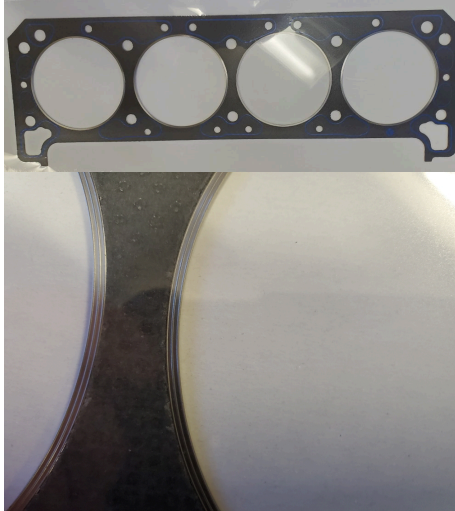

GS511056 CUT RING HEAD GASKET FOR 472 / 500

SKU: GS51105.6

472 / 500 Cadillac Cut Ring Head Gasket

Cut ring head gasket for bore sizes up to 4.360" (.060" over) or 4.420" (.120" over). Choose a size when ordering.

These are the best sealing available for high cylinder pressure applications.

[Read More](#)

Price: \$175.00

BH15013 FREEZE PLUG KIT FOR 425 HEADS

SKU: N/A

Freeze Plug Kit for 425 Heads

Kit includes 4 disc type plugs and 2 cup type plugs (does not include water outlet).

1 Kit per engine

[Read More](#)

Price: \$5.00 - \$20.00



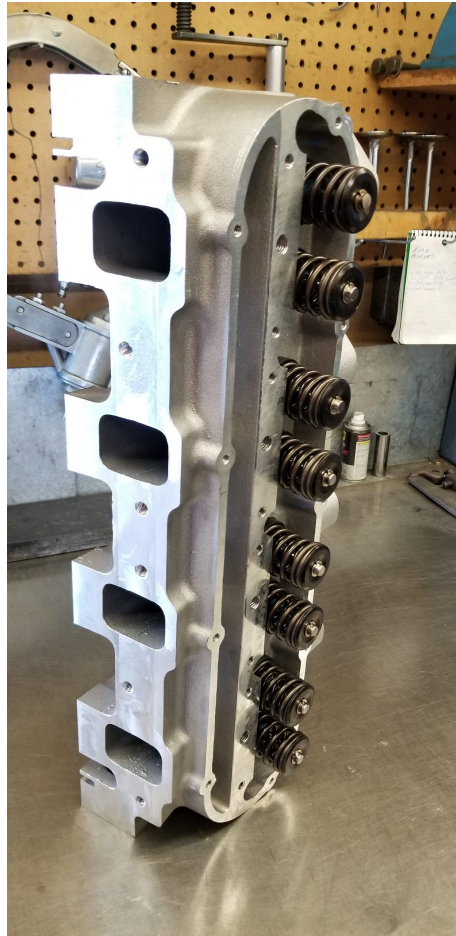

AF85400 BOOGIEMAN™ ALUMINUM HEADS

SKU: AF85400

The world famous "BoogieMan" cylinder heads are in stock and ready to ship. This is the next step in the "Boogie-Man" line. Using an American made casting, CNC machining, and a top-of-the-line seat and guide machine, we have the absolute best cylinder head for a high performance 472 or 500 Cadillac, on the market today. They have 70cc combustion chamber chambers (adds about 1/2 a point of CR over 76cc iron heads), and include 2.25" / 1.8" valves (the same high-grade stainless steel and production methods used for our iron head valves). These heads have been used on numerous applications from daily drivers to full race applications, and they weigh in at 32 Lbs. (vs. the stock iron head's average weight of 62 Lbs.) per head.

[Read More](#)

Price: \$3,600.00



AF85141 FACTORY REPLACEMENT ALUMINUM HEADS

SKU: AF85141

These are the evolved version of the old Bulldog aluminum heads. They have 76cc combustion chambers and include 2.19 / 1.90 stainless valves, and weigh in at 38 Lbs. per head, vs 62 Lbs. per head for your average iron head.

Performance wise, they fall in between our Pro Street and Pro Comp 76cc iron heads. These are a good choice for medium performance levels, where saving weight is more important than bottom end torque, such as lightweight drag cars and gearbox airboats, but you aren't going for maximum power. CNC porting is available, if you need more airflow, but don't have the room for the extra inch of intake height the Boogie Man heads will give you, but they will still not be in the same league for power output.

[Read More](#)

Price: \$3,599.00

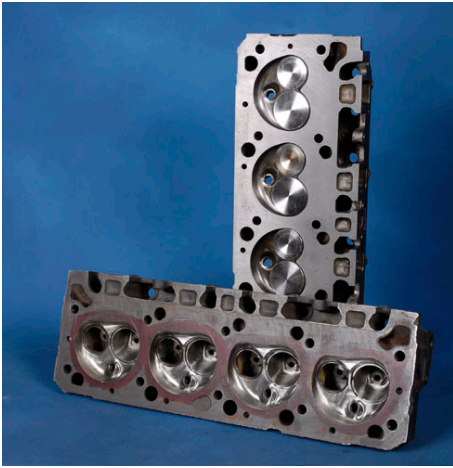

AF81420 PRO/COMP HEADS LARGE CHAMBER

SKU: AF81420

PRO/COMP HEADS

Large Chamber Heads. PRO/Comp cylinder heads also feature fully worked ports, radiused guides, 2.19" intake valves, 1.85" exhaust Chromoly spring cups, dual valve springs, lightweight Chromoly retainers, and hardened valve locks. While the standard package is capable of amazing performance, we do offer (and recommend) upgrades to this package for certain applications, such as Inconel valves for turbocharged applications (the stainless valves are not bulletproof under high exhaust temps), titanium valves and retainers for high RPM roller cam setups, etc.

CORE CHARGE INCLUDED

Fall 2021 - Stock levels change frequently, the ETA for new orders for Pro Comp iron heads is roughly 1-2 weeks if not in stock.

[Read More](#)

Price: \$3,090.00

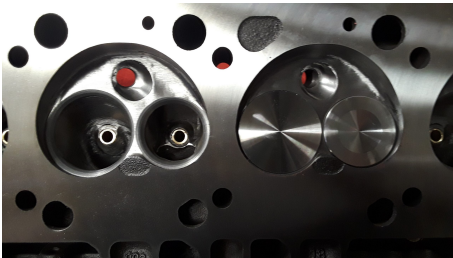

AF81410 PRO/COMP IRON HEADS SMALL CHAMBER

SKU: AF81410

Fully Ported Stainless 2.25/1.9 Valves Three angle valve job, Bronze Guides, Assembled with Dual Springs.

CORE CHARGE INCLUDED

Fall 2021 - Stock levels change frequently, the ETA for new orders for Pro Comp iron heads is roughly 1-2 weeks if not in stock.

[Read More](#)

Price: \$3,270.00

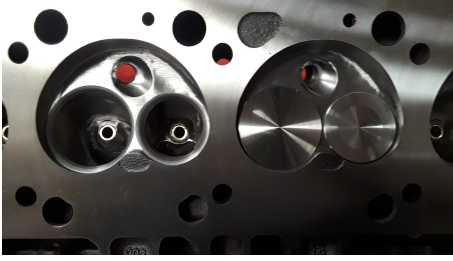

AF81400 PRO/COMP IRON HEADS

SKU: AF81400

Fully Ported Iron heads. Shot peened, magnafluxed, CBN surfaced. Bronze Guides, Stainless Valves and Competition Valve Job. Assembled with Brass Freeze Plugs and New Spring Kit

CORE CHARGE INCLUDED

Fall 2021 - Stock levels change frequently, the ETA for new orders for iron heads is roughly 1-2 weeks if not in stock.

[Read More](#)

Price: \$3,090.00 - \$3,270.00



AF81320 PRO/STREET IRON HEADS LARGE CHAMBER

SKU: AF81320

PRO/STREET IRON HEADS 120CC

See 'Super Street' Heads . With more port work and reworked combustion chambers, larger 2.18/1.85 Stainless Valves these heads are the best street performance value on the market. They have no trouble supporting a real HP on pump gas, while also maximizing bottom end torque.

CORE CHARGE INCLUDED

Spring 2021 - the ETA for new orders for iron heads is roughly 2 months.

[Read More](#)

Price: \$2,490.00

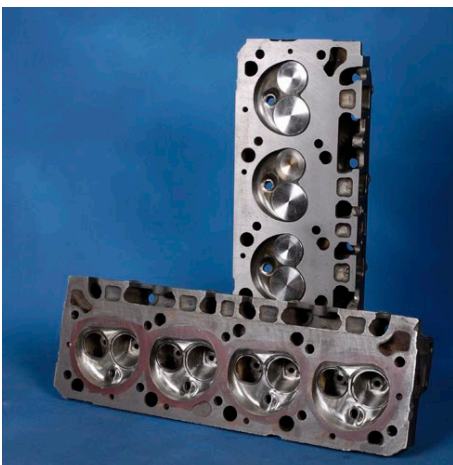

AF81310 PRO STREET HEADS SMALL CHAMBER

SKU: AF81310

Cad Company Pro/Street mid-level ported heads. 76cc Small chamber castings. Ports, chambers, and bowls ported. 2.19/1.90 Stainless Steel Valves. Bronze Guides. Fully assembled with stage 2 springs and Viton seals.

The Pro/Street 120cc has 2.18/1.85 valves

Price includes a refundable \$470 core charge.

Fall 2021 - Stock levels change frequently, the ETA for new orders for iron heads is roughly 1-2 weeks if not in stock.

[Read More](#)

Price: \$2,670.00

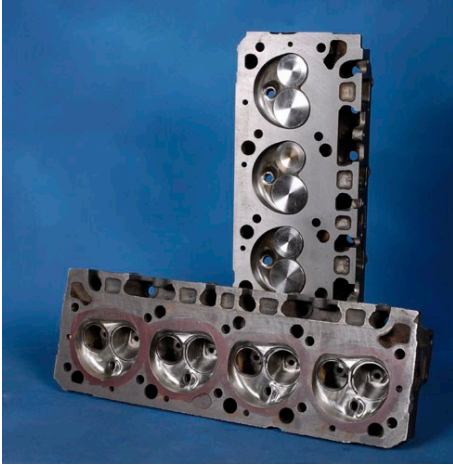

AF81300 PRO/STREET IRON HEADS

SKU: AF81300

Iron heads Ported chambers, valve pockets & port matched. Shot peened, magnafluxed, CBN surfaced . Bronze guides and Stainless valves.

Performance Valve Job & assembled with Brass freeze plugs and new spring kit

76cc has 2.19/1.9 valves

120cc has 2.18/1.85 valves

CORE CHARGE INCLUDED

Fall 2021 - Stock levels change frequently, the ETA for new orders for iron heads is roughly 1-2 weeks if not in stock.

[Read More](#)

Price: \$2,490.00 - \$2,670.00

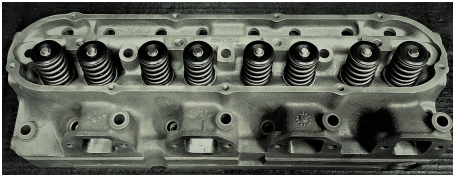

AF81220 SUPER/STREET STEEL HEADS LARGE CHAMBER

SKU: AF81220

SUPER/STREET STEEL HEADS

Large Chamber (120cc) heads. Shot-tumbled, magnafluxed, surfaced, and assembled. Intake and exhaust ports are matched to our premium gaskets. Pushrod walls on the intake side are moved back. Ports are smoothed, blended, and polished (the last 1½"). Bronze guide-liners are installed, and three angle seats are cut and hand lapped. Super/Street heads are assembled using oversize 21-4N stainless valves (2.19 / 1.85 valves), special spring shims, performance valve springs (single w/ damper), Chromoly retainers, and hardened valve locks. Valves are not "back cut" to ensure maximum longevity.

CORE CHARGE INCLUDED

Spring 2021 - the ETA for new orders for iron heads is roughly 2 months.

[Read More](#)

Price: \$2,190.00



AF81210 SUPER/STREET IRON HEADS SMALL CHAMBER

SKU: AF81210

Specify 76cc, 120cc, or 425 heads. Shot-tumbled, magnafluxed, surfaced, and assembled. Intake and exhaust ports are matched to our premium gaskets.

Cad Company Super Street ported heads. Small chamber castings. Ports, bowls, and radiuses done. 2.19/1.90 Stainless Steel Valves. Fully assembled. Price does not include core charge.

CORE CHARGE INCLUDED

Spring 2021 - the ETA for new orders for iron heads is roughly 2 months.

[Read More](#)

Price: \$2,370.00

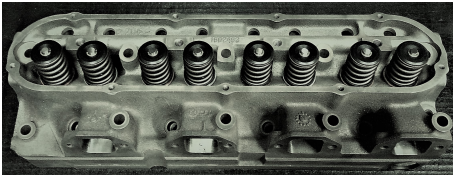

AF81130 '77-'79 425 PREMIUM RE- MANUFACTURED STOCK HEADS

SKU: AF81130

PREMIUM RE-MANUFACTURED STOCK HEADS

'77-'79 425

Shot-tumbled, magnafluxed, finely surfaced with cbn cutter, 3 angle valve job performed, bronze guide-liners and brass freeze plugs installed. No port work, assembled with stock size replacement valves (unleaded safe), Viton seals, and springs.

CORE CHARGE INCLUDED

Spring 2021 - the ETA for new orders for iron heads is roughly 2 months.

[Read More](#)

Price: \$1,240.00

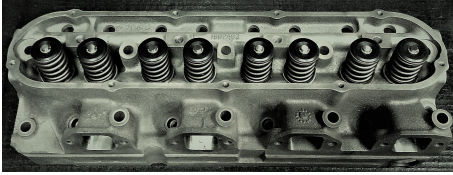

AF81120 '74-'76 472 / 500 PREMIUM RE-MANUFACTURED STOCK HEADS LARGE CHAMBER 120CC

SKU: AF81120

PREMIUM RE-MANUFACTURED STOCK HEADS

'74-'76 472 / 500 Large Chamber 120cc

Shot-tumbled, magnafluxed, finely surfaced with cbn cutter, 3 angle valve job performed, bronze guide-liners and brass freeze plugs installed. No port work, assembled with stock size replacement valves (unleaded safe), Viton seals, and springs.

CORE CHARGE INCLUDED

Spring 2021 - the ETA for new orders for iron heads is roughly 2 months.

[Read More](#)

Price: \$1,240.00

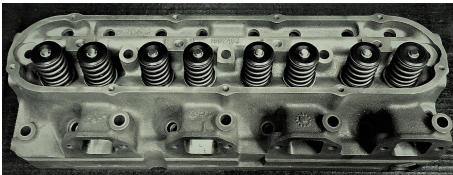

AF81110 '68-'73 472 / 500 PREMIUM RE-MANUFACTURED STOCK HEADS SMALL CHAMBER 76CC

SKU: AF81110

PREMIUM RE-MANUFACTURED STOCK HEADS

'68-'73 Small chamber 76cc

Shot-tumbled, magnafluxed, finely surfaced with cbn cutter, 3 angle valve job performed, bronze guide-liners and brass freeze plugs installed. No port work, assembled with stock size replacement valves (unleaded safe), Viton seals, and springs.

CORE CHARGE INCLUDED

Spring 2021 - the ETA for new orders for iron heads is roughly 2 months.

[Read More](#)

Price: \$1,420.00

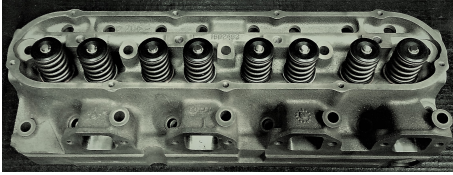

AF81100 PREMIUM RE-MANUFACTURED STOCK HEADS

SKU: AF81100

PREMIUM RE-MANUFACTURED STOCK HEADS

Shot-tumbled, magnafluxed, finely surfaced with cbn cutter, 3 angle valve job performed, bronze guide-liners and brass freeze plugs installed. No port work, assembled with stock size replacement valves (unleaded safe), Viton seals, and springs.

CORE CHARGE INCLUDED

Fall 2021 - Stock levels change frequently, the ETA for new orders for iron heads is roughly 1-2 weeks if not in stock.

[Read More](#)

Price: \$1,240.00 - \$1,420.00



AF80114 BOOGIEMAN™ HEAD STUD CONVERSION KIT

SKU: AF80114

Head Stud Conversion Kit for BoogieMan™ heads

[Read More](#)

Price: \$45.00



AF80113 BOOGIEMAN™ HEAD STUD KIT

SKU: AF80113

Head Stud Kit for BoogieMan™ heads

[Read More](#)

Price: \$255.00

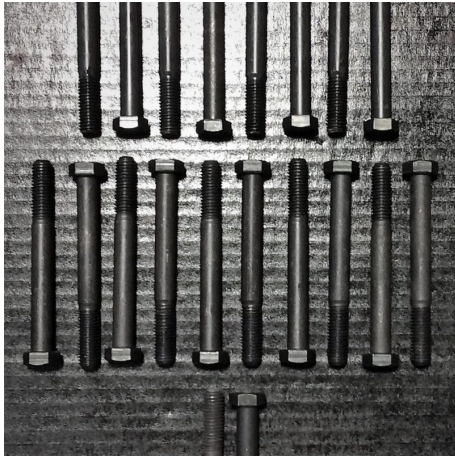

AF80101 CYLINDER HEAD BOLTS NEW (STOCK STYLE CYLINDER HEAD BOLTS)

SKU: AF80101

New stock style cylinder head bolts

[Read More](#)

Price: \$125.00

CYLINDER HEAD FASTENERS PARTS, AND KITS

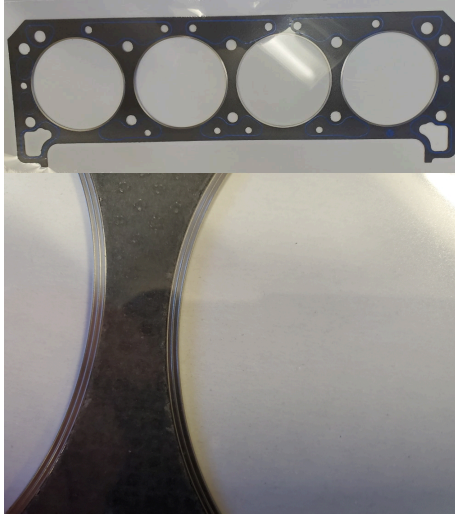

GS511056 CUT RING HEAD GASKET FOR 472 / 500

SKU: GS51105.6

472 / 500 Cadillac Cut Ring Head Gasket

Cut ring head gasket for bore sizes up to 4.360" (.060" over) or 4.420" (.120" over). Choose a size when ordering.

These are the best sealing available for high cylinder pressure applications.

[Read More](#)

Price: \$175.00

BH15013 FREEZE PLUG KIT FOR 425 HEADS

SKU: N/A

Freeze Plug Kit for 425 Heads

Kit includes 4 disc type plugs and 2 cup type plugs (does not include water outlet).

1 Kit per engine

[Read More](#)

Price: \$5.00 - \$20.00





AF80114 BOOGIEMAN™ HEAD STUD CONVERSION KIT

SKU: AF80114

Head Stud Conversion Kit for BoogieMan™ heads

[Read More](#)

Price: \$45.00



AF80113 BOOGIEMAN™ HEAD STUD KIT

SKU: AF80113

Head Stud Kit for BoogieMan™ heads

[Read More](#)

Price: \$255.00

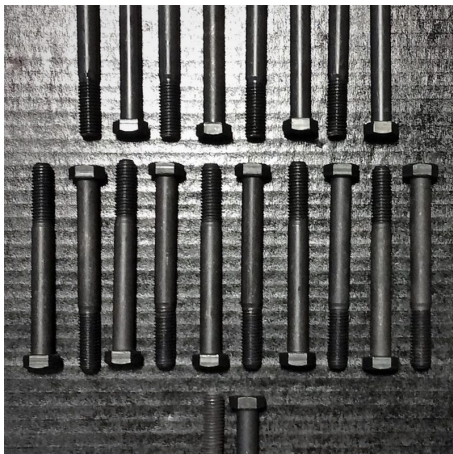

AF80101 CYLINDER HEAD BOLTS NEW (STOCK STYLE CYLINDER HEAD BOLTS)

SKU: AF80101

New stock style cylinder head bolts

[Read More](#)

Price: \$125.00

EFI FUEL INJECTION



AF53021 IN-TANK PUMP & BAFFLE RETROFIT KIT

SKU: AF53021

Baffled in-tank fuel pump kit for reliable, drivable EFI retrofits with non-EFI OE fuel tanks. No welding required for installation. For 6"-12" deep tanks. 340 lph free-flow.

-6 AN fittings, 90 GPM, supports 800+HP NA
Fits 6"-12" deep tanks, must cut 3.25" hole.

[Read More](#)

Price: \$675.00

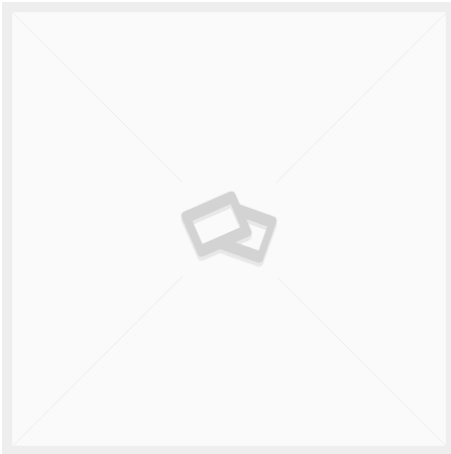

FUEL LINES

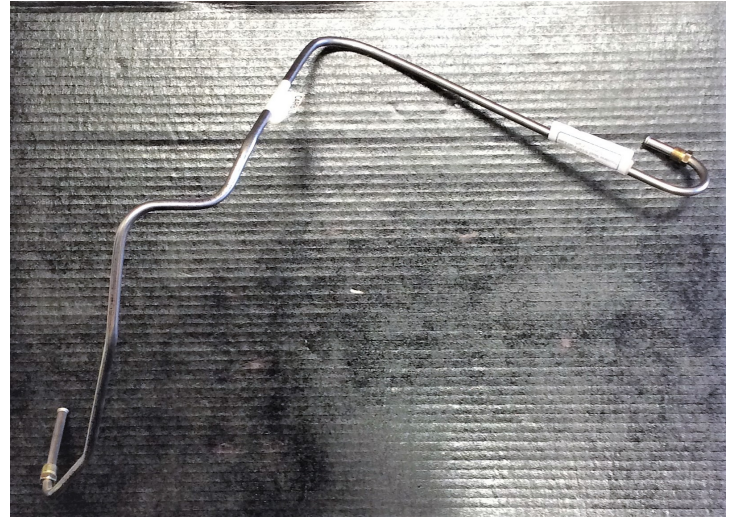

-25%



AF58201 FUEL FILTER 1968 REPLACEMENT

SKU: AF58201

[Read More](#)

Price: ~~\$19.95~~ \$15.00

-6%



AF58103 FUEL FILTER 1" PAPER

SKU: AF58103

[Read More](#)

Price: ~~\$7.99~~ \$7.50

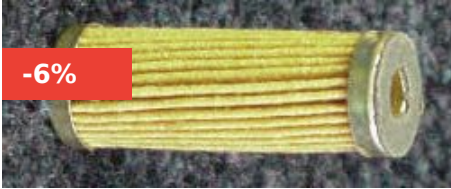

AF58102 FUEL FILTER 1976-UP 2" LONG

SKU: AF58102

[Read More](#)

Price: ~~\$7.99~~ \$7.50



AF58101 FUEL FILTER 2 1/16" FOR 1968-1975

SKU: AF58101

Paper Fuel Filter for Q-Jet carb 2 1/16" long



[Read More](#)

Price: ~~\$7.99~~ \$7.50

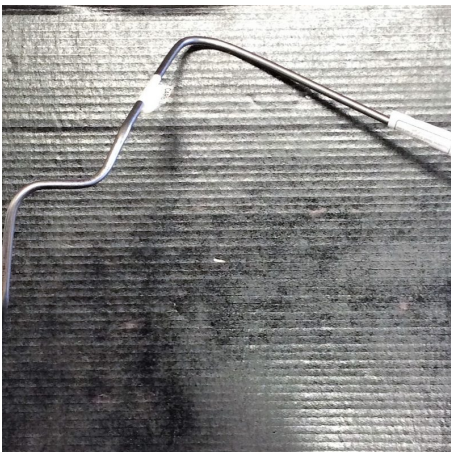

AF40013 STAINLESS STEEL FUEL LINE 3/8"

SKU: AF40013

Pre-bent for OE '73-'76 fuel pump and OE '73-'79 Cadillac Q-jet on OE intake. Made in USA

[Read More](#)

Price: \$60.00

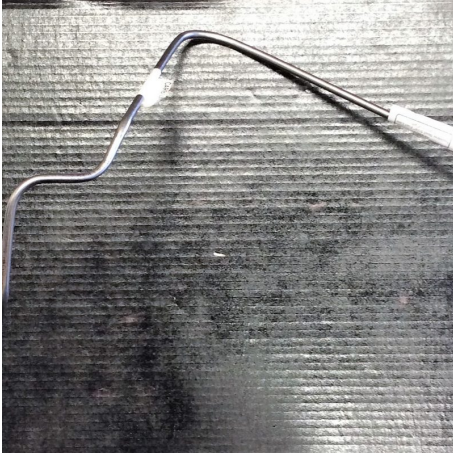

AF40012 STEEL FUEL LINE 3/8"

SKU: AF40012

Pre-bent for OE '73-'76 fuel pump and OE '73-'79 Cadillac Q-jet on OE intake. Made in USA

[Read More](#)

Price: \$45.00

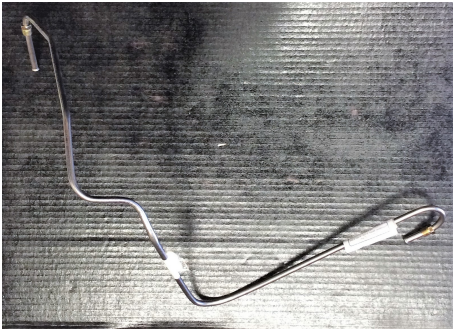

AF40011 STAINLESS STEEL FUEL LINE 5/16"

SKU: AF40011

Pre-bent for OE '72-older fuel pump w/ return line outlet on pump and OE '68-'72 Cadillac Q-jet on OE intake. Made in USA

[Read More](#)

Price: \$60.00



AF40010 STEEL FUEL LINE 5/16"

SKU: AF40010

Pre-bent for OE '72-older fuel pump w/ return line outlet on pump and OE '68-'72 Cadillac Q-jet on OE intake. Made in USA

[Read More](#)

Price: \$45.00

FUEL PUMPS



-25%



AF58201 FUEL FILTER 1968 REPLACEMENT

SKU: AF58201

[Read More](#)

Price: ~~\$19.95~~ \$15.00

-6%



AF58103 FUEL FILTER 1" PAPER

SKU: AF58103

[Read More](#)

Price: ~~\$7.99~~ \$7.50



-6%

AF58101 FUEL FILTER 2 1/16" FOR 1968-1975

SKU: AF58101

Paper Fuel Filter for Q-Jet carb 2 1/16" long



[Read More](#)

Price: \$7.99 ~~\$7.50~~



AF56302 ADJUSTABLE BYPASS STYLE FUEL PRESSURE REGULATOR (HIGH PRESSURE FUEL INJECTED)

SKU: AF56302

High Performance Adjustable Bypass Style Fuel Pressure Regulator

30-120 PSI for use with electric fuel pumps and fuel injection, with vacuum / boost reference.

Recommended for use serious high-output N/A and most boosted applications.

-10 AN inlet (1) / outlet (2). Mounting bracket included.

[Read More](#)

Price: \$350.00

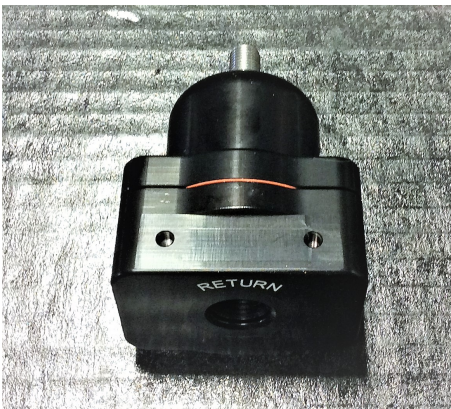

AF56301 ADJUSTABLE BYPASS STYLE FUEL PRESSURE REGULATOR (FUEL INJECTED)

SKU: AF56301

High Performance Adjustable Bypass Style Fuel Pressure Regulator

30-70 PSI for use with electric fuel pumps and fuel injection, with vacuum / boost reference.

With gauge port, -6 AN (O-Ring) inlet (2) / outlet (1). Mounting bracket included. Includes plug and hose barb fitting for gauge port.

[Read More](#)

Price: \$170.00

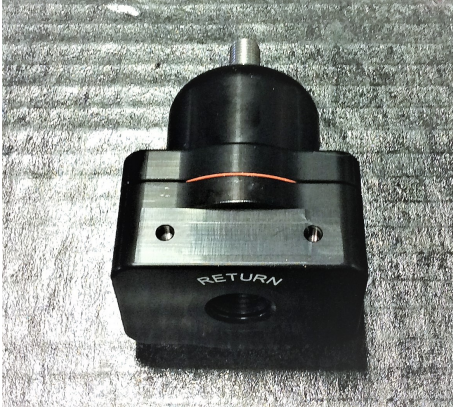

AF56201 ADJUSTABLE BYPASS STYLE FUEL PRESSURE REGULATOR (CARB OR FUEL INJECTED)

SKU: AF56201

High Performance Adjustable Bypass Style Fuel Pressure Regulator

Recommended for use with electric fuel pumps
3-60 PSI for electric pumps with carbureted or fuel injected applications, with vacuum / boost reference.
3/8" NPT inlet (1) / outlet (3). Mounting bracket included.

This is the way to go if you're buying an electric pump and regulator, and plan to go to EFI later, but want to run a carb 'for now'.

[Read More](#)

Price: \$190.00



AF56101 ADJUSTABLE BYPASS STYLE FUEL PRESSURE REGULATOR (CARB)

SKU: AF56101

Adjustable Bypass Style Fuel Pressure Regulator

3-12 PSI for use with mechanical or electric fuel pumps in carbureted applications

3/8 NPT 1x inlet / 1x outlet

[Read More](#)

Price: \$150.00

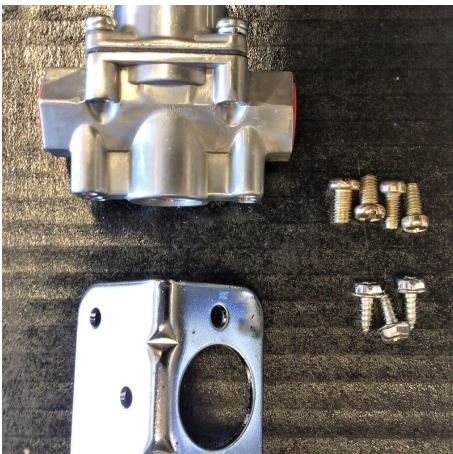

AF56010 ADJUSTABLE FUEL PRESSURE REGULATOR (CARB)

SKU: AF56010

Adjustable Fuel Pressure Regulator

Recommended for use with any mechanical pump needing a regulator, on carbureted applications.

W/ dual outlets for double pumpers or for running a pressure gauge
Satin finish.

[Read More](#)

Price: \$55.00



AF53111 BILLET ALUMINUM FUEL PUMP BLOCK OFF

SKU: AF53111

Billet Aluminum Fuel Pump Block Off

[Read More](#)

Price: \$39.00

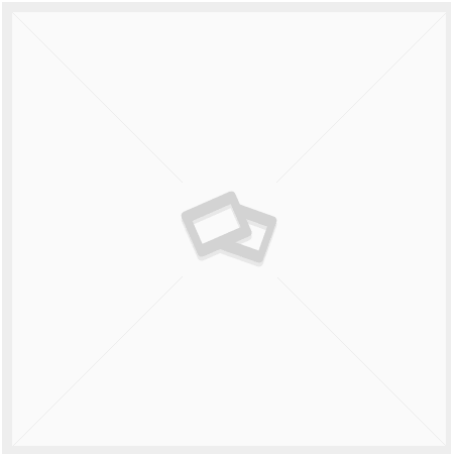

AF53021 IN-TANK PUMP & BAFFLE RETROFIT KIT

SKU: AF53021

Baffled in-tank fuel pump kit for reliable, drivable EFI retrofits with non-EFI OE fuel tanks. No welding required for installation. For 6"-12" deep tanks. 340 lph free-flow.

-6 AN fittings, 90 GPM, supports 800+HP NA
Fits 6"-12" deep tanks, must cut 3.25" hole.

[Read More](#)

Price: \$675.00



AF51250 RACING MECHANICAL FUEL PUMP

SKU: AF51250

Racing Mechanical Fuel Pump

Supports up to 1100 HP, Made in USA

[Read More](#)

Price: \$375.00





AF51230 HIGH PERFORMANCE MECHANICAL FUEL PUMP

SKU: AF51230

High Performance Mechanical Fuel Pump

Supports up to 550 HP, Made in USA

[Read More](#)

Price: \$255.00



AF51210 CHROME MECHANICAL FUEL PUMP

SKU: AF51210

Chrome Mechanical Fuel Pump

[Read More](#)

Price: \$175.00

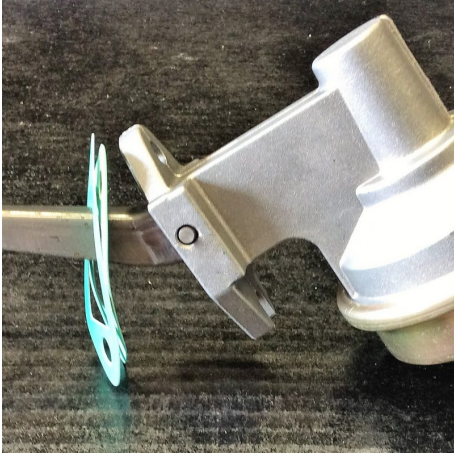

AF51110 OE REPLACEMENT FUEL PUMP

SKU: AF51110

OE Replacement Pump
w/ or w/o return line fitting

[Read More](#)

Price: \$95.00



AF51003 USED FUEL PUMP ECCENTRIC

SKU: AF51003

Billet Steel Fuel Pump Eccentric

[Read More](#)

Price: \$25.00

INTAKE MANIFOLDS



PB34000 R4 BRACKET KIT BILLET ALUMINUM

SKU: PB34000

Billet Aluminum

[Read More](#)

Price: \$324.00



HOGAN INTAKE - LAND SPEED EXTRA

SKU: Hogan Intake

[Read More](#)

Price: \$3,500.00

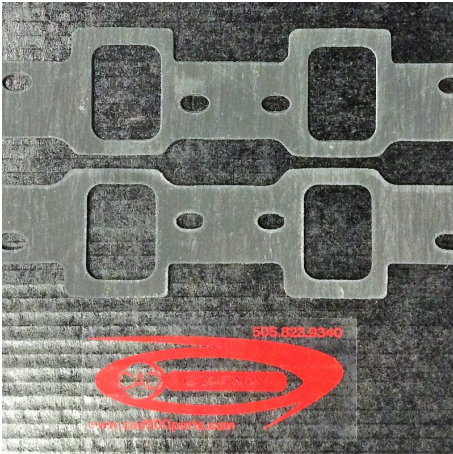

GS21122 BOOGIEMAN™ COMPOSITE INTAKE GASKETS

SKU: GS21122



BoogieMan™ Composite Intake Gaskets

Recommended for use with wide-port BoogieMan™ heads and / or intakes.

Won't come apart when wet.

High quality composite gasket material. Safe for aluminum heads and intakes.

Color may vary.

For iron heads or non-BoogieMan aluminum heads, order [GS21112](#)

Made in USA

[Read More](#)

Price: \$35.00

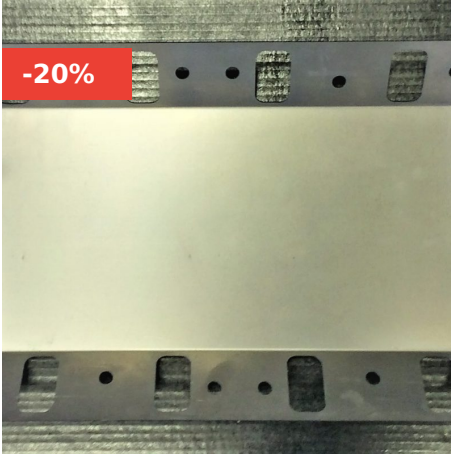

GS21102 HEAVY-DUTY LASER CUT STEEL VALLEY PAN

SKU: GS21102

Heavy-Duty Laser Cut Steel Valley Pan

[Read More](#)

Price: ~~\$50.00~~ \$40.00



AF72215 CAD COMPANY PRO/CAD™ III

SKU: AF72215-0

PC3 Ported Aluminum Dual Plane Intake

[Read More](#)

Price: \$721.76 - \$758.86



AF72115 EDELBROCK™ 2115

SKU: AF72115-0

Edelbrock™ 2115 cast hi rise dual plane intake manifold

[Read More](#)

Price: \$526.95 - \$564.05

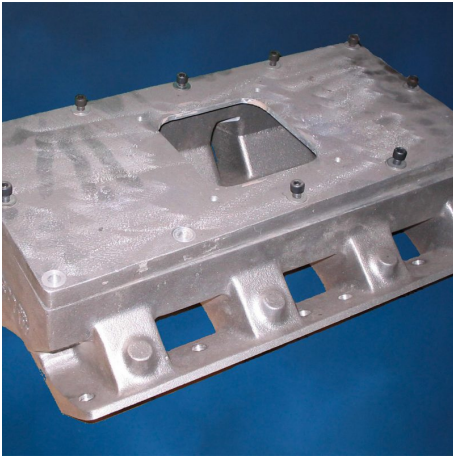

AF71480 BOOGIEMAN™ TUNNEL RAM

SKU: AF71480

The hot ticket for running multiple carbs and high RPM.

[Read More](#)

Price: \$695.00



AF71475 BOOGIEMAN™ SINGLE PLANE INTAKE

SKU: AF71475

This is the king of the hill when it comes to single carb intakes.

[Read More](#)

Price: \$695.00

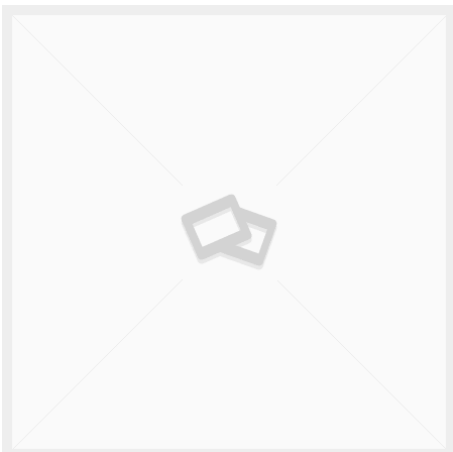

AF71105 SMALL SINGLE PLANE INTAKE STANDARD (SQUARE BORE (4150) STYLE)

SKU: AF71105

Standard square bore (4150) style

[Read More](#)

Price: \$790.00



AF70201 EGR BLOCK OFF FOR OE INTAKES, BILLET ALUMINUM

SKU: AF70201

[Read More](#)

Price: \$30.00



AF70102 FLANGE HEAD INTAKE BOLT KIT - STAINLESS STEEL

SKU: AF70102

Stainless Steel Flange Head Intake Bolt Kit

[Read More](#)

Price: \$25.00



CADWARE



MS31103 CAP WITH LOGO BLACK

SKU: MS31103

Black

[Read More](#)

Price: \$10.00



MS31102 CAP WITH LOGO KHAKI

SKU: MS31102

Khaki

[Read More](#)

Price: \$10.00



MS31101 CAP WITH LOGO RED

SKU: MS31101

Red

[Read More](#)

Price: \$10.00

COOLING SYSTEM

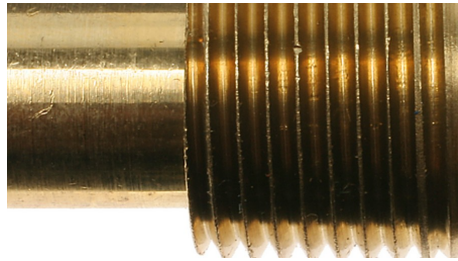

WS21101 COOLANT TEMPERATURE SWITCH

SKU: WS21101

Coolant temperature switch for warning light.

For carbureted Cadillac 472 / 500 / 425 / 368 engines.

1 per engine.

[Read More](#)

Price: \$55.63



VT11022 425/368 STAINLESS TIMING COVER

SKU: VT11022

425/368 Stainless Steel Timing Cover

[Read More](#)

Price: \$95.00

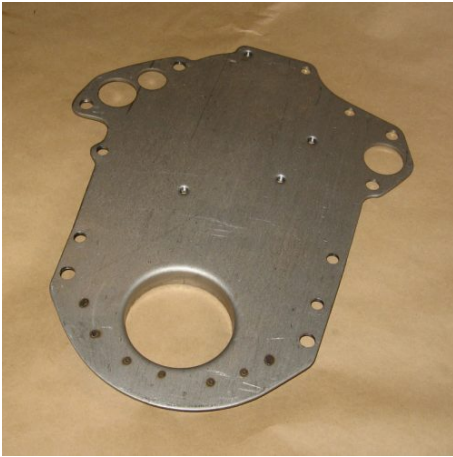

VT11021 472/500 STAINLESS TIMING COVER

SKU: VT11021

472/500 Stainless Steel Timing Cover

[Read More](#)

Price: \$125.00



VT11011 472/500 TIMING COVER

SKU: VT11011

472/500 Timing Cover

[Read More](#)

Price: \$85.00



GS41602 STATITE™ THERMOSTAT GASKET

SKU: GS41602

StaTite™ Thermostat Gasket

[Read More](#)

Price: \$2.75



CS65101 RADIATOR CAP 20 PSI

SKU: CS65101

Correct pressure for Cadillac applications.
Fits most common radiators in Cadillacs and swap vehicles.

[Read More](#)

Price: \$12.00



CS45121 THERMOSTAT HOUSING / WATER NECK, 1" OFFSET BILLET ALUMINUM

SKU: CS45121

Billet Aluminum

[Read More](#)

Price: \$135.00

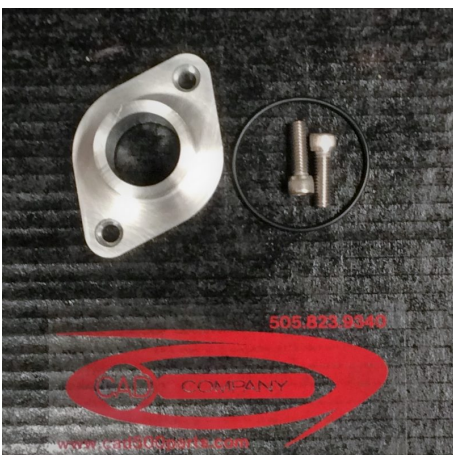

CS45111 THERMOSTAT HOUSING / WATER NECK BILLET ALUMINUM

SKU: CS45111

Billet Aluminum

[Read More](#)

Price: \$85.00



CS41121 THERMOSTAT, HIGH FLOW, 180 DEGREE LOW TEMP

SKU: CS41121

Low Temp

[Read More](#)

Price: \$40.00



CS41102 THERMOSTAT, STANDARD, 195 DEGREE OE TEMP

SKU: CS41102

OE Temp

[Read More](#)

Price: \$25.00



CS41101 THERMOSTAT, STANDARD, 180 DEGREE LOW TEMP

SKU: CS41101

Low Temp

[Read More](#)

Price: \$15.00



CS25102 HIGH VOLUME WATER PUMP (LATE STYLE), BY FLOWKOOLER

SKU: CS25102

High Volume Water Pump Late style, by FlowKooler

Recommended for use with 1-groove V-belt PS / AC systems ('74-'85), and serpentine systems.

[Read More](#)

Price: \$165.00

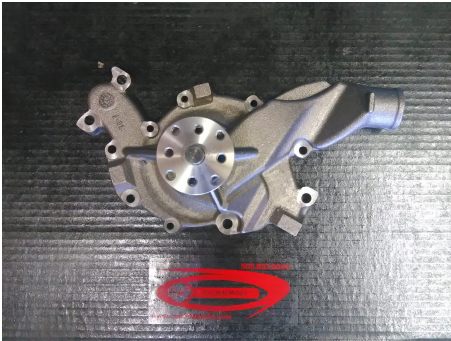

CS25101 HIGH VOLUME WATER PUMP (EARLY STYLE), BY FLOWKOOLER

SKU: CS25101

High Volume Water Pump Early style, by FlowKooler

Recommended for use with 2-groove PS / AC systems ('68-'73).

This product has been at least temporarily discontinued by the manufacturer. FlowKooler was using stock replacement castings to build these, and the stock replacement castings appear to have been discontinued by the the manufacturer. We are working on a solution for those needing a pump to clear the dual-AC belt applications. In the mean time, the easiest solution is to use the late style pump and change the pulleys.

[Read More](#)

Price: \$165.00



CS25001 CHEVY WATER PUMP ADAPTER KIT BILLET ALUMINUM

SKU: CS25001

Chevy Water Pump Adapter Kit Billet Aluminum
Fits 1st Gen SB Chevy water pumps ('55-'00).

[Read More](#)

Price: \$95.00



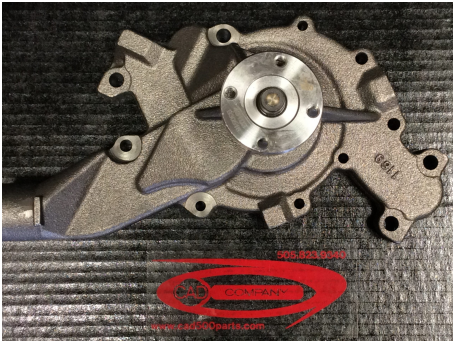

CS21102 NEW REPLACEMENT WATER PUMP (LATE STYLE)

SKU: CS21102

New Replacement Water Pump Late style

Recommended for use with 1-groove V-belt PS / AC systems ('74-'85), and serpentine systems.

[Read More](#)

Price: \$120.00

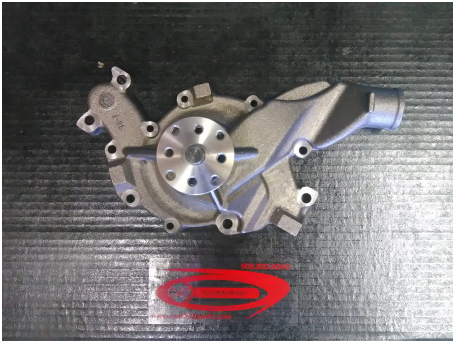

CS21101 NEW STOCK REPLACEMENT WATER PUMP (EARLY STYLE)

SKU: CS21101

New Stock Replacement Water Pump Early style

Recommended for use with 2-groove PS / AC systems ('68-'73).

This product appears to have been discontinued by the the manufacturer. We are working on a solution for those needing a pump to clear the dual-AC belt applications. In the mean time, the easiest solution is to use the late style pump and change the pulleys.

[Read More](#)

Price: \$120.00

BH15013 FREEZE PLUG KIT FOR 425 HEADS

SKU: N/A

Freeze Plug Kit for 425 Heads

Kit includes 4 disc type plugs and 2 cup type plugs (does not include water outlet).

1 Kit per engine

[Read More](#)

Price: \$5.00 - \$20.00





BH13371 BLOCK COOLANT SENSOR HOLES, THREADED PLUG

SKU: xBH13371

0-2 per engine

[Read More](#)

Price: \$9.50



BH13172 BLOCK COOLANT PLUG, THREADED

SKU: xBH13172

0-2 per engine

[Read More](#)

Price: \$9.50



BH13143 OIL GALLEY THREADED PLUG

SKU: BH13143

3/8" Pipe Thread Plugs

3-4 per engine - rear of main oil galleys, oil pressure access port above oil pump, and coolant port just below thermostat housing.

[Read More](#)

Price: \$0.40

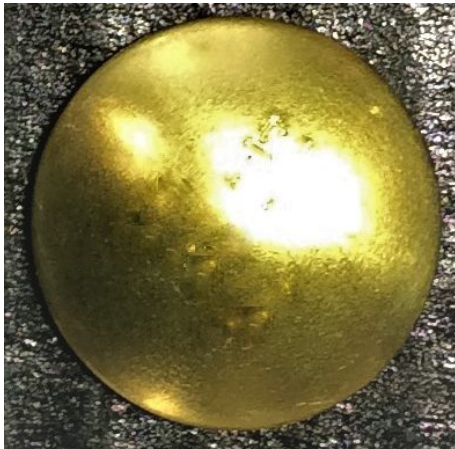

BH12396 HEAD COOLANT PLUG, DISC STYLE, BRASS

SKU: BH12396

Brass Disc Style Head Coolant Plug

[Read More](#)

Price: \$3.78



BH11X93 BLOCK EXPANSION PLUGS (STEEL OR BRASS)

SKU: BH11X93

Block Expansion Plugs (each)

req. 6 per engine

[Read More](#)

Price: \$0.75 - \$3.50

BH11395 HEAD COOLANT PLUG, CUP STYLE

SKU: BH11395

1 per engine, 425 only, replaces press in water outlet

[Read More](#)

Price: \$1.75



BH11011 CAD COMPANY BLOCK HARDWARE KIT

SKU: BH11011

Includes freeze plugs (brass), cam plug, all 7 galley plugs, 4 brass disc type head freeze plugs, 2 smog rail plugs, and block/ head dowel pins.

[Read More](#)

Price: \$53.72



BH10000 HEAD WATER OUTLET KIT, THREADED 90°

SKU: BH10000

[Read More](#)

Price: \$25.00



PLUGS



BH15013 FREEZE PLUG KIT FOR 425 HEADS

SKU: N/A

Freeze Plug Kit for 425 Heads

Kit includes 4 disc type plugs and 2 cup type plugs (does not include water outlet).

1 Kit per engine

[Read More](#)

Price: \$5.00 - \$20.00



BH13371 BLOCK COOLANT SENSOR HOLES, THREADED PLUG

SKU: xBH13371

0-2 per engine

[Read More](#)

Price: \$9.50





BH13172 BLOCK COOLANT PLUG, THREADED

SKU: xBH13172

0-2 per engine

[Read More](#)

Price: \$9.50



BH13143 OIL GALLEY THREADED PLUG

SKU: BH13143

3/8" Pipe Thread Plugs

3-4 per engine - rear of main oil galleys, oil pressure access port above oil pump, and coolant port just below thermostat housing.

[Read More](#)

Price: \$0.40

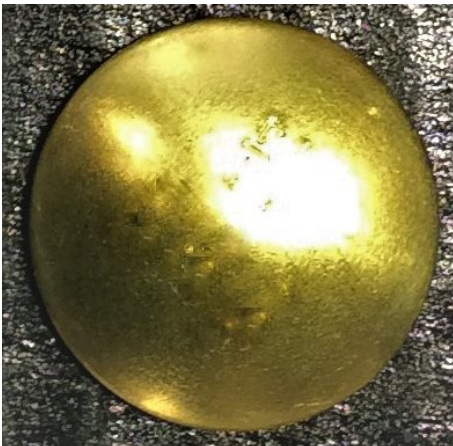

BH12396 HEAD COOLANT PLUG, DISC STYLE, BRASS

SKU: BH12396

Brass Disc Style Head Coolant Plug

[Read More](#)

Price: \$3.78



BH11X93 BLOCK EXPANSION PLUGS (STEEL OR BRASS)

SKU: BH11X93

Block Expansion Plugs (each)

req. 6 per engine

[Read More](#)

Price: \$0.75 - \$3.50



BH11395 HEAD COOLANT PLUG, CUP STYLE

SKU: BH11395

1 per engine, 425 only, replaces press in water outlet

[Read More](#)

Price: \$1.75



BH11011 CAD COMPANY BLOCK HARDWARE KIT

SKU: BH11011

Includes freeze plugs (brass), cam plug, all 7 galley plugs, 4 brass disc type head freeze plugs, 2 smog rail plugs, and block/ head dowel pins.

[Read More](#)

Price: \$53.72



BH10000 HEAD WATER OUTLET KIT, THREADED 90°

SKU: BH10000

[Read More](#)

Price: \$25.00



RADIATOR

Radiators, radiator caps, and other related items.



CS65101 RADIATOR CAP 20 PSI

SKU: CS65101

Correct pressure for Cadillac applications.
Fits most common radiators in Cadillacs and swap vehicles.

[Read More](#)

Price: \$12.00

THERMOSTATS AND HOUSINGS

Thermostats, thermostat housings, thermostat gaskets, and related parts.

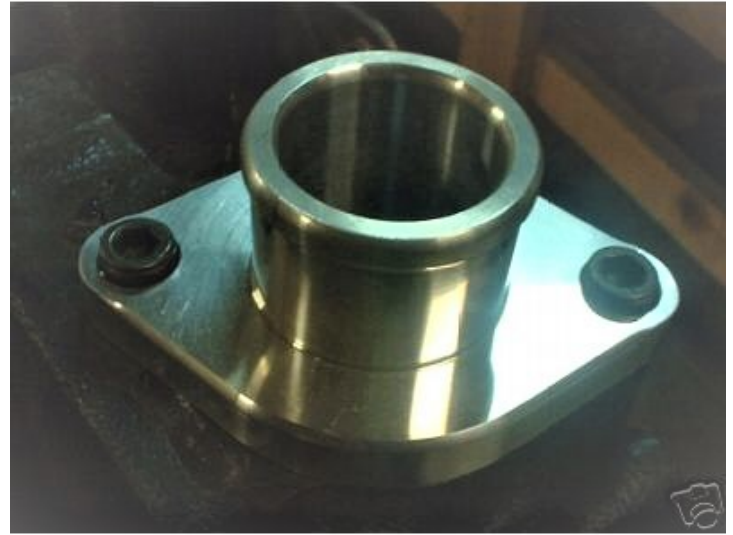

GS41602 STATITE™ THERMOSTAT GASKET

SKU: GS41602

StaTite™ Thermostat Gasket

[Read More](#)

Price: \$2.75



CS45121 THERMOSTAT HOUSING / WATER NECK, 1" OFFSET BILLET ALUMINUM

SKU: CS45121

Billet Aluminum

[Read More](#)

Price: \$135.00



CS45111 THERMOSTAT HOUSING / WATER NECK BILLET ALUMINUM

SKU: CS45111

Billet Aluminum

[Read More](#)

Price: \$85.00



CS41121 THERMOSTAT, HIGH FLOW, 180 DEGREE LOW TEMP

SKU: CS41121

Low Temp

[Read More](#)

Price: \$40.00



CS41102 THERMOSTAT, STANDARD, 195 DEGREE OE TEMP

SKU: CS41102

OE Temp

[Read More](#)

Price: \$25.00



CS41101 THERMOSTAT, STANDARD, 180 DEGREE LOW TEMP

SKU: CS41101

Low Temp

[Read More](#)

Price: \$15.00

WATER PUMPS

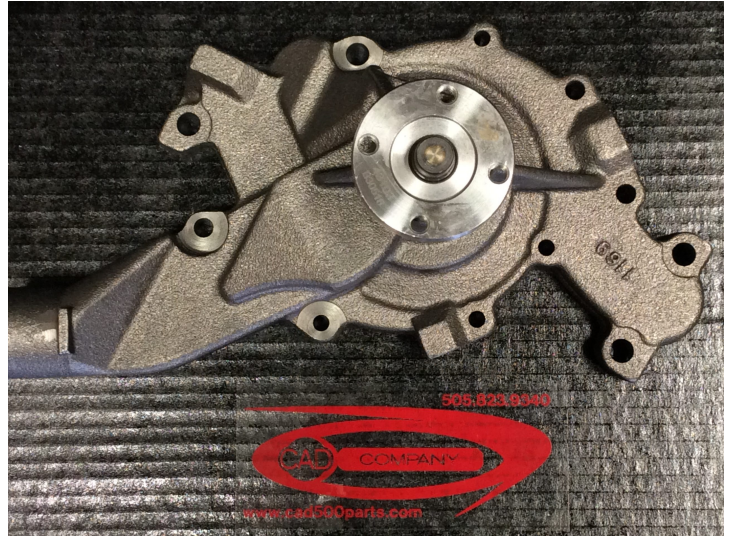

CS25102 HIGH VOLUME WATER PUMP (LATE STYLE), BY FLOWKOOLER

SKU: CS25102

High Volume Water Pump Late style, by FlowKooler

Recommended for use with 1-groove V-belt PS / AC systems ('74-'85), and serpentine systems.

[Read More](#)

Price: \$165.00

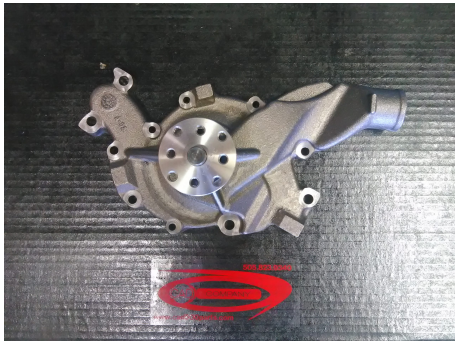

CS25101 HIGH VOLUME WATER PUMP (EARLY STYLE), BY FLOWKOOLER

SKU: CS25101

High Volume Water Pump Early style, by FlowKooler

Recommended for use with 2-groove PS / AC systems ('68-'73).

This product has been at least temporarily discontinued by the manufacturer. FlowKooler was using stock replacement castings to build these, and the stock replacement castings appear to have been discontinued by the the manufacturer. We are working on a solution for those needing a pump to clear the dual-AC belt applications. In the mean time, the easiest solution is to use the late style pump and change the pulleys.

[Read More](#)

Price: \$165.00





CS25001 CHEVY WATER PUMP ADAPTER KIT BILLET ALUMINUM

SKU: CS25001

Chevy Water Pump Adapter Kit Billet Aluminum
Fits 1st Gen SB Chevy water pumps ('55-'00).

[Read More](#)

Price: \$95.00



CS21102 NEW REPLACEMENT WATER PUMP (LATE STYLE)

SKU: CS21102

New Replacement Water Pump Late style

Recommended for use with 1-groove V-belt PS / AC systems ('74-'85), and serpentine systems.

[Read More](#)

Price: \$120.00

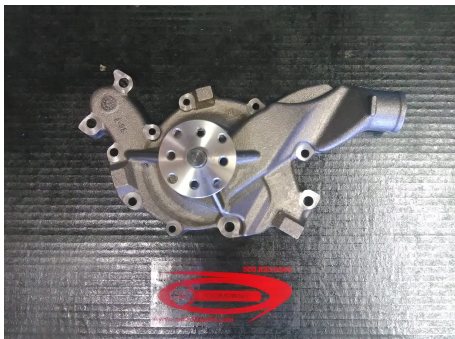

CS21101 NEW STOCK REPLACEMENT WATER PUMP (EARLY STYLE)

SKU: CS21101

New Stock Replacement Water Pump Early style

Recommended for use with 2-groove PS / AC systems ('68-'73).

This product appears to have been discontinued by the the manufacturer. We are working on a solution for those needing a pump to clear the dual-AC belt applications. In the mean time, the easiest solution is to use the late style pump and change the pulleys.

[Read More](#)

Price: \$120.00

DRIVELINE

Driveline, transmission, and starter related components.

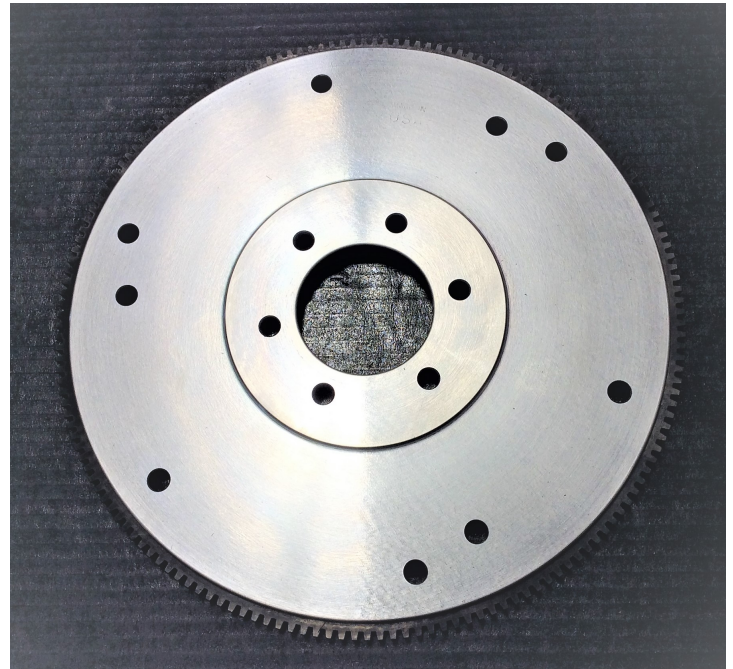

KDS31301 TRANSMISSION ADAPTER 331/365/390/429 TO CHEVY TRANSMISSION

SKU: KDS31301

Transmission Adapter 331/365/390/429 to Chevy Transmission

[Read More](#)

Price: \$2,200.00



DS53111 TRANSMISSION PAN TH425

SKU: DS53111

Special order only

[Read More](#)

Price: \$396.00



DS31203 CADILLAC 429 TO BOP / CADILLAC TRANSMISSION ADAPTER

SKU: kDS31203

Cadillac 429 Engine to BOP / '68-up Cadillac Transmission Adapter Kit. 5/16 cold rolled steel, CNC cut bolt holes and threads. Includes countersunk bolts (4) and 1 piece flex plate spacers(3).

Fits '64-'67 Cadillac 429 engine with starter mounting bolt holes in the block.

[Read More](#)

Price: \$140.00



DS31201 CADILLAC 429 TO CHEVY TRANSMISSION ADAPTER

SKU: kDS31201

Cadillac 429 Engine to Chevy Transmission Adapter Kit. 5/16 cold rolled steel, CNC cut bolt holes and threads. Includes countersunk bolts (4) and 1 piece flex plate spacers(3).

[Read More](#)

Price: \$140.00

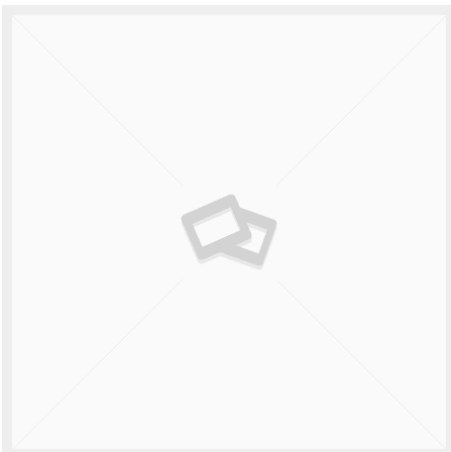

DS31111 TORQUE CONVERTER ADAPTER

SKU: DS31111



Torque Converter Adapter

This adapter can be used to bolt up a torque converter with a light duty bolt pattern (Powerglide, T300, TH350, 700R4, 200R4, 4L60, and many aftermarket performance converters for TH400 and 4L80E) to a flex plate intended for a TH400 or 4L80E.

See detailed description for compatibility information.

[Read More](#)

Price: \$125.00



DS31103 CADILLAC 472/500/425/368 TO CADILLAC 429 SPEC TH400 TRANSMISSION ADAPTER

SKU: DS31103

Cadillac 472/500/425/368 Engine to 429 Cadillac Transmission Adapter Kit. 5/16 cold rolled steel, CNC cut bolt holes and threads. Includes 1 piece flexplate spacers(3) Note: Will not work on some early 429s that had the cast iron adapter.

[Read More](#)

Price: \$160.00



DS31101 CADILLAC TO CHEVY TRANSMISSION ADAPTER

SKU: DS31101

Cadillac 472/500/425/368 Engine to Chevy Transmission Adapter Kit. 5/16 cold rolled steel, CNC cut bolt holes and threads. Includes 1 piece flex plate spacers(3).

[Read More](#)

Price: \$140.00



DS24102 MINI STARTER NOSE CONE UPGRADE

SKU: DS24101-1

Nose cone upgrade for DS24101 starter - must be ordered with a new starter.

[Read More](#)

Price: \$375.00



DS24101 MINI STARTER

SKU: DS24101

Chrome model add \$140

[Read More](#)

Price: \$537.00



DS22113 ELDORADO STARTER

SKU: DS22113

[Read More](#)

Price: \$340.00



DS22101 HD HIGH TORQUE STARTER (FITS ALL RWD)

SKU: DS22101

New High Torque Starter

[Read More](#)

Price: \$190.00



DS20141 STARTER BOLTS OE STYLE FOR FULL SIZE STARTER RWD

SKU: DS20141

Starter Bolts OE Style for full size starter

[Read More](#)

Price: \$15.00



DS20131 STARTER SUPPORT STRAP

SKU: DS20131

\$20 with purchase of a starter.

If you are missing this support strap, your starter nose cone can break from even a minor kickback from the big 472 / 500 engine. It can even fail eventually without a kickback problem.

If you are missing the original starter support bracket, you need t

[Read More](#)

Price: \$29.00



DS13101 CADILLAC PILOT BUSHING FOR MANUAL TRANSMISSION

SKU: DS13101

Fits existing machined hole in crank -
No crank removal or precision machining required in most cases.
For standard GM car/ light truck input shaft size.

[Read More](#)

Price: \$45.00

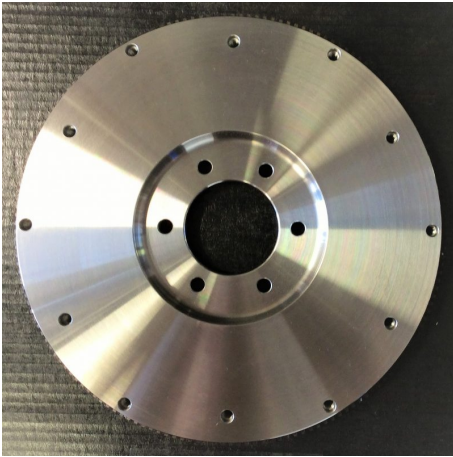

DS12221 BILLET STEEL 429 FLYWHEEL (STANDARD CLUTCHES)

SKU: kDS12221

Billet Steel Flywheel for standard clutches with Cadillac 429 engine.

[Read More](#)

Price: \$435.00

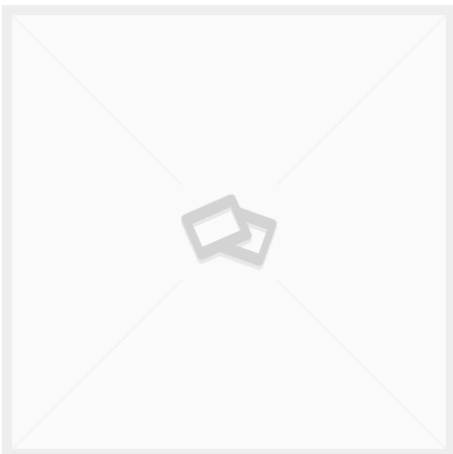

DS12213 BILLET STEEL 429 FLEXPLATE (MULTI-PATTERN) WITH FACTORY ADAPTER.

SKU: kDS12213

Billet Steel Flexplate for automatic transmissions

This flex plate fits '64-'65 Cadillac 429 engines that have a TH400 bolted up with a factory cast iron adapter, and the starter bolted to the transmission adapter. Please see detailed description for identification information before ordering.

[Read More](#)

Price: \$375.00

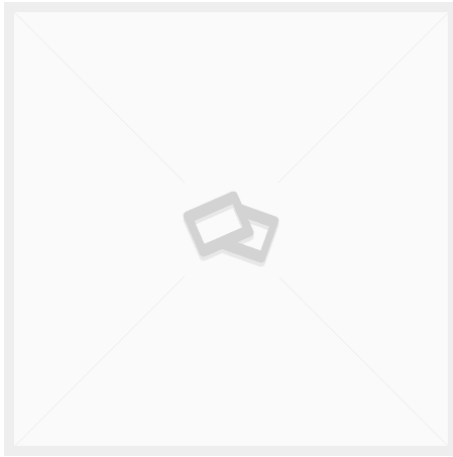

DS12211 BILLET STEEL 429 FLEXPLATE (MULTI-PATTERN)

SKU: kDS12211

Billet Steel Flexplate for automatic transmissions

This flex plate fits '64-'67 Cadillac 429 engines with the TH400 or other modern transmission bolted directly to the block (or using an aftermarket transmission adapter), with the starter bolted directly to the block. Please see detailed description for identification information before ordering.

[Read More](#)

Price: \$375.00



DS12125 BILLET STEEL FLYWHEEL FOR LONG STYLE CLUTCHES

SKU: DS12125

Uses stock starter.

Fits most 10" through 12" car/ light truck 'Long' style clutches (with unevenly spaced 6 bolt pattern).

[Read More](#)

Price: \$380.00



DS12123 BILLET STEEL FLYWHEEL FOR PULL TYPE CLUTCHES

SKU: DS12123

Uses stock starter.

Fits most 10" through 12" car/ light truck pull type clutches (with deep recess in the center of the flywheel, such as found behind most LSX engines).

[Read More](#)

Price: \$480.00

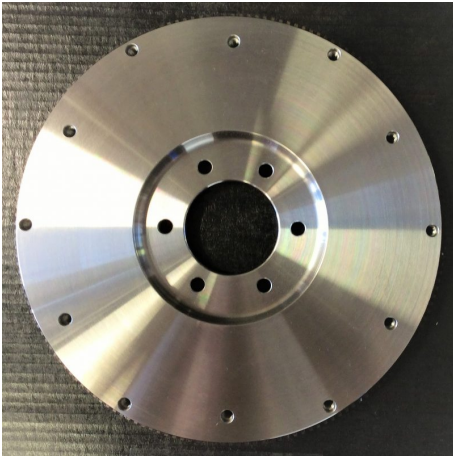

DS12121 BILLET STEEL FLYWHEEL (STANDARD CLUTCHES)

SKU: DS12121

Uses stock starter.
Fits most 10" through 12" car/ light truck clutches.

[Read More](#)

Price: \$395.00



DS12111 BILLET STEEL FLEXPLATE (MULTI- PATTERN)

SKU: DS12111

Uses stock starter.
Fits TH400 / 4L80 (11.5") and TH350 / 700R4 / 200R4 / Powerglide / etc (10.75") converter bolt pattern.

[Read More](#)

Price: \$375.00



DS12103 PERFORMANCE STAMPED STEEL FLEXPLATE DUAL PATTERN, SFI CERTIFIED

SKU: DS12103

Uses stock starter.
Fits TH400 / 4L80 (11.5") and TH350 / 700R4 / 200R4 / Powerglide / etc (10.75") converter bolt pattern.

[Read More](#)

Price: \$205.00



DS12102 PERFORMANCE STAMPED STEEL FLEXPLATE DUAL PATTERN

SKU: DS12102

Uses stock starter.

Fits TH400 / 4L80 (11.5") and TH350 / 700R4 / 200R4 / Powerglide / etc (10.75") converter bolt pattern.

[Read More](#)

Price: \$135.00



DS12101 OE SPEC STAMPED STEEL FLEXPLATE STOCK (REPLACEMENT - SOLID STYLE)

SKU: DS12101

Uses stock starter. Only fits TH400/ TH425 / 4L80E converter bolt pattern.

[Read More](#)

Price: \$105.00



DS10113 FLEXPLATE AND FLYWHEEL BOLTS, ARP, PRO-SERIES CHROMOLY

SKU: DS10113

ARP Heavy Duty Chromoly Flex Plate and Fly Wheel Bolts

Fits with billet steel flexplate or flywheel.

Can also be used with factory, stock replacement, and stamped steel aftermarket flex plates.

Heavy duty bolts for high-power applications.

[Read More](#)

Price: \$45.00



DS10112 FLEXPLATE AND FLYWHEEL BOLTS, ARP CHROMOLY

SKU: DS10112

ARP Chromoly Flex Plate and Fly Wheel Bolts

Fits with billet steel flexplate or flywheel.
Can also be used with factory, stock replacement, and stamped steel aftermarket flex plates.

[Read More](#)

Price: \$39.00



DS10111 FLEXPLATE BOLTS ARP CHROMOLY

SKU: DS10111

ARP Chromoly Flex plate Bolts

Fits with factory, stock replacement, and stamped steel aftermarket flex plates.
Does not fit billet steel flexplate or flywheel.

[Read More](#)

Price: \$40.00

FLEX PLATES, FLYWHEELS, AND RING GEARS



DS31111 TORQUE CONVERTER ADAPTER

SKU: DS31111

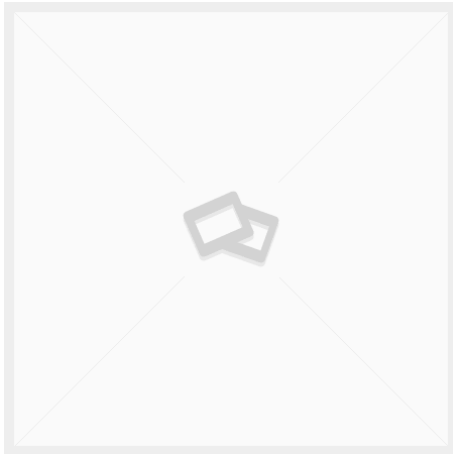

Torque Converter Adapter

This adapter can be used to bolt up a torque converter with a light duty bolt pattern (Powerglide, T300, TH350, 700R4, 200R4, 4L60, and many aftermarket performance converters for TH400 and 4L80E) to a flex plate intended for a TH400 or 4L80E.

See detailed description for compatibility information.

[Read More](#)

Price: \$125.00

DS13101 CADILLAC PILOT BUSHING FOR MANUAL TRANSMISSION

SKU: DS13101

Fits existing machined hole in crank -
No crank removal or precision machining required in most cases.
For standard GM car/ light truck input shaft size.

[Read More](#)

Price: \$45.00



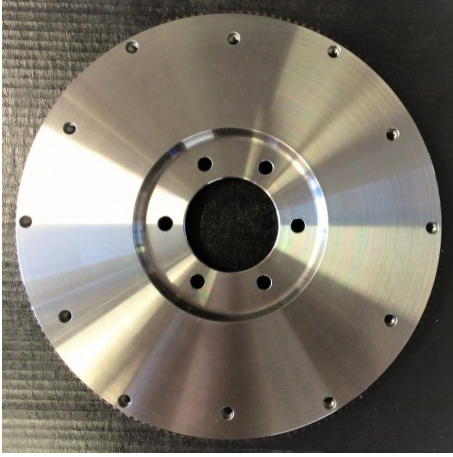

DS12221 BILLET STEEL 429 FLYWHEEL (STANDARD CLUTCHES)

SKU: kDS12221

Billet Steel Flywheel for standard clutches with Cadillac 429 engine.

[Read More](#)

Price: \$435.00

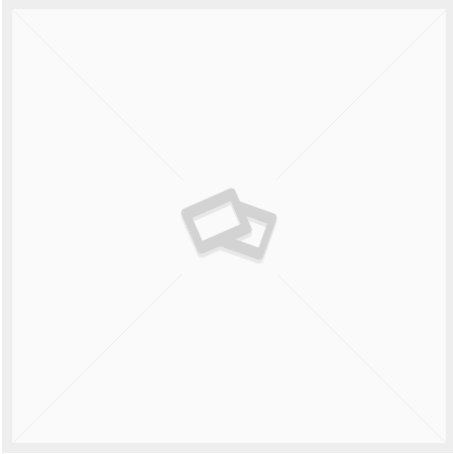

DS12213 BILLET STEEL 429 FLEXPLATE (MULTI-PATTERN) WITH FACTORY ADAPTER.

SKU: kDS12213

Billet Steel Flexplate for automatic transmissions

This flex plate fits '64-'65 Cadillac 429 engines that have a TH400 bolted up with a factory cast iron adapter, and the starter bolted to the transmission adapter. Please see detailed description for identification information before ordering.

[Read More](#)

Price: \$375.00

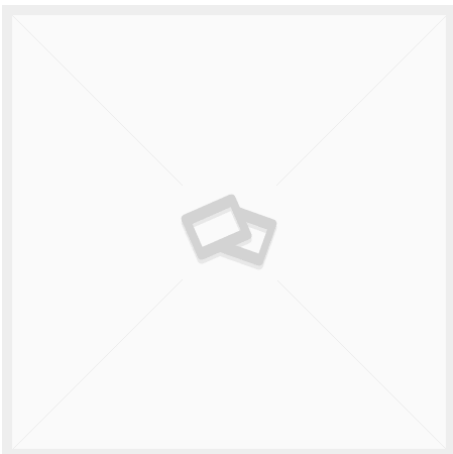

DS12211 BILLET STEEL 429 FLEXPLATE (MULTI-PATTERN)

SKU: kDS12211

Billet Steel Flexplate for automatic transmissions

This flex plate fits '64-'67 Cadillac 429 engines with the TH400 or other modern transmission bolted directly to the block (or using an aftermarket transmission adapter), with the starter bolted directly to the block. Please see detailed description for identification information before ordering.

[Read More](#)

Price: \$375.00



DS12125 BILLET STEEL FLYWHEEL FOR LONG STYLE CLUTCHES

SKU: DS12125

Uses stock starter.
Fits most 10" through 12" car/ light truck 'Long' style clutches (with unevenly spaced 6 bolt pattern).

[Read More](#)

Price: \$380.00



DS12123 BILLET STEEL FLYWHEEL FOR PULL TYPE CLUTCHES

SKU: DS12123

Uses stock starter.
Fits most 10" through 12" car/ light truck pull type clutches (with deep recess in the center of the flywheel, such as found behind most LSX engines).

[Read More](#)

Price: \$480.00

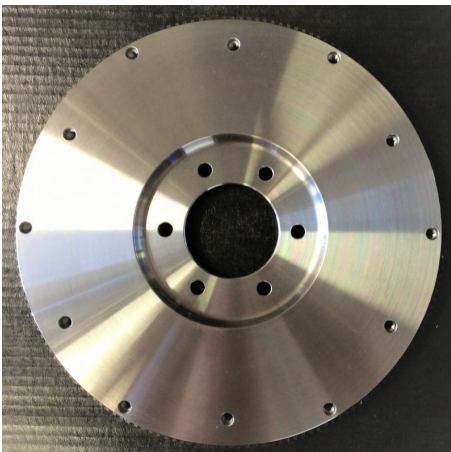

DS12121 BILLET STEEL FLYWHEEL (STANDARD CLUTCHES)

SKU: DS12121

Uses stock starter.
Fits most 10" through 12" car/ light truck clutches.

[Read More](#)

Price: \$395.00



DS12111 BILLET STEEL FLEXPLATE (MULTI-PATTERN)

SKU: DS12111

Uses stock starter.
Fits TH400 / 4L80 (11.5") and TH350 / 700R4 / 200R4 / Powerglide / etc (10.75") converter bolt pattern.

[Read More](#)

Price: \$375.00



DS12103 PERFORMANCE STAMPED STEEL FLEXPLATE DUAL PATTERN, SFI CERTIFIED

SKU: DS12103

Uses stock starter.
Fits TH400 / 4L80 (11.5") and TH350 / 700R4 / 200R4 / Powerglide / etc (10.75") converter bolt pattern.

[Read More](#)

Price: \$205.00



DS12102 PERFORMANCE STAMPED STEEL FLEXPLATE DUAL PATTERN

SKU: DS12102

Uses stock starter.
Fits TH400 / 4L80 (11.5") and TH350 / 700R4 / 200R4 / Powerglide / etc (10.75") converter bolt pattern.

[Read More](#)

Price: \$135.00



DS12101 OE SPEC STAMPED STEEL FLEXPLATE STOCK (REPLACEMENT - SOLID STYLE)

SKU: DS12101

Uses stock starter. Only fits TH400/ TH425 / 4L80E converter bolt pattern.

[Read More](#)

Price: \$105.00



DS10113 FLEXPLATE AND FLYWHEEL BOLTS, ARP, PRO-SERIES CHROMOLY

SKU: DS10113

ARP Heavy Duty Chromoly Flex Plate and Fly Wheel Bolts

Fits with billet steel flexplate or flywheel.

Can also be used with factory, stock replacement, and stamped steel aftermarket flex plates.

Heavy duty bolts for high-power applications.

[Read More](#)

Price: \$45.00



DS10112 FLEXPLATE AND FLYWHEEL BOLTS, ARP CHROMOLY

SKU: DS10112

ARP Chromoly Flex Plate and Fly Wheel Bolts

Fits with billet steel flexplate or flywheel.

Can also be used with factory, stock replacement, and stamped steel aftermarket flex plates.

[Read More](#)

Price: \$39.00



DS10111 FLEXPLATE BOLTS ARP CHROMOLY

SKU: DS10111

ARP Chromoly Flex plate Bolts

Fits with factory, stock replacement, and stamped steel aftermarket flex plates.

Does not fit billet steel flexplate or flywheel.

[Read More](#)

Price: \$40.00

STARTERS



DS24102 MINI STARTER NOSE CONE UPGRADE

SKU: DS24101-1

Nose cone upgrade for DS24101 starter - must be ordered with a new starter.

[Read More](#)

Price: \$375.00



DS24101 MINI STARTER

SKU: DS24101

Chrome model add \$140

[Read More](#)

Price: \$537.00

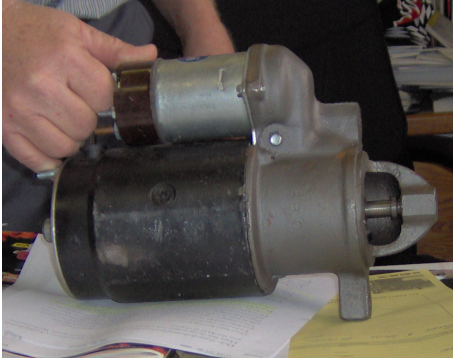

DS22113 ELDORADO STARTER

SKU: DS22113

[Read More](#)

Price: \$340.00



DS22101 HD HIGH TORQUE STARTER (FITS ALL RWD)

SKU: DS22101

New High Torque Starter

[Read More](#)

Price: \$190.00



DS20141 STARTER BOLTS OE STYLE FOR FULL SIZE STARTER RWD

SKU: DS20141

Starter Bolts OE Style for full size starter

[Read More](#)

Price: \$15.00



DS20131 STARTER SUPPORT STRAP

SKU: DS20131

\$20 with purchase of a starter.

If you are missing this support strap, your starter nose cone can break from even a minor kickback from the big 472 / 500 engine. It can even fail eventually without a kickback problem.

If you are missing the original starter support bracket, you need t

[Read More](#)

Price: \$29.00

TRANSMISSION ADAPTERS



KDS31301 TRANSMISSION ADAPTER 331/365/390/429 TO CHEVY TRANSMISSION

SKU: kds31301

Transmission Adapter 331/365/390/429 to Chevy Transmission

[Read More](#)

Price: \$2,200.00

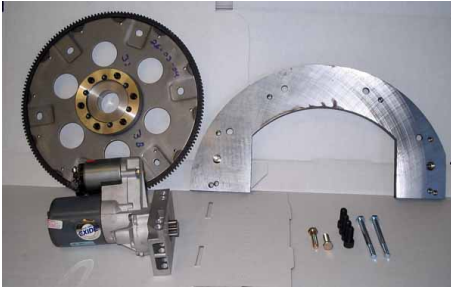

DS31203 CADILLAC 429 TO BOP / CADILLAC TRANSMISSION ADAPTER

SKU: kds31203

Cadillac 429 Engine to BOP / '68-up Cadillac Transmission Adapter Kit. 5/16 cold rolled steel, CNC cut bolt holes and threads. Includes countersunk bolts (4) and 1 piece flex plate spacers(3). Fits '64-'67 Cadillac 429 engine with starter mounting bolt holes in the block.

[Read More](#)

Price: \$140.00





DS31201 CADILLAC 429 TO CHEVY TRANSMISSION ADAPTER

SKU: kDS31201

Cadillac 429 Engine to Chevy Transmission Adapter Kit. 5/16 cold rolled steel, CNC cut bolt holes and threads. Includes countersunk bolts (4) and 1 piece flex plate spacers(3).

[Read More](#)

Price: \$140.00

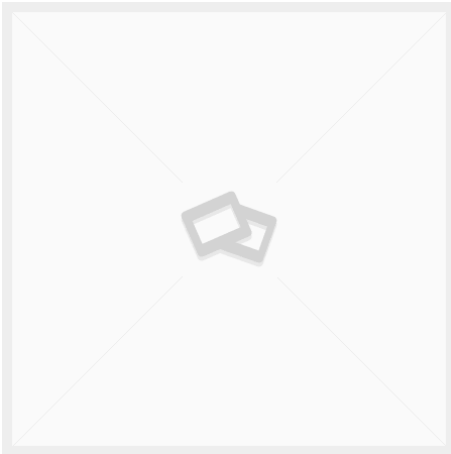

DS31111 TORQUE CONVERTER ADAPTER

SKU: DS31111



Torque Converter Adapter

This adapter can be used to bolt up a torque converter with a light duty bolt pattern (Powerglide, T300, TH350, 700R4, 200R4, 4L60, and many aftermarket performance converters for TH400 and 4L80E) to a flex plate intended for a TH400 or 4L80E.

See detailed description for compatibility information.

[Read More](#)

Price: \$125.00



DS31103 CADILLAC 472/500/425/368 TO CADILLAC 429 SPEC TH400 TRANSMISSION ADAPTER

SKU: DS31103

Cadillac 472/500/425/368 Engine to 429 Cadillac Transmission Adapter Kit. 5/16 cold rolled steel, CNC cut bolt holes and threads. Includes 1 piece flexplate spacers(3) Note: Will not work on some early 429s that had the cast iron adapter.

[Read More](#)

Price: \$160.00



DS31101 CADILLAC TO CHEVY TRANSMISSION ADAPTER

SKU: DS31101

Cadillac 472/500/425/368 Engine to Chevy Transmission Adapter Kit. 5/16 cold rolled steel, CNC cut bolt holes and threads. Includes 1 piece flex plate spacers(3).

[Read More](#)

Price: \$140.00



TRANSMISSION PARTS



DS53111 TRANSMISSION PAN TH425

SKU: DS53111

Special order only

[Read More](#)

Price: \$396.00

EXHAUST



VT91021 CUSTOM VALVE COVERS POWDER COATING

SKU: VT91021

Powder Coating \$175 and up

[Read More](#)

Price: \$175.00

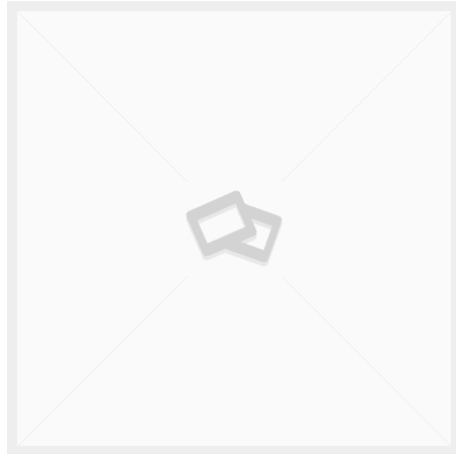

TS11209 EXHAUST BOLT REMOVAL TOOL KIT

SKU: TS11209

Manibolt Driller tool / fixture kit, makes removing broken bolts a 'snap', often without pulling the heads or engine out of the car.

With this precision tool you can drill and tap broken exhaust manifold bolts dead center and perfectly straight, every time, even if you can't see where you're drilling!

This kit fits all '68-'85 Cadillac 472 / 500 / 425 / 368 Cadillac engines.

Kit includes: Bushing Clamp (Qty 3, sizes 1/8 1/4 and 5/16), Drills and Taps (Qty 1 ea. 1/8 1/4 and 5/16 with 3/8-16 Tap), Knurled Thumbscrew for mounting Bushing Clamps, Modified 3/8-16 Stainless Flatheads (Qty 4), and a Rugged plastic case with laser cut foam fitted for dedicated placement.

For more information, see the detailed info tab.

You can also visit Beydler's website [here](#) for how-to videos and more.





[Read More](#)

Price: \$450.00



KEX45211 HEADERS 390/429

SKU: kEX45211

[Read More](#)

Price: \$495.00



GS31131 COMPRESSED GRAPHITE HEADER GASKETS

SKU: GS31131

Compressed Graphite Header Gaskets - 1 Pair



**MADE IN
THE U.S.A.**



[Read More](#)

Price: \$75.00

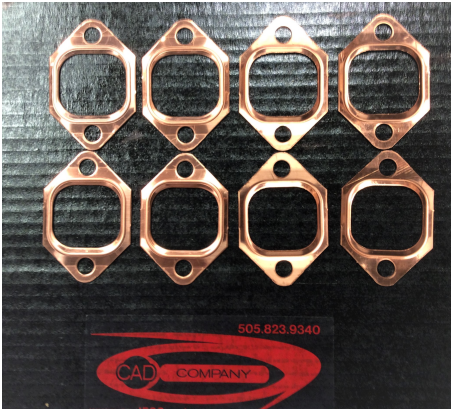

GS31121 SCE COPPER HEADER GASKETS 8 INDIVIDUAL GASKETS

SKU: GS31121

SCE Copper Header Gaskets 8 individual gaskets

[Read More](#)

Price: \$95.00

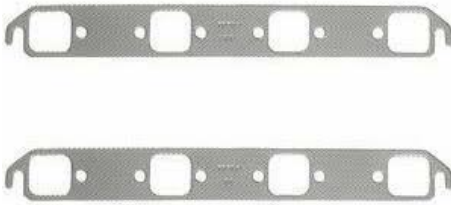

GS31101 EXHAUST MANIFOLD GASKETS

SKU: GS31101

Stock Replacement Exhaust Manifold Gaskets

[Read More](#)

Price: \$20.00

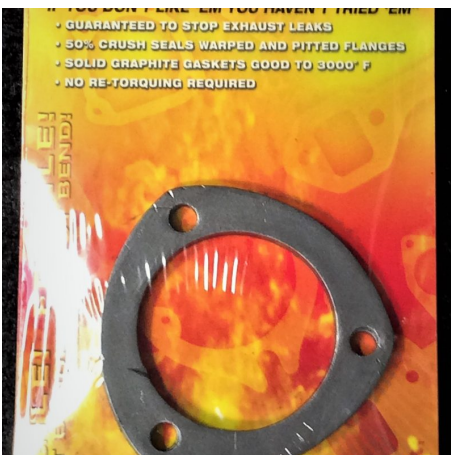

GS30133 REMFLEX COMPRESSED GRAPHITE 3" COLLECTOR GASKETS 1 PR

SKU: GS30133

Compressed Graphite 3" Collector Gaskets 1 pr

[Read More](#)

Price: \$30.00



GS30123 SCE COPPER 3" COLLECTOR GASKETS 1 PR

SKU: GS30123

SCE Copper 3" Collector Gaskets 1 pr

[Read More](#)

Price: \$30.00



GS30113 COMPOSITE 3" COLLECTOR GASKETS 1 PR

SKU: GS30113

Composite 3" Collector Gaskets 1 pr

[Read More](#)

Price: \$15.00



EX67132 3/8" BOOGIEMAN D-PORT HEADER FLANGES (1 PAIR)

SKU: EX67122-1

3/8" 3-Bolt D-port BoogieMan Header Flange (Pair)

[Read More](#)

Price: \$90.00

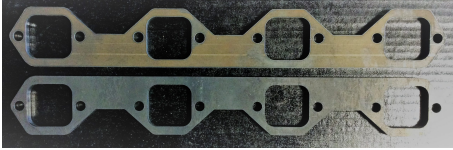

EX67122 3/8" HEADER FLANGES (1 PAIR)

SKU: EX67122

3/8" Header Flange Kit

[Read More](#)

Price: \$90.00



EX63100 HEADER INSTALL KIT

SKU: EX63100

Header installation kit - Includes premium composite header and collector gaskets, 12 point header bolts and lock washers, Collector bolts and lock nuts, and a pair of collector flanges.

Please select composite, copper, or graphite gaskets.

[Read More](#)

Price: \$85.00 - \$165.00



EX41160 '59-'64 CADILLAC HEADERS WITH 472 / 500 / 425 SWAP, 1 3/4"

SKU: EX41160

Mid length headers for '59-'64 Cadillac with 472 / 500 / 425 swap.



**MADE IN
THE U.S.A.**

Premium mid length header. Fits '59-'64 with 472 / 500 / 425 RWD swaps with little or no mods, may also fit some '54-'58 swaps. CNC Mandrel bent, 3/8 flanges, 3" collector. 1 3/4" primaries.

Note that these use a clamp-on collector (included), rather than the traditional 3-bolt collector, due to space limitations.

[Read More](#)

Price: \$575.00 - \$1,020.00



EX41140 G-BODY HEADERS

SKU: EX41140

G-Body mid length swap headers for 472, 500, and 425 CID Cadillac engines.

Designed to fit '77-'87 G-body cars (RWD Malibu, Monte Carlo, El Camino, Cutlass, Grand Prix, Regal, etc.) with our bolt-in motor mount kit. Fits most cars with no modification necessary. Can be used with our universal motor mount kit or a custom mounting solution, but you will want to have the headers in place to ensure a good fit before finalizing the engine mounting location.

Easy fit, no hammer required - properly designed to fit the applications as designed, and perform great.

[Read More](#)

Price: \$550.00 - \$945.00



EX41130 UNIVERSAL REAR-EXIT HEADERS

SKU: EX41130

'77-up RWD Cadillac with a 472, 500, or 425 CID Cadillac engine.

[Read More](#)

Price: \$550.00 - \$990.00



EX41120 '68-'78 ELDORADO HEADERS

SKU: EX41120

Mid length headers for '68-'78 Eldorado

Specifically designed for the big body Eldo.

Easy fit, no hammer required - properly designed to fit the application and perform great.

These headers can also be used in '67 Eldos and '79-'85 Eldos and Seviles with a 472, 500, or 425 CID swap, but may require minor modification. These headers do *not* fit in the FWD GMC motorhome swap.

[Read More](#)

Price: \$550.00 - \$990.00



EX41110 '68-'76 RWD CADILLAC HEADERS

SKU: EX41110

Mid length headers for '68-'76 RWD Cadillac (All exc. Seville).

Specifically designed for '67-'76 Coupe Deville, Sedan Deville, Concourse, Calais, and Fleetwood cars.

Can also be used in '64-'67 RWD Cadillacs with a 472, 500, or 425 CID swap, but often requires minor modification.

Also used for most RWD / rear-steer swaps, such as '72-older Fords, some 50s Oldsmobiles, etc.

Easy fit, no hammer required - properly designed to fit the application and perform great.

[Read More](#)

Price: \$550.00 - \$990.00



EX41100 BLOCK HUGGERS STREET ROD STYLE, CENTER EXIT

SKU: EX41100

Block Hugger Headers

These are the classic street rod header.

The collector is in the center of the engine, pointing straight down.

[Read More](#)

Price: \$395.00 - \$790.00





EX40101 HEADER BOLT SET (12 POINT BLACK OXIDE BOLTS)

SKU: EX40101

Header Bolt Set 16-12 point black oxide bolts

[Read More](#)

Price: \$25.00



EX25122 '80-'85 368 RWD DRIVER'S SIDE EXHAUST MANIFOLD

SKU: EX25122

Reconditioned '80-'85 RWD Driver's Side Exhaust Manifolds w/ indentions and rectangular ports.

[Read More](#)

Price: \$200.00



EX25108 '77-'79 425 ELDORADO DRIVER'S SIDE EXHAUST MANIFOLD

SKU: EX25108

Reconditioned '77-'79 425 Eldorado Driver's Side Exhaust Manifold

[Read More](#)

Price: \$325.00



EX25107 '77-'79 425 RWD DRIVER'S SIDE EXHAUST MANIFOLD

SKU: EX25107

Reconditioned '77-'79 425 RWD Driver's Side Exhaust Manifold

[Read More](#)

Price: \$275.00



EX25106 '77-'79 425 PASSENGER'S SIDE EXHAUST MANIFOLD

SKU: EX25106

Reconditioned '77-'79 425 Passenger's Side (RWD and Eldo)

[Read More](#)

Price: \$325.00



EX25105 '68-'76 ELDORADO DRIVER'S SIDE EXHAUST MANIFOLD

SKU: EX25105

Reconditioned '68-'76 Eldorado Driver's Side Exhaust Manifold

[Read More](#)

Price: \$325.00



EX25104 '68-'72 ELDORADO PASSENGER'S SIDE EXHAUST MANIFOLD

SKU: EX25104

Reconditioned '68-'72 Eldorado Passenger's Side Exhaust Manifold

[Read More](#)

Price: \$325.00

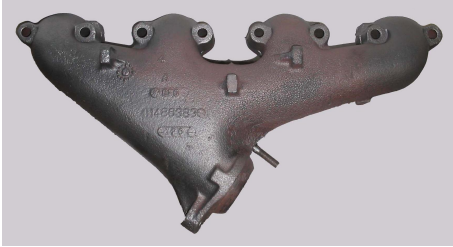

EX25103 '68-'76 RWD DRIVER'S SIDE EXHAUST MANIFOLD

SKU: EX25103

Reconditioned '68-'76 RWD Driver's Side Exhaust Manifold

[Read More](#)

Price: \$250.00



EX25101 '68-'76 RWD AND '73-'76 ELDORADO PASSENGER'S SIDE EXHAUST MANIFOLD (CONE)

SKU: EX25101

Reconditioned '68-'76 RWD and '73-'76 Eldo Passenger's Side
With cone for connecting the exhaust down-pipe directly to the manifold.

[Read More](#)

Price: \$275.00



EX21105 '68-'76 ELDORADO LEFT SIDE MANIFOLD NEW, IMPORTED

SKU: EX21105

'68-'76 Eldorado Left Side Manifold New, imported

[Read More](#)

Price: \$375.00



EX20111 EXHAUST MANIFOLD COLLECTOR STUDS W/ BRASS NUTS

SKU: EX20111

Exhaust Manifold Collector Studs w/ Brass Nuts

Stud and nut kit for exhaust manifolds (for attaching pipes directly to manifolds, without EFE valve). Steel stud with brass nut, 2 each (1 manifold worth) Fits 472 / 500 / 425 manifolds. 368 Manifolds need 1.5 kits per manifold (3 studs).

[Read More](#)

Price: \$12.00

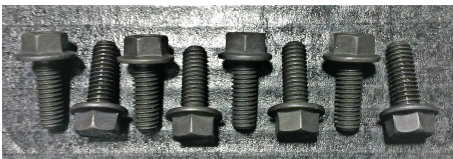

EX20102 EXHAUST MANIFOLD BOLT SET, SHORT (8 BOLT SET) BLACK FLANGE HEAD HEX BOLTS

SKU: EX20102

Short exhaust manifold bolts (1" long bolts), 1/2 set (8 bolts) 2 sets required per engine.

[Read More](#)

Price: \$12.00

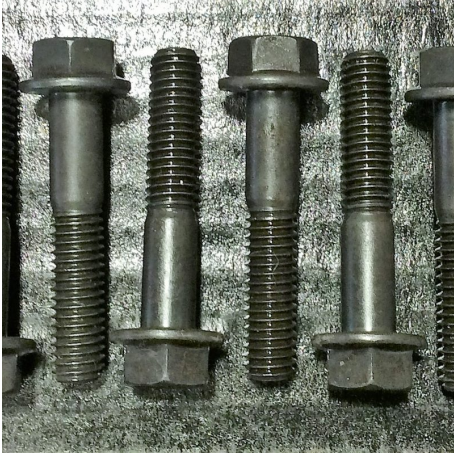

EX20101 EXHAUST MANIFOLD BOLT SET, LONG (8 BOLT SET) BLACK FLANGE HEAD HEX BOLTS

SKU: EX20101

Long exhaust manifold bolts (2" long bolts), 1/2 set (8 bolts) 2 sets required per engine.

[Read More](#)

Price: \$12.00



AF70201 EGR BLOCK OFF FOR OE INTAKES, BILLET ALUMINUM

SKU: AF70201

[Read More](#)

Price: \$30.00

EXHAUST MANIFOLDS



TS11209 EXHAUST BOLT REMOVAL TOOL KIT

SKU: TS11209

Manibolt Driller tool / fixture kit, makes removing broken bolts a 'snap', often without pulling the heads or engine out of the car.

With this precision tool you can drill and tap broken exhaust manifold bolts dead center and perfectly straight, every time, even if you can't see where you're drilling!

This kit fits all '68-'85 Cadillac 472 / 500 / 425 / 368 Cadillac engines.

Kit includes: Bushing Clamp (Qty 3, sizes 1/8 1/4 and 5/16), Drills and Taps (Qty 1 ea. 1/8 1/4 and 5/16 with 3/8-16 Tap), Knurled Thumbscrew for mounting Bushing Clamps, Modified 3/8-16 Stainless Flatheads (Qty 4), and a Rugged plastic case with laser cut foam fitted for dedicated placement.

For more information, see the detailed info tab.

You can also visit Beydler's website [here](#) for how-to videos and more.

[Read More](#)

Price: \$450.00



GS31101 EXHAUST MANIFOLD GASKETS

SKU: GS31101

Stock Replacement Exhaust Manifold Gaskets

[Read More](#)

Price: \$20.00



EX25122 '80-'85 368 RWD DRIVER'S SIDE EXHAUST MANIFOLD

SKU: EX25122

Reconditioned '80-'85 RWD Driver's Side Exhaust Manifolds w/ indentions and rectangular ports.

[Read More](#)

Price: \$200.00



EX25108 '77-'79 425 ELDORADO DRIVER'S SIDE EXHAUST MANIFOLD

SKU: EX25108

Reconditioned '77-'79 425 Eldorado Driver's Side Exhaust Manifold

[Read More](#)

Price: \$325.00



EX25107 '77-'79 425 RWD DRIVER'S SIDE EXHAUST MANIFOLD

SKU: EX25107

Reconditioned '77-'79 425 RWD Driver's Side Exhaust Manifold

[Read More](#)

Price: \$275.00



EX25106 '77-'79 425 PASSENGER'S SIDE EXHAUST MANIFOLD

SKU: EX25106

Reconditioned '77-'79 425 Passenger's Side (RWD and Eldo)

[Read More](#)

Price: \$325.00



EX25105 '68-'76 ELDORADO DRIVER'S SIDE EXHAUST MANIFOLD

SKU: EX25105

Reconditioned '68-'76 Eldorado Driver's Side Exhaust Manifold

[Read More](#)

Price: \$325.00



EX25104 '68-'72 ELDORADO PASSENGER'S SIDE EXHAUST MANIFOLD

SKU: EX25104

Reconditioned '68-'72 Eldorado Passenger's Side Exhaust Manifold

[Read More](#)

Price: \$325.00

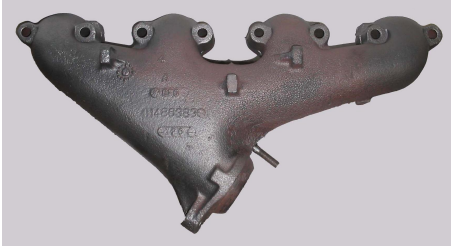

EX25103 '68-'76 RWD DRIVER'S SIDE EXHAUST MANIFOLD

SKU: EX25103

Reconditioned '68-'76 RWD Driver's Side Exhaust Manifold

[Read More](#)

Price: \$250.00



EX25101 '68-'76 RWD AND '73-'76 ELDORADO PASSENGER'S SIDE EXHAUST MANIFOLD (CONE)

SKU: EX25101

Reconditioned '68-'76 RWD and '73-'76 Eldo Passenger's Side
With cone for connecting the exhaust down-pipe directly to the manifold.

[Read More](#)

Price: \$275.00



EX21105 '68-'76 ELDORADO LEFT SIDE MANIFOLD NEW, IMPORTED

SKU: EX21105

'68-'76 Eldorado Left Side Manifold New, imported

[Read More](#)

Price: \$375.00



EX20111 EXHAUST MANIFOLD COLLECTOR STUDS W/ BRASS NUTS

SKU: EX20111

Exhaust Manifold Collector Studs w/ Brass Nuts

Stud and nut kit for exhaust manifolds (for attaching pipes directly to manifolds, without EFE valve). Steel stud with brass nut, 2 each (1 manifold worth) Fits 472 / 500 / 425 manifolds. 368 Manifolds need 1.5 kits per manifold (3 studs).

[Read More](#)

Price: \$12.00



EX20102 EXHAUST MANIFOLD BOLT SET, SHORT (8 BOLT SET) BLACK FLANGE HEAD HEX BOLTS

SKU: EX20102

Short exhaust manifold bolts (1" long bolts), 1/2 set (8 bolts) 2 sets required per engine.

[Read More](#)

Price: \$12.00

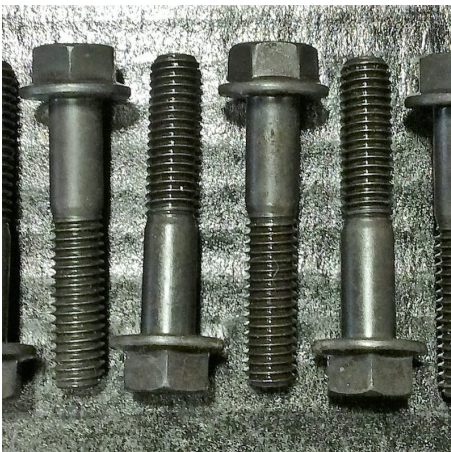

EX20101 EXHAUST MANIFOLD BOLT SET, LONG (8 BOLT SET) BLACK FLANGE HEAD HEX BOLTS

SKU: EX20101

Long exhaust manifold bolts (2" long bolts), 1/2 set (8 bolts) 2 sets required per engine.

[Read More](#)

Price: \$12.00

HEADERS



TS11209 EXHAUST BOLT REMOVAL TOOL KIT

SKU: TS11209

Manibolt Driller tool / fixture kit, makes removing broken bolts a 'snap', often without pulling the heads or engine out of the car.

With this precision tool you can drill and tap broken exhaust manifold bolts dead center and perfectly straight, every time, even if you can't see where you're drilling!

This kit fits all '68-'85 Cadillac 472 / 500 / 425 / 368 Cadillac engines.

Kit includes: Bushing Clamp (Qty 3, sizes 1/8 1/4 and 5/16), Drills and Taps (Qty 1 ea. 1/8 1/4 and 5/16 with 3/8-16 Tap), Knurled Thumbscrew for mounting Bushing Clamps, Modified 3/8-16 Stainless Flatheads (Qty 4), and a Rugged plastic case with laser cut foam fitted for dedicated placement.

For more information, see the detailed info tab.

You can also visit Beydler's website [here](#) for how-to videos and more.

[Read More](#)

Price: \$450.00



GS31131 COMPRESSED GRAPHITE HEADER GASKETS

SKU: GS31131

Compressed Graphite Header Gaskets - 1 Pair



[Read More](#)

Price: \$75.00

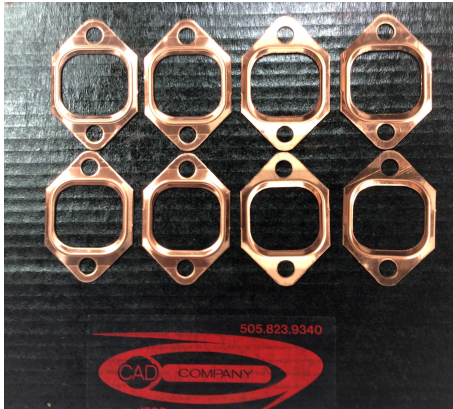

GS31121 SCE COPPER HEADER GASKETS 8 INDIVIDUAL GASKETS

SKU: GS31121

SCE Copper Header Gaskets 8 individual gaskets

[Read More](#)

Price: \$95.00

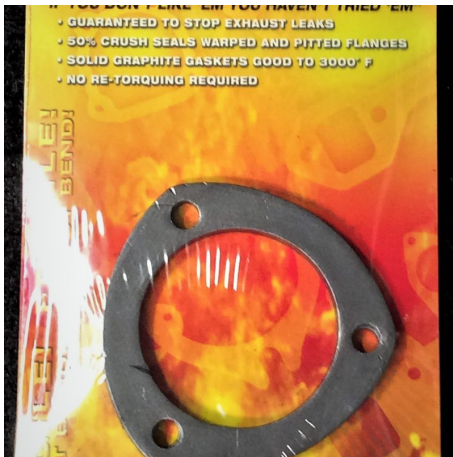

GS30133 REMFLEX COMPRESSED GRAPHITE 3" COLLECTOR GASKETS 1 PR

SKU: GS30133

Compressed Graphite 3" Collector Gaskets 1 pr

[Read More](#)

Price: \$30.00



GS30123 SCE COPPER 3" COLLECTOR GASKETS 1 PR

SKU: GS30123

SCE Copper 3" Collector Gaskets 1 pr

[Read More](#)

Price: \$30.00

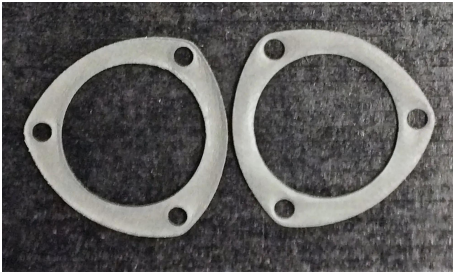

GS30113 COMPOSITE 3" COLLECTOR GASKETS 1 PR

SKU: GS30113

Composite 3" Collector Gaskets 1 pr

[Read More](#)

Price: \$15.00



EX67132 3/8" BOOGIEMAN D-PORT HEADER FLANGES (1 PAIR)

SKU: EX67122-1

3/8" 3-Bolt D-port BoogieMan Header Flange (Pair)

[Read More](#)

Price: \$90.00

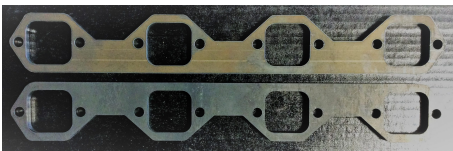

EX67122 3/8" HEADER FLANGES (1 PAIR)

SKU: EX67122

3/8" Header Flange Kit

[Read More](#)

Price: \$90.00

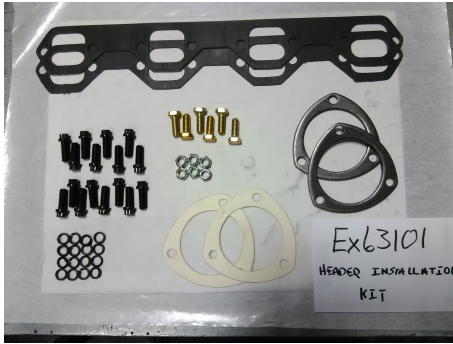

EX63100 HEADER INSTALL KIT

SKU: EX63100

Header installation kit - Includes premium composite header and collector gaskets, 12 point header bolts and lock washers, Collector bolts and lock nuts, and a pair of collector flanges.

Please select composite, copper, or graphite gaskets.

[Read More](#)

Price: \$85.00 - \$165.00



EX41160 '59-'64 CADILLAC HEADERS WITH 472 / 500 / 425 SWAP, 1 3/4"

SKU: EX41160

Mid length headers for '59-'64 Cadillac with 472 / 500 / 425 swap.



Premium mid length header. Fits '59-'64 with 472 / 500 / 425 RWD swaps with little or no mods, may also fit some '54-'58 swaps. CNC Mandrel bent, 3/8 flanges, 3" collector. 1 3/4" primaries.

Note that these use a clamp-on collector (included), rather than the traditional 3-bolt collector, due to space limitations.

[Read More](#)

Price: \$575.00 - \$1,020.00



EX41140 G-BODY HEADERS

SKU: EX41140

G-Body mid length swap headers for 472, 500, and 425 CID Cadillac engines.

Designed to fit '77-'87 G-body cars (RWD Malibu, Monte Carlo, El Camino, Cutlass, Grand Prix, Regal, etc.) with our bolt-in motor mount kit. Fits most cars with no modification necessary. Can be used with our universal motor mount kit or a custom mounting solution, but you will want to have the headers in place to ensure a good fit before finalizing the engine mounting location.

Easy fit, no hammer required - properly designed to fit the applications as designed, and perform great.

[Read More](#)

Price: \$550.00 - \$945.00



EX41130 UNIVERSAL REAR-EXIT HEADERS

SKU: EX41130

'77-up RWD Cadillac with a 472, 500, or 425 CID Cadillac engine.

[Read More](#)

Price: \$550.00 - \$990.00



EX41120 '68-'78 ELDORADO HEADERS

SKU: EX41120

Mid length headers for '68-'78 Eldorado

Specifically designed for the big body Eldo.

Easy fit, no hammer required - properly designed to fit the application and perform great.

These headers can also be used in '67 Eldos and '79-'85 Eldos and Seviles with a 472, 500, or 425 CID swap, but may require minor modification. These headers do *not* fit in the FWD GMC motorhome swap.

[Read More](#)

Price: \$550.00 - \$990.00



EX41110 '68-'76 RWD CADILLAC HEADERS

SKU: EX41110

Mid length headers for '68-'76 RWD Cadillac (All exc. Seville). Specifically designed for '67-'76 Coupe Deville, Sedan Deville, Concourse, Calais, and Fleetwood cars.

Can also be used in '64-'67 RWD Cadillacs with a 472, 500, or 425 CID swap, but often requires minor modification. Also used for most RWD / rear-steer swaps, such as '72-older Fords, some 50s Oldsmobiles, etc.

Easy fit, no hammer required - properly designed to fit the application and perform great.

[Read More](#)

Price: \$550.00 - \$990.00



EX41100 BLOCK HUGGERS STREET ROD STYLE, CENTER EXIT

SKU: EX41100

Block Hugger Headers

These are the classic street rod header. The collector is in the center of the engine, pointing straight down.

[Read More](#)

Price: \$395.00 - \$790.00





EX40101 HEADER BOLT SET (12 POINT BLACK OXIDE BOLTS)

SKU: EX40101

Header Bolt Set 16-12 point black oxide bolts

[Read More](#)

Price: \$25.00

GASKETS



VT37012 VITON UMBRELLA VALVE STEM SEALS

SKU: VT37012

Viton Umbrella Valve Stem Seals

[Read More](#)

Price: \$20.00



PB11113 CRANK HUB SLEEVE

SKU: PB11113

Crank hub sealing surface repair sleeve.

[Read More](#)

Price: \$95.00



GS80301 RIGHT STUFF™ GASKET MAKER

SKU: GS80301

Right Stuff™ Gasket Maker

[Read More](#)

Price: \$60.00



GS80102 BRUSH ON GASKET SEALER

SKU: GS80102

Permatex Brush On Gasket Sealer

[Read More](#)

Price: \$30.00

GS80101 BRUSH ON GASKET SEALER *DISCONTINUED***

SKU: GS80101

GM Brush On Gasket Sealer

[Read More](#)

Price: \$25.00



GS71201 COMPLETE ENGINE BUILDER GASKET SET WITHOUT HEAD GASKETS '68- '76

SKU: GS71201

Complete Engine Builder Gasket Set Without Head Gaskets

'68-'76 472/500 CID, Does not include intake gasket or head gaskets.

[Read More](#)

Price: \$193.27

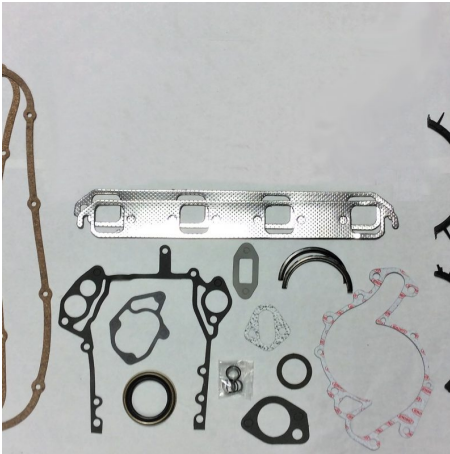

GS71112 COMPLETE ENGINE BUILDER GASKET SET '77-'79

SKU: GS71112

Complete Engine Builder Gasket Set

'77-'79

[Read More](#)

Price: \$214.06

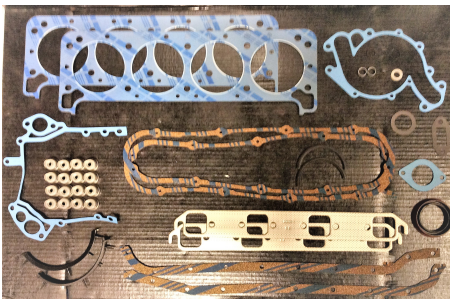

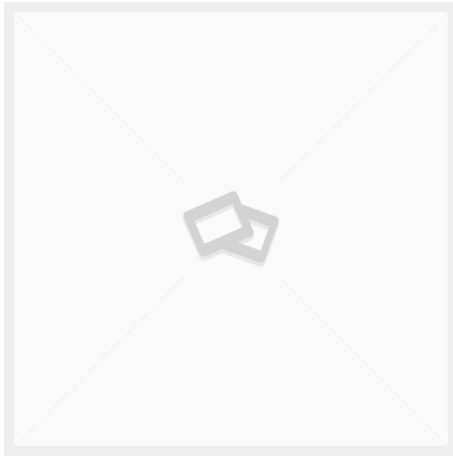

GS71102 FEL-PRO / SEALED POWER COMPLETE ENGINE BUILDER GASKET SET '68-'76

SKU: GS71102

Fel-Pro / Sealed Power Complete Engine Builder Gasket Set

'68-'76 472/500 CID, Does not include intake gasket or oil pump gasket, may not include rear main seal.

Note: All 472 / 500 / 425 / 368 kits include neoprene 2-piece rear main seals.

We neither sell nor recommend rope rear main seals for Cadillac engines originally designed for neoprene.

Warning: Some Fel-Pro / Sealed Power gasket sets come with a rope seal instead of a neoprene seal! We do not have any control over that - these sets are sold 'as packaged' by Sealed Power.

[Read More](#)

Price: \$223.70

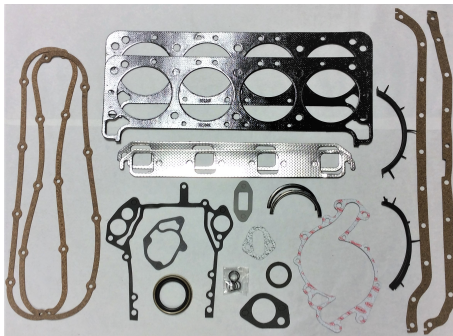

GS71101 COMPLETE ENGINE BUILDER GASKET SET '68-'76

SKU: GS71101

Premium Complete Engine Builder's Gasket Set

'68-'76

[Read More](#)

Price: \$240.37



GS61101 EGR VALVE GASKET

SKU: GS61101

[Read More](#)

Price: \$3.00

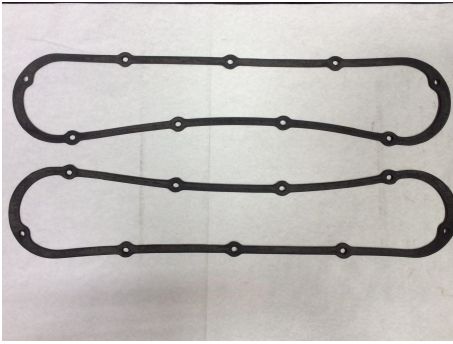

GS51701 VALVE COVER GASKET - NEOPRENE

SKU: GS51701

Neoprene Valve Cover Gasket

[Read More](#)

Price: \$30.00

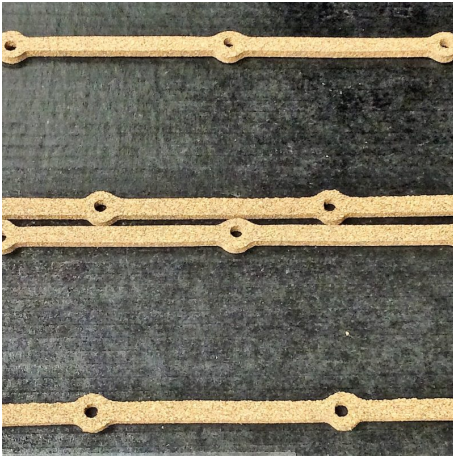

GS51612 CAD COMPANY 2X VALVE COVER GASKETS

SKU: GS51612

**Cad Company 2X valve cover gaskets
Double thick nylon impregnated cork**

[Read More](#)

Price: \$40.00

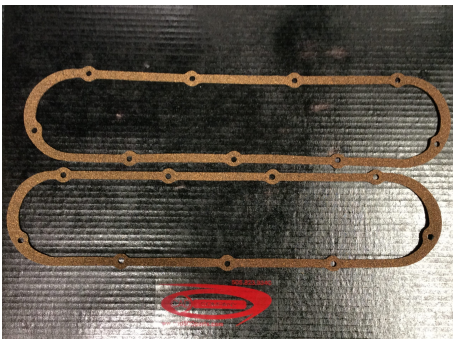

GS51601 VALVE COVER GASKET - CORK

SKU: GS51601

Cork Valve Cover Gasket

[Read More](#)

Price: \$15.00



GS51204 SCE™ STANDARD COPPER HEAD GASKETS (PR.)

SKU: GS51204

SCE™ Standard Copper Head Gaskets

Sold in pairs.

[Read More](#)

Price: \$195.00



GS51201 SCE TITAN COPPER HEAD GASKETS (PR.)

SKU: GS51201

SCE Titan Copper Head Gaskets

Sold in pairs.

[Read More](#)

Price: \$265.00



GS51111 FEL-PRO™ (BLUE) 425 CID OE REPLACEMENT HEAD GASKETS (EA.)

SKU: GS51101-1

Fel-Pro™ (Blue) OE Replacement Head Gaskets for 425 CID Cadillac engines

Sold individually.

[Read More](#)

Price: \$30.00

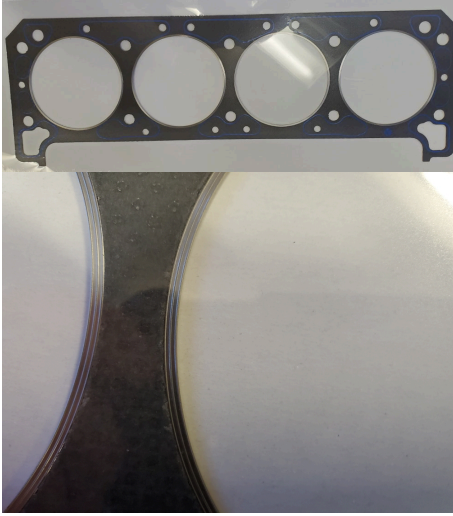

GS511056 CUT RING HEAD GASKET FOR 472 / 500

SKU: GS51105.6

472 / 500 Cadillac Cut Ring Head Gasket

Cut ring head gasket for bore sizes up to 4.360" (.060" over) or 4.420" (.120" over). Choose a size when ordering.

These are the best sealing available for high cylinder pressure applications.

[Read More](#)

Price: \$175.00

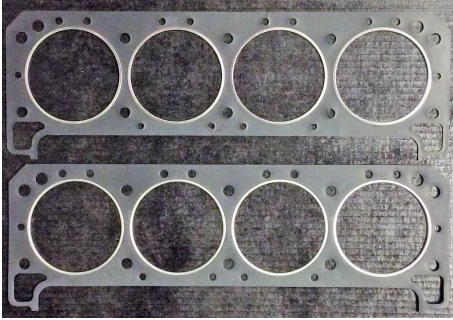

GS51104 CAD COMPANY™ PROCAD™ 472 / 500 CID HIGH PERFORMANCE / BIG-BORE HEAD GASKETS (EA.)

SKU: GS51104

Cad Company™ ProCad™ High Performance / Big-Bore Head Gaskets (Black) for 472 / 500 CID Cadillac engines.

Sold individually

[Read More](#)

Price: \$70.00

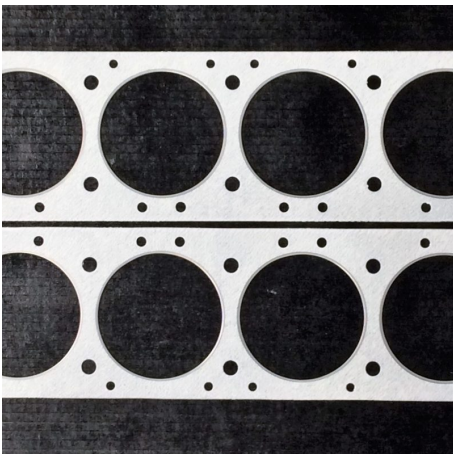

GS51102 CAD COMPANY™ 472 / 500 CID PERFORMANCE HEAD GASKETS (EA.)

SKU: GS51102

Cad Company™ Performance Head Gaskets (White or Black) for 472 / 500 CID Cadillac engines.

Sold individually.

[Read More](#)

Price: \$39.00



GS51101 FEL-PRO™ (BLUE) 472 / 500 CID OE REPLACEMENT HEAD GASKETS (EA.)

SKU: GS51101

**Fel-Pro™ (Blue) OE Replacement Head Gaskets for 472 / 500 CID
Cadillac engines.**

Sold individually.

[Read More](#)

Price: \$30.00

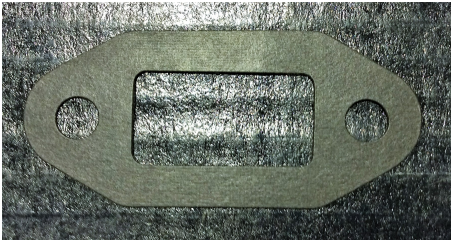

GS41701 FUEL PUMP GASKET

SKU: GS41701

Fuel Pump Gasket

[Read More](#)

Price: \$5.00



GS41603 THERMOSTAT GASKET - OE STYLE

SKU: GS41603

Thermostat Gasket - OE Style

[Read More](#)

Price: \$2.50



GS41602 STATITE™ THERMOSTAT GASKET

SKU: GS41602

StaTite™ Thermostat Gasket

[Read More](#)

Price: \$2.75



GS41402 TIMING COVER GASKET FOR 472 / 500

SKU: GS41402

472 / 500 Cadillac Timing Cover Gasket

[Read More](#)

Price: \$10.00

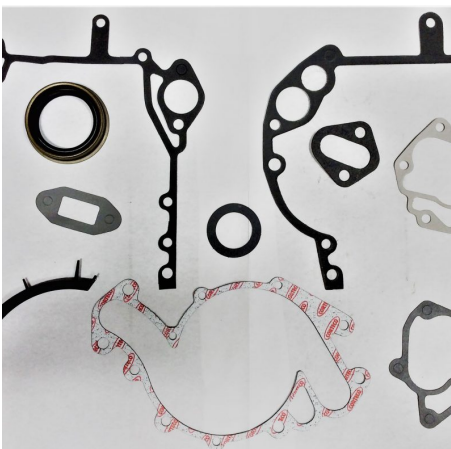

GS41401 TIMING COVER GASKET SET

SKU: GS41401

Timing Cover Gasket Set

[Read More](#)

Price: \$35.00



GS41301 NEOPRENE 2 PC. REAR MAIN SEAL

SKU: GS41301

Neoprene 2 piece Rear Main Seal

[Read More](#)

Price: \$30.00

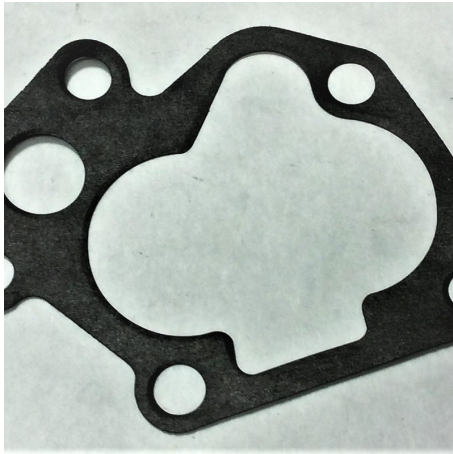

GS41201 OIL PUMP GASKET

SKU: GS41201

Oil Pump Gasket

[Read More](#)

Price: \$5.00

GS41102 CAD COMPANY OILPAN GASKET SET

SKU: GS41102

Oil Pan Gasket Set - with cork side gaskets and RTV for the end seals.



[Read More](#)

Price: \$30.00



GS41101 OIL PAN GASKET SET

SKU: GS41101

Oil Pan Gasket Set

[Read More](#)

Price: \$30.00



GS31131 COMPRESSED GRAPHITE HEADER GASKETS

SKU: GS31131

Compressed Graphite Header Gaskets - 1 Pair



**MADE IN
THE U.S.A.**



[Read More](#)

Price: \$75.00

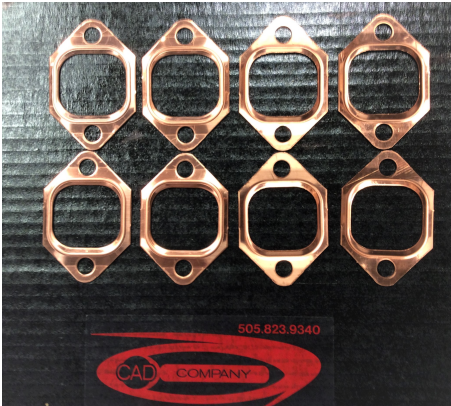

GS31121 SCE COPPER HEADER GASKETS 8 INDIVIDUAL GASKETS

SKU: GS31121

SCE Copper Header Gaskets 8 individual gaskets

[Read More](#)

Price: \$95.00



GS31112 CAD COMPANY BOOGIEMAN™ COMPOSITE HEADER GASKETS

SKU: GS31112

Cad Company BoogieMan™ Composite Header Gaskets



[Read More](#)

Price: \$35.00



GS31111 CAD COMPANY COMPOSITE HEADER GASKETS

SKU: GS31111

Cad Company Composite Header Gaskets

[Read More](#)

Price: \$25.00



GS31101 EXHAUST MANIFOLD GASKETS

SKU: GS31101

Stock Replacement Exhaust Manifold Gaskets

[Read More](#)

Price: \$20.00

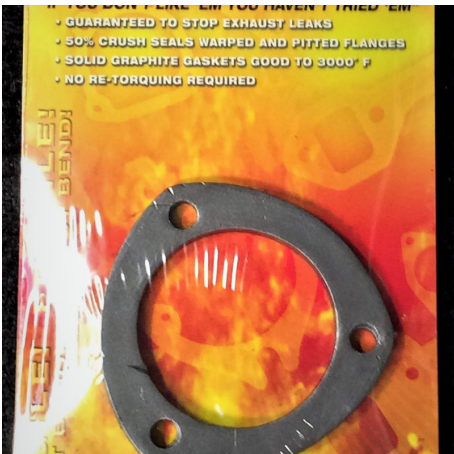

GS30133 REMFLEX COMPRESSED GRAPHITE 3" COLLECTOR GASKETS 1 PR

SKU: GS30133

Compressed Graphite 3" Collector Gaskets 1 pr

[Read More](#)

Price: \$30.00

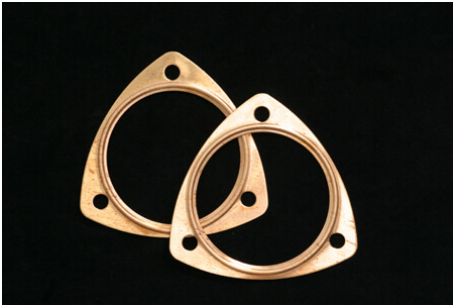

GS30125 SCE™ COPPER COLLECTOR GASKETS 3.5"

SKU: GS30125

SCE™ Copper Collector Gaskets 3.5" (1 pair)

[Read More](#)

Price: \$35.00



GS30123 SCE COPPER 3" COLLECTOR GASKETS 1 PR

SKU: GS30123

SCE Copper 3" Collector Gaskets 1 pr

[Read More](#)

Price: \$30.00



GS30122 SCE™ COPPER COLLECTOR GASKETS 2.5"

SKU: GS30122

SCE™ Copper Collector Gaskets 2.5" (1 pair)

[Read More](#)

Price: \$25.00

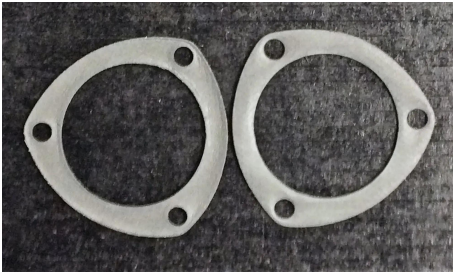

GS30113 COMPOSITE 3" COLLECTOR GASKETS 1 PR

SKU: GS30113

Composite 3" Collector Gaskets 1 pr

[Read More](#)

Price: \$15.00

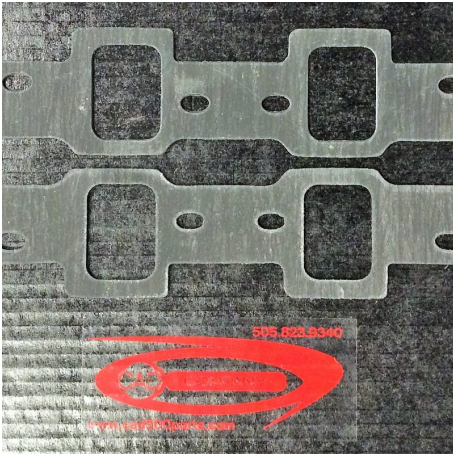

GS21122 BOOGIEMAN™ COMPOSITE INTAKE GASKETS

SKU: GS21122



BoogieMan™ Composite Intake Gaskets

Recommended for use with wide-port BoogieMan™ heads and / or intakes.

Won't come apart when wet.

High quality composite gasket material. Safe for aluminum heads and intakes.

Color may vary.

For iron heads or non-BoogieMan aluminum heads, order [GS21112](#)

Made in USA

[Read More](#)

Price: \$35.00

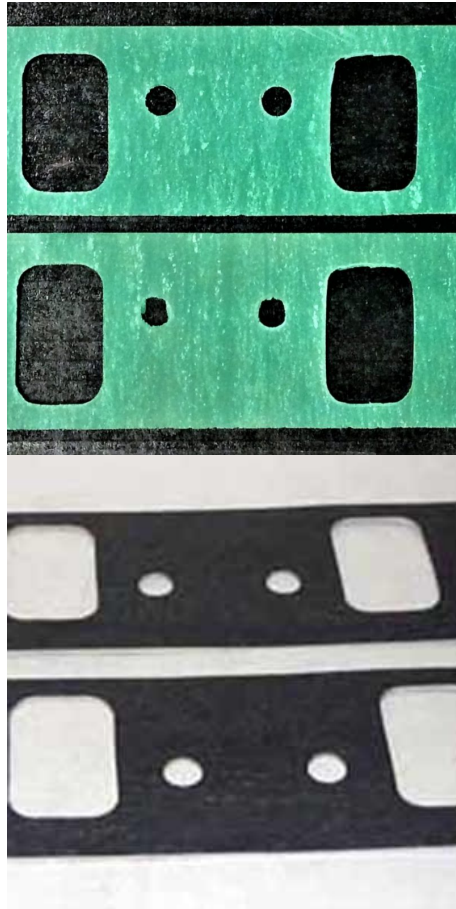

GS21112 CAD COMPANY COMPOSITE INTAKE GASKETS

SKU: GS21112

Cad Company Composite Intake Gaskets

For use with heads with the standard intake port configuration (factory heads, ported or not, and most non-BoogieMan aluminum heads).

Blocks exhaust crossover through intake (can be trimmed to allow crossover flow if needed).

Won't burn through at crossover or come apart when wet.

High quality composite gasket material. Safe (and recommended for) for aluminum heads and intakes.

Color may vary.

Made in USA

[Read More](#)

Price: \$28.00

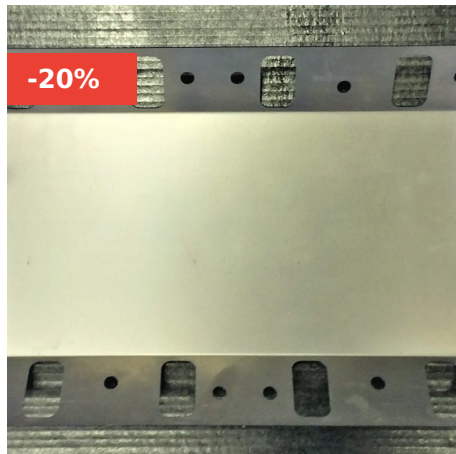

GS21102 HEAVY-DUTY LASER CUT STEEL VALLEY PAN

SKU: GS21102

Heavy-Duty Laser Cut Steel Valley Pan

[Read More](#)

Price: ~~\$50.00~~ \$40.00



GS21101 STEEL (OE STYLE) VALLEY PAN INTAKE GASKET

SKU: GS21101

Steel (OE Style) Valley Pan Intake Gasket

[Read More](#)

Price: \$55.00

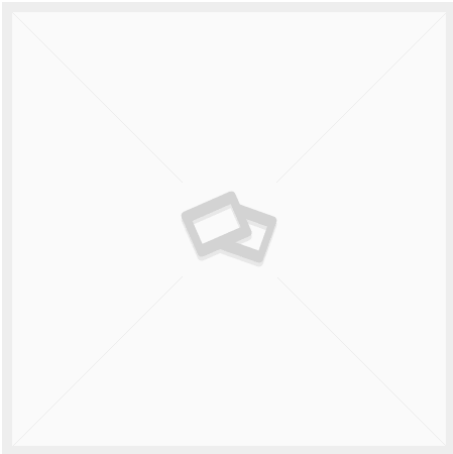

GS10213 CARB GASKET, 1/4" THICK '70-'84

SKU: GS10213

Carb Gasket '70-'84 Q-jet w/o exhaust at carb base

1/4" thick insulator style.

[Read More](#)

Price: \$8.00

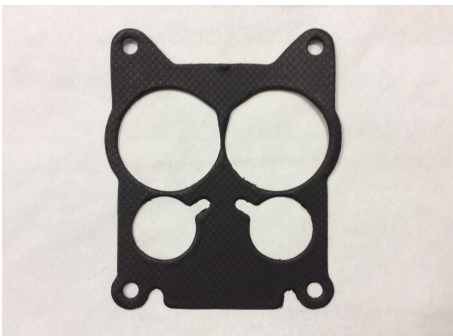

GS10212 CARB GASKET '70-'84

SKU: GS10212

Carb Gasket '70-'84

[Read More](#)

Price: \$8.00

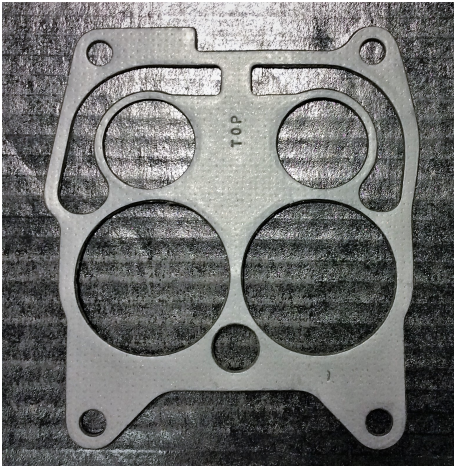

GS10211 CARB GASKET '67-'70

SKU: GS10211

Carb Gasket '67-'70

[Read More](#)

Price: \$8.00

ENGINE GASKET SETS

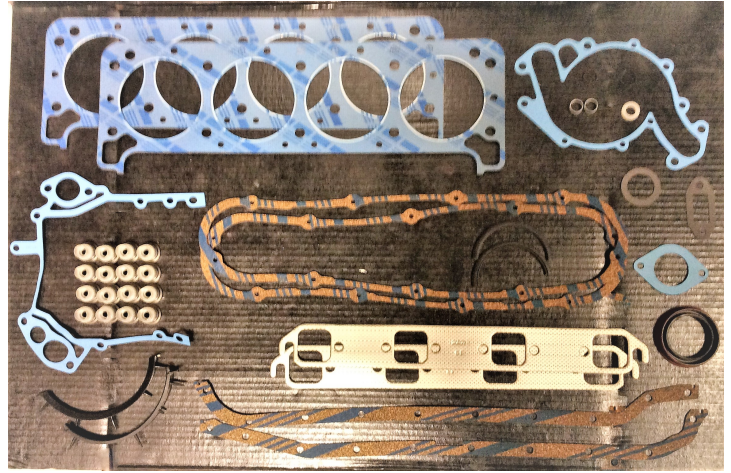

GS71201 COMPLETE ENGINE BUILDER GASKET SET WITHOUT HEAD GASKETS '68-'76

SKU: GS71201

Complete Engine Builder Gasket Set Without Head Gaskets
'68-'76 472/500 CID, Does not include intake gasket or head gaskets.

[Read More](#)

Price: \$193.27

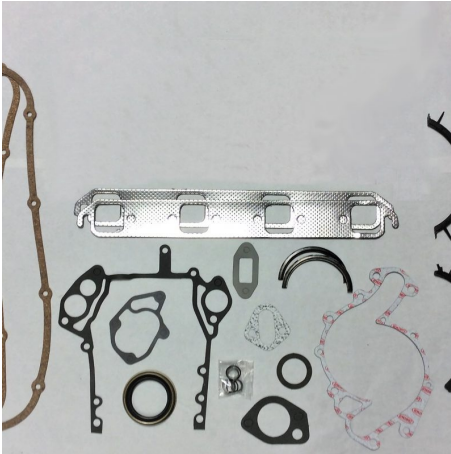

GS71112 COMPLETE ENGINE BUILDER GASKET SET '77-'79

SKU: GS71112

Complete Engine Builder Gasket Set
'77-'79

[Read More](#)

Price: \$214.06

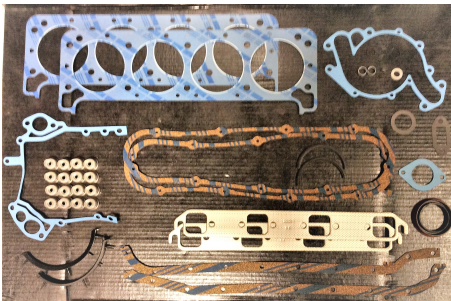

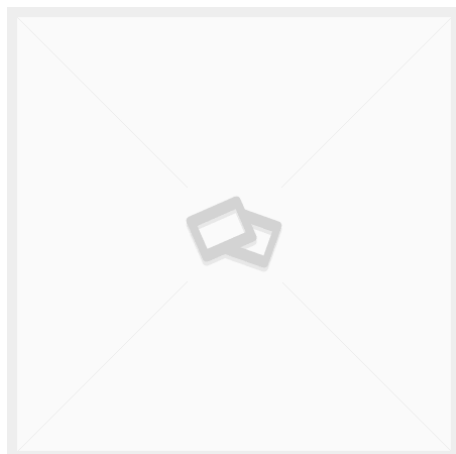

GS71102 FEL-PRO / SEALED POWER COMPLETE ENGINE BUILDER GASKET SET '68-'76

SKU: GS71102

Fel-Pro / Sealed Power Complete Engine Builder Gasket Set

'68-'76 472/500 CID, Does not include intake gasket or oil pump gasket, may not include rear main seal.

Note: All 472 / 500 / 425 / 368 kits include neoprene 2-piece rear main seals.

We neither sell nor recommend rope rear main seals for Cadillac engines originally designed for neoprene.

Warning: Some Fel-Pro / Sealed Power gasket sets come with a rope seal instead of a neoprene seal! We do not have any control over that - these sets are sold 'as packaged' by Sealed Power.

[Read More](#)

Price: \$223.70

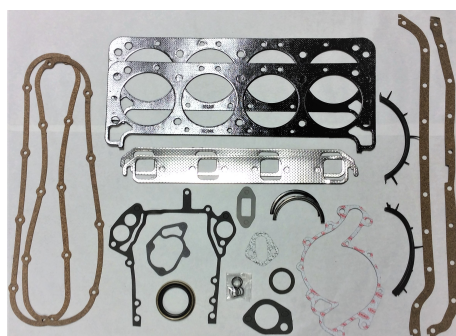

GS71101 COMPLETE ENGINE BUILDER GASKET SET '68-'76

SKU: GS71101

Premium Complete Engine Builder's Gasket Set

'68-'76

[Read More](#)

Price: \$240.37



GS61101 EGR VALVE GASKET

SKU: GS61101

[Read More](#)

Price: \$3.00

HEAD GASKETS



GS51204 SCE™ STANDARD COPPER HEAD GASKETS (PR.)

SKU: GS51204

SCE™ Standard Copper Head Gaskets

Sold in pairs.

[Read More](#)

Price: \$195.00



GS51201 SCE TITAN COPPER HEAD GASKETS (PR)

SKU: GS51201

SCE Titan Copper Head Gaskets

Sold in pairs.

[Read More](#)

Price: \$265.00



GS51111 FEL-PRO™ (BLUE) 425 CID OE REPLACEMENT HEAD GASKETS (EA.)

SKU: GS51101-1

Fel-Pro™ (Blue) OE Replacement Head Gaskets for 425 CID Cadillac engines

Sold individually.

[Read More](#)

Price: \$30.00

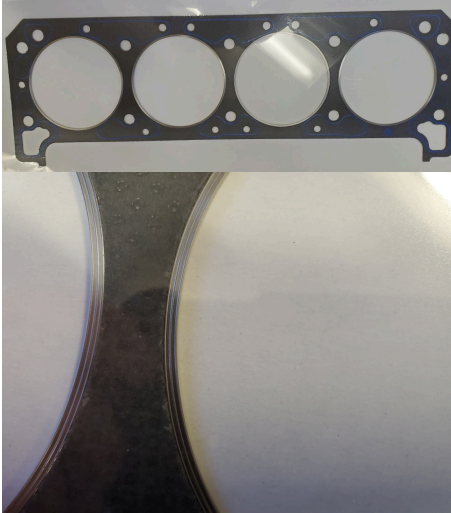

GS511056 CUT RING HEAD GASKET FOR 472 / 500

SKU: GS51105.6

472 / 500 Cadillac Cut Ring Head Gasket

Cut ring head gasket for bore sizes up to 4.360" (.060" over) or 4.420" (.120" over). Choose a size when ordering.

These are the best sealing available for high cylinder pressure applications.

[Read More](#)

Price: \$175.00

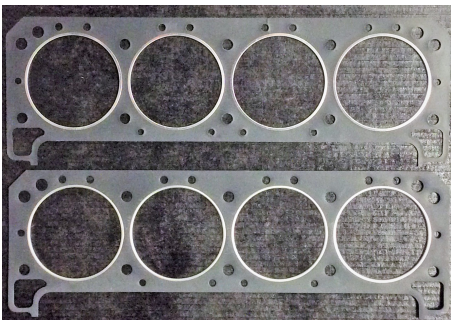

GS51104 CAD COMPANY™ PROCAD™ 472 / 500 CID HIGH PERFORMANCE / BIG-BORE HEAD GASKETS (EA.)

SKU: GS51104

Cad Company™ ProCad™ High Performance / Big-Bore Head Gaskets (Black) for 472 / 500 CID Cadillac engines.

Sold individually

[Read More](#)

Price: \$70.00

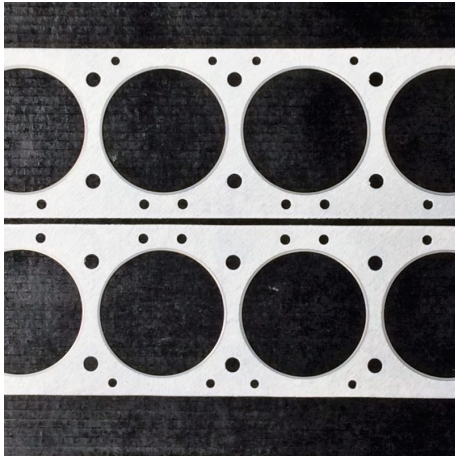

GS51102 CAD COMPANY™ 472 / 500 CID PERFORMANCE HEAD GASKETS (EA.)

SKU: GS51102

Cad Company™ Performance Head Gaskets (White or Black) for 472 / 500 CID Cadillac engines.

Sold individually.

[Read More](#)

Price: \$39.00



GS51101 FEL-PRO™ (BLUE) 472 / 500 CID OE REPLACEMENT HEAD GASKETS (EA.)

SKU: GS51101

Fel-Pro™ (Blue) OE Replacement Head Gaskets for 472 / 500 CID Cadillac engines.

Sold individually.

[Read More](#)

Price: \$30.00

LOWER ENGINE GASKETS

Lower Engine Gaskets

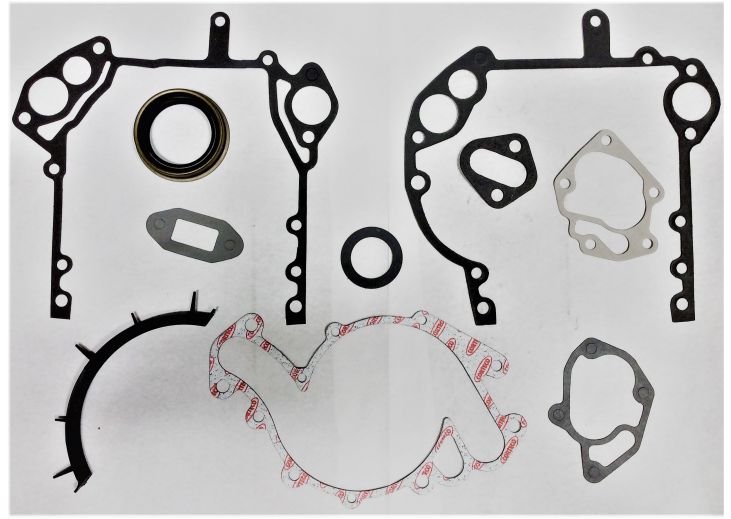

PB11113 CRANK HUB SLEEVE

SKU: PB11113

Crank hub sealing surface repair sleeve.

[Read More](#)

Price: \$95.00

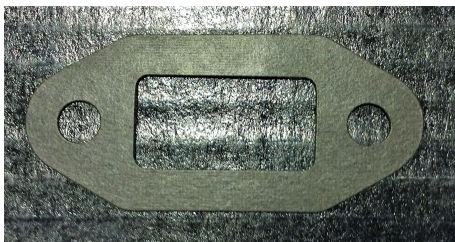

GS41701 FUEL PUMP GASKET

SKU: GS41701

Fuel Pump Gasket

[Read More](#)

Price: \$5.00



GS41402 TIMING COVER GASKET FOR 472 / 500

SKU: GS41402

472 / 500 Cadillac Timing Cover Gasket

[Read More](#)

Price: \$10.00

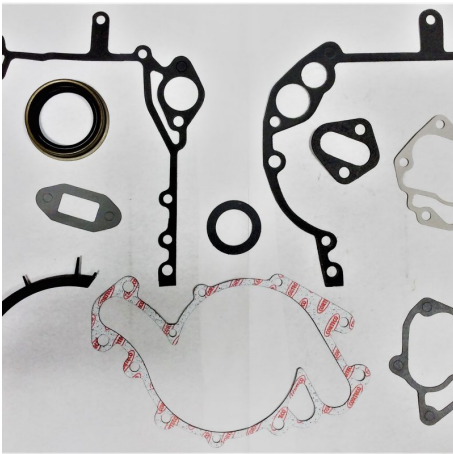

GS41401 TIMING COVER GASKET SET

SKU: GS41401

Timing Cover Gasket Set

[Read More](#)

Price: \$35.00



GS41301 NEOPRENE 2 PC. REAR MAIN SEAL

SKU: GS41301

Neoprene 2 piece Rear Main Seal

[Read More](#)

Price: \$30.00



GS41201 OIL PUMP GASKET

SKU: GS41201

Oil Pump Gasket

[Read More](#)

Price: \$5.00



GS41102 CAD COMPANY OILPAN GASKET SET

SKU: GS41102

Oil Pan Gasket Set - with cork side gaskets and RTV for the end seals.



[Read More](#)

Price: \$30.00



GS41101 OIL PAN GASKET SET

SKU: GS41101

Oil Pan Gasket Set

[Read More](#)

Price: \$30.00

SEALANTS

Sealants



GS80301 RIGHT STUFF™ GASKET MAKER

SKU: GS80301

Right Stuff™ Gasket Maker

[Read More](#)

Price: \$60.00





GS80102 BRUSH ON GASKET SEALER

SKU: GS80102

Permatex Brush On Gasket Sealer

[Read More](#)

Price: \$30.00



GS80101 BRUSH ON GASKET SEALER *DISCONTINUED***

SKU: GS80101

GM Brush On Gasket Sealer

[Read More](#)

Price: \$25.00

UPPER ENGINE GASKETS



VT37012 VITON UMBRELLA VALVE STEM SEALS

SKU: VT37012

Viton Umbrella Valve Stem Seals

[Read More](#)

Price: \$20.00

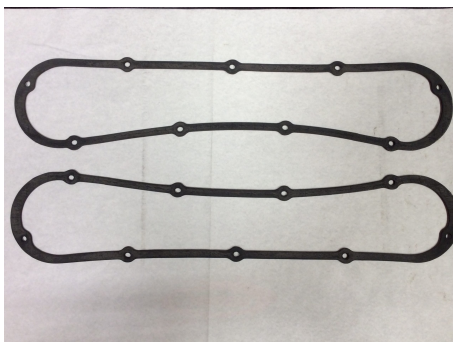

GS51701 VALVE COVER GASKET - NEOPRENE

SKU: GS51701

Neoprene Valve Cover Gasket

[Read More](#)

Price: \$30.00

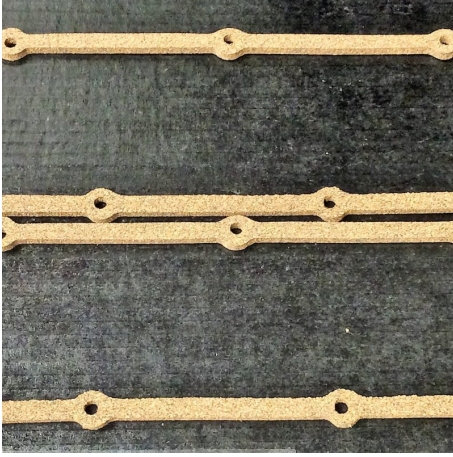

GS51612 CAD COMPANY 2X VALVE COVER GASKETS

SKU: GS51612

**Cad Company 2X valve cover gaskets
Double thick nylon impregnated cork**

[Read More](#)

Price: \$40.00

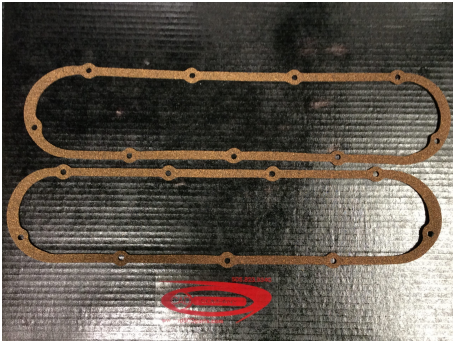

GS51601 VALVE COVER GASKET - CORK

SKU: GS51601

Cork Valve Cover Gasket

[Read More](#)

Price: \$15.00



GS41603 THERMOSTAT GASKET - OE STYLE

SKU: GS41603

Thermostat Gasket - OE Style

[Read More](#)

Price: \$2.50



GS41602 STATITE™ THERMOSTAT GASKET

SKU: GS41602

StaTite™ Thermostat Gasket

[Read More](#)

Price: \$2.75



GS31131 COMPRESSED GRAPHITE HEADER GASKETS

SKU: GS31131

Compressed Graphite Header Gaskets - 1 Pair



**MADE IN
THE U.S.A.**



[Read More](#)

Price: \$75.00

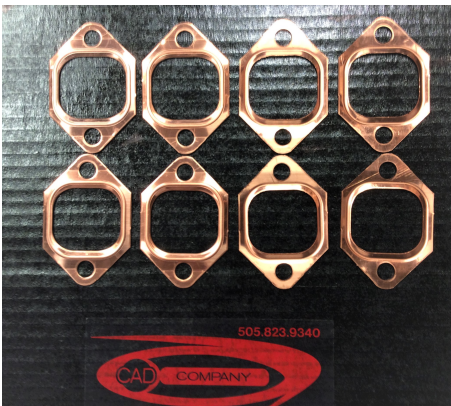

GS31121 SCE COPPER HEADER GASKETS 8 INDIVIDUAL GASKETS

SKU: GS31121

SCE Copper Header Gaskets 8 individual gaskets

[Read More](#)

Price: \$95.00



GS31112 CAD COMPANY BOOGIEMAN™ COMPOSITE HEADER GASKETS

SKU: GS31112

Cad Company BoogieMan™ Composite Header Gaskets



[Read More](#)

Price: \$35.00



GS31111 CAD COMPANY COMPOSITE HEADER GASKETS

SKU: GS31111

Cad Company Composite Header Gaskets

[Read More](#)

Price: \$25.00



GS31101 EXHAUST MANIFOLD GASKETS

SKU: GS31101

Stock Replacement Exhaust Manifold Gaskets

[Read More](#)

Price: \$20.00



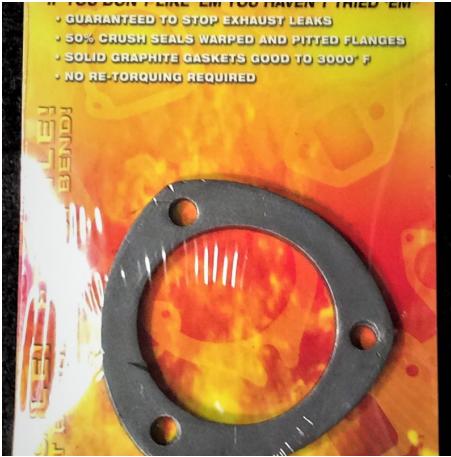

GS30133 REMFLEX COMPRESSED GRAPHITE 3" COLLECTOR GASKETS 1 PR

SKU: GS30133

Compressed Graphite 3" Collector Gaskets 1 pr

[Read More](#)

Price: \$30.00



GS30125 SCE™ COPPER COLLECTOR GASKETS 3.5"

SKU: GS30125

SCE™ Copper Collector Gaskets 3.5" (1 pair)

[Read More](#)

Price: \$35.00



GS30123 SCE COPPER 3" COLLECTOR GASKETS 1 PR

SKU: GS30123

SCE Copper 3" Collector Gaskets 1 pr

[Read More](#)

Price: \$30.00

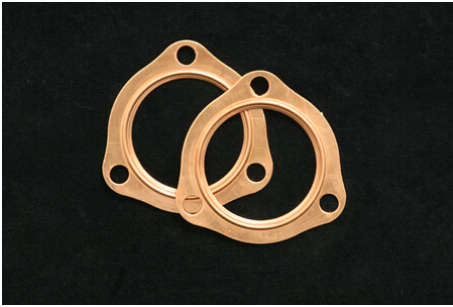

GS30122 SCE™ COPPER COLLECTOR GASKETS 2.5"

SKU: GS30122

SCE™ Copper Collector Gaskets 2.5" (1 pair)

[Read More](#)

Price: \$25.00



GS30113 COMPOSITE 3" COLLECTOR GASKETS 1 PR

SKU: GS30113

Composite 3" Collector Gaskets 1 pr

[Read More](#)

Price: \$15.00

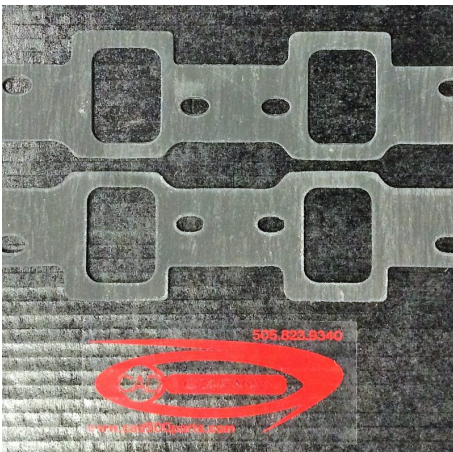

GS21122 BOOGIEMAN™ COMPOSITE INTAKE GASKETS

SKU: GS21122



BoogieMan™ Composite Intake Gaskets

Recommended for use with wide-port BoogieMan™ heads and / or intakes.

Won't come apart when wet.

High quality composite gasket material. Safe for aluminum heads and intakes.

Color may vary.

For iron heads or non-BoogieMan aluminum heads, order [GS21112](#)



Made in USA

[Read More](#)

Price: \$35.00

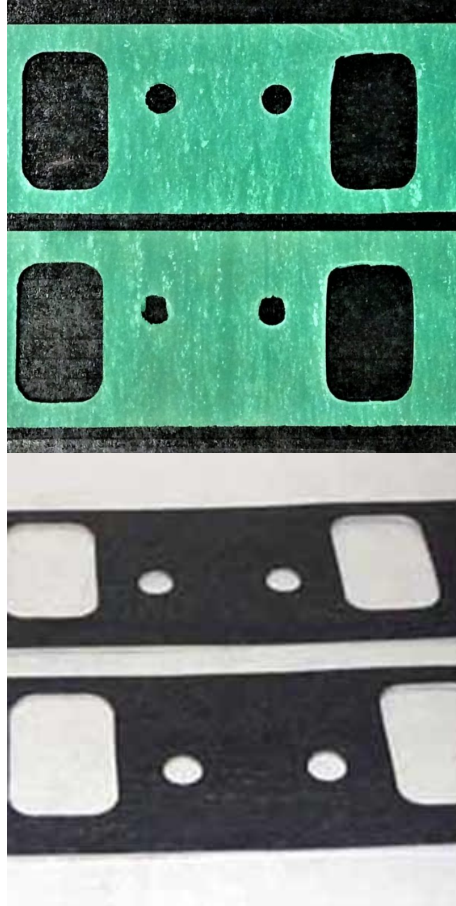

GS21112 CAD COMPANY COMPOSITE INTAKE GASKETS

SKU: GS21112

Cad Company Composite Intake Gaskets

For use with heads with the standard intake port configuration (factory heads, ported or not, and most non-BoogieMan aluminum heads).

Blocks exhaust crossover through intake (can be trimmed to allow crossover flow if needed).

Won't burn through at crossover or come apart when wet.

High quality composite gasket material. Safe (and recommended for) for aluminum heads and intakes.

Color may vary.

Made in USA

[Read More](#)

Price: \$28.00

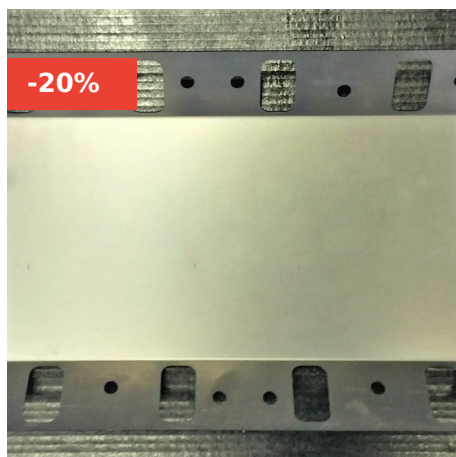

GS21102 HEAVY-DUTY LASER CUT STEEL VALLEY PAN

SKU: GS21102

Heavy-Duty Laser Cut Steel Valley Pan

[Read More](#)

Price: ~~\$50.00~~ \$40.00



GS21101 STEEL (OE STYLE) VALLEY PAN INTAKE GASKET

SKU: GS21101

Steel (OE Style) Valley Pan Intake Gasket

[Read More](#)

Price: \$55.00

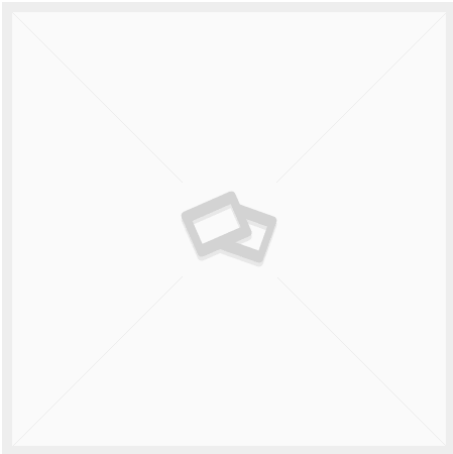

GS10213 CARB GASKET, 1/4" THICK '70-'84

SKU: GS10213

Carb Gasket '70-'84 Q-jet w/o exhaust at carb base

1/4" thick insulator style.

[Read More](#)

Price: \$8.00

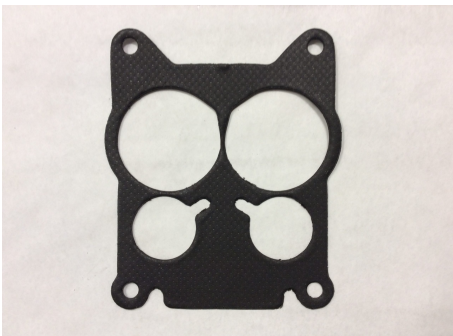

GS10212 CARB GASKET '70-'84

SKU: GS10212

Carb Gasket '70-'84

[Read More](#)

Price: \$8.00

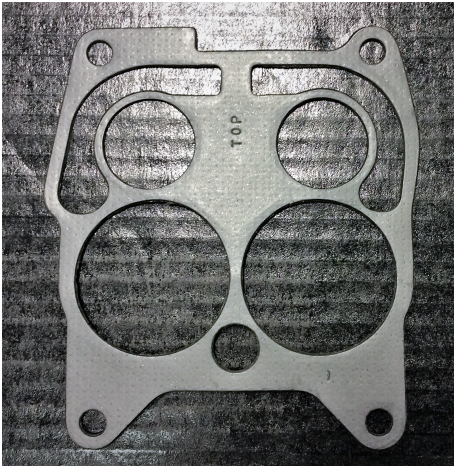

GS10211 CARB GASKET '67-'70

SKU: GS10211

Carb Gasket '67-'70

[Read More](#)

Price: \$8.00

HARDWARE AND FASTENERS



VT15111 CAM GEAR BOLTS ARP (SHALLOW HEAD)

SKU: VT15111

Cam Gear Bolts ARP shallow head

[Read More](#)

Price: \$10.00



VT10102 TIMING COVER/WATER PUMP BOLT KIT STAINLESS SOCKET HEAD

SKU: VT10102

Timing Cover/Water Pump Bolt Kit Stainless Socket Head

[Read More](#)

Price: \$35.00



TS11209 EXHAUST BOLT REMOVAL TOOL KIT

SKU: TS11209

Manibolt Driller tool / fixture kit, makes removing broken bolts a 'snap', often without pulling the heads or engine out of the car.

With this precision tool you can drill and tap broken exhaust manifold bolts dead center and perfectly straight, every time, even if you can't see where you're drilling!

This kit fits all '68-'85 Cadillac 472 / 500 / 425 / 368 Cadillac engines.

Kit includes: Bushing Clamp (Qty 3, sizes 1/8 1/4 and 5/16), Drills and Taps (Qty 1 ea. 1/8 1/4 and 5/16 with 3/8-16 Tap), Knurled Thumbscrew for mounting Bushing Clamps, Modified 3/8-16 Stainless Flatheads (Qty 4), and a Rugged plastic case with laser cut foam fitted for dedicated placement.

For more information, see the detailed info tab.

You can also visit Beydler's website [here](#) for how-to videos and more.

[Read More](#)

Price: \$450.00

RB40111 CRANK KEY

SKU: RB40111

Crankshaft key for timing gear / crank hub for Cadillac 472 / 500 / 425 / 368 engines. The correct factory style key. Nothing special, just the right thing.

[Read More](#)

Price: \$6.00



RB30121 ROD BOLTS ARP CHROMOLY W/ NUTS

SKU: RB30121

Rod Bolts ARP Chromoly with nuts

[Read More](#)

Price: \$95.00



RB10132 LONG MAIN STUD KIT ARP 4130 CHROMOLY (W/ NUTS AND WASHERS)

SKU: RB10132

for use with main girdle

[Read More](#)

Price: \$175.00



RB10131 MAIN STUD KIT ARP 4130 CHROMOLY - (W/ NUTS AND WASHERS)

SKU: RB10131

Main Stud Kit ARP 4130 Chromoly with nuts and washers

[Read More](#)

Price: \$145.00

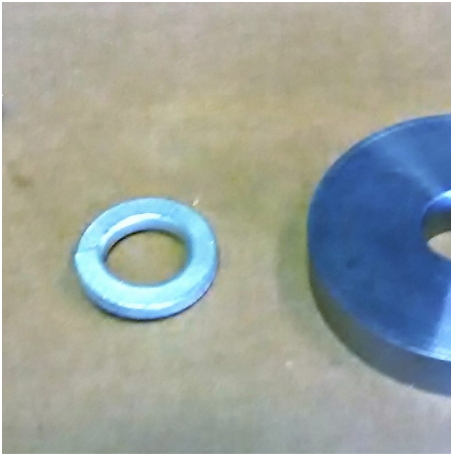

PB11122 CRANK HUB BOLT AND WASHER KIT

SKU: PB11122

Crank Hub Bolt and Washer Kit Correct washer to clear the pulley. Fits the front of the crankshaft, to positively retain the crank hub or damper (or dampener or balancer, as some folks call them).

[Read More](#)

Price: \$15.00

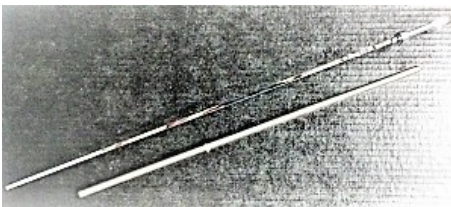

OS40220 DIPSTICK TUBE POLISHED STAINLESS STEEL W/ CHROME DIPSTICK

SKU: OS40220

Dipstick Tube Polished stainless steel with chrome dipstick

[Read More](#)

Price: \$75.00

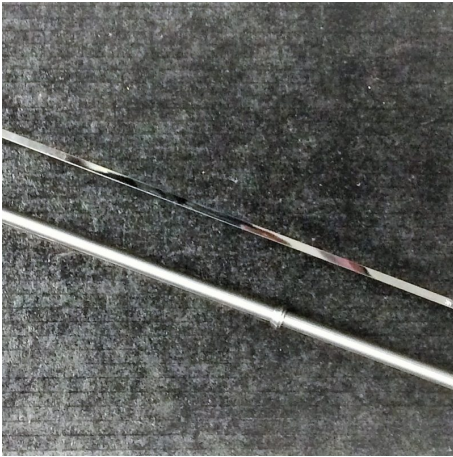

OS40210 DIPSTICK TUBE STAINLESS STEEL W/ CHROME DIPSTICK

SKU: OS40210

Dipstick Tube Stainless steel with chrome dipstick

[Read More](#)

Price: \$49.00

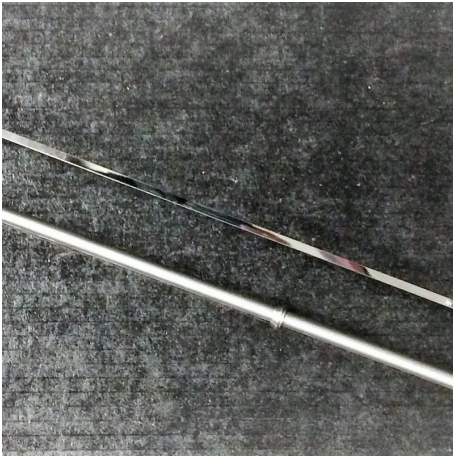

OS40110 DIPSTICK TUBE CHROME W/ CHROME DIPSTICK

SKU: OS40110

Dipstick Tube chrome with chrome dipstick

[Read More](#)

Price: \$45.00



OS40010 DIPSTICK TUBE UNIVERSAL, OE

SKU: OS40010

Universal, OE

[Read More](#)

Price: \$100.00



OS10112 OIL PAN STUD KIT STAINLESS, (W/ SERRATED LOCKING NUTS)

SKU: OS10112

Oil Pan Stud Kit Stainless, with serrated locking nuts for steel pans

[Read More](#)

Price: \$35.00



EX40102 HEADER BOLT LOCK WASHER KIT

SKU: EX40102

Header Bolt Lock Washer Kit

[Read More](#)

Price: \$15.00



EX40101 HEADER BOLT SET (12 POINT BLACK OXIDE BOLTS)

SKU: EX40101

Header Bolt Set 16-12 point black oxide bolts

[Read More](#)

Price: \$25.00



EX20111 EXHAUST MANIFOLD COLLECTOR STUDS W/ BRASS NUTS

SKU: EX20111

Exhaust Manifold Collector Studs w/ Brass Nuts

Stud and nut kit for exhaust manifolds (for attaching pipes directly to manifolds, without EFE valve). Steel stud with brass nut, 2 each (1 manifold worth) Fits 472 / 500 / 425 manifolds. 368 Manifolds need 1.5 kits per manifold (3 studs).

[Read More](#)

Price: \$12.00



EX20102 EXHAUST MANIFOLD BOLT SET, SHORT (8 BOLT SET) BLACK FLANGE HEAD HEX BOLTS

SKU: EX20102

Short exhaust manifold bolts (1" long bolts), 1/2 set (8 bolts) 2 sets required per engine.

[Read More](#)

Price: \$12.00

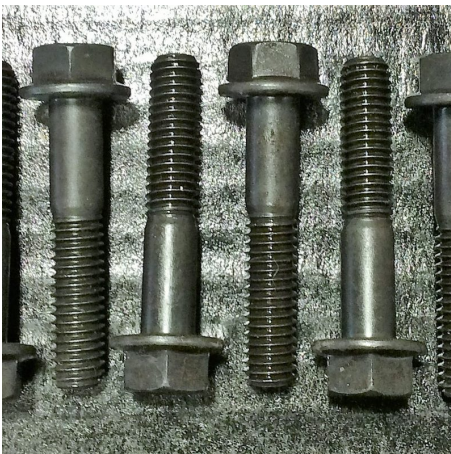

EX20101 EXHAUST MANIFOLD BOLT SET, LONG (8 BOLT SET) BLACK FLANGE HEAD HEX BOLTS

SKU: EX20101

Long exhaust manifold bolts (2" long bolts), 1/2 set (8 bolts) 2 sets required per engine.

[Read More](#)

Price: \$12.00



DS20141 STARTER BOLTS OE STYLE FOR FULL SIZE STARTER RWD

SKU: DS20141

Starter Bolts OE Style for full size starter

[Read More](#)

Price: \$15.00



DS10113 FLEXPLATE AND FLYWHEEL BOLTS, ARP, PRO-SERIES CHROMOLY

SKU: DS10113

ARP Heavy Duty Chromoly Flex Plate and Fly Wheel Bolts

Fits with billet steel flexplate or flywheel.

Can also be used with factory, stock replacement, and stamped steel aftermarket flex plates.

Heavy duty bolts for high-power applications.

[Read More](#)

Price: \$45.00



DS10112 FLEXPLATE AND FLYWHEEL BOLTS, ARP CHROMOLY

SKU: DS10112

ARP Chromoly Flex Plate and Fly Wheel Bolts

Fits with billet steel flexplate or flywheel.

Can also be used with factory, stock replacement, and stamped steel aftermarket flex plates.

[Read More](#)

Price: \$39.00



DS10111 FLEXPLATE BOLTS ARP CHROMOLY

SKU: DS10111

ARP Chromoly Flex plate Bolts

Fits with factory, stock replacement, and stamped steel aftermarket flex plates.

Does not fit billet steel flexplate or flywheel.

[Read More](#)

Price: \$40.00



AF80110 ARP™ HEAD STUD KIT

SKU: AF80110

Head Stud Kit

ARP 4130 Chromoly with nuts and washers

[Read More](#)

Price: \$215.00

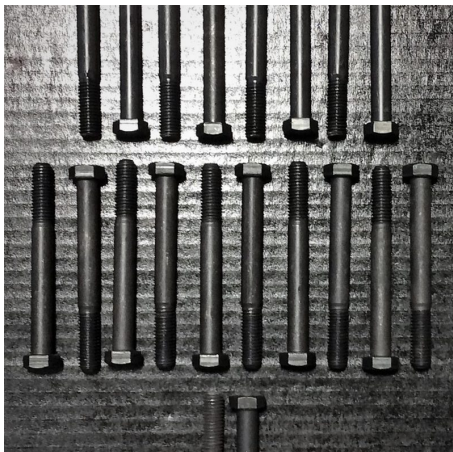

AF80101 CYLINDER HEAD BOLTS NEW (STOCK STYLE CYLINDER HEAD BOLTS)

SKU: AF80101

New stock style cylinder head bolts

[Read More](#)

Price: \$125.00

EXTERNAL PARTS FASTENERS



VT10102 TIMING COVER/WATER PUMP BOLT KIT STAINLESS SOCKET HEAD

SKU: VT10102

Timing Cover/Water Pump Bolt Kit Stainless Socket Head

[Read More](#)

Price: \$35.00



TS11209 EXHAUST BOLT REMOVAL TOOL KIT

SKU: TS11209

Manibolt Driller tool / fixture kit, makes removing broken bolts a 'snap', often without pulling the heads or engine out of the car.

With this precision tool you can drill and tap broken exhaust manifold bolts dead center and perfectly straight, every time, even if you can't see where you're drilling!

This kit fits all '68-'85 Cadillac 472 / 500 / 425 / 368 Cadillac engines.

Kit includes: Bushing Clamp (Qty 3, sizes 1/8 1/4 and 5/16), Drills and Taps (Qty 1 ea. 1/8 1/4 and 5/16 with 3/8-16 Tap), Knurled Thumbscrew for mounting Bushing Clamps, Modified 3/8-16 Stainless Flatheads (Qty 4), and a Rugged plastic case with laser cut foam fitted for dedicated placement.

For more information, see the detailed info tab.

You can also visit Beydler's website [here](#) for how-to videos and more.

[Read More](#)

Price: \$450.00



OS10112 OIL PAN STUD KIT STAINLESS, (W/ SERRATED LOCKING NUTS)

SKU: OS10112

Oil Pan Stud Kit Stainless, with serrated locking nuts for steel pans

[Read More](#)

Price: \$35.00



EX40102 HEADER BOLT LOCK WASHER KIT

SKU: EX40102

Header Bolt Lock Washer Kit

[Read More](#)

Price: \$15.00



EX40101 HEADER BOLT SET (12 POINT BLACK OXIDE BOLTS)

SKU: EX40101

Header Bolt Set 16-12 point black oxide bolts

[Read More](#)

Price: \$25.00



EX20111 EXHAUST MANIFOLD COLLECTOR STUDS W/ BRASS NUTS

SKU: EX20111

Exhaust Manifold Collector Studs w/ Brass Nuts

Stud and nut kit for exhaust manifolds (for attaching pipes directly to manifolds, without EFE valve). Steel stud with brass nut, 2 each (1 manifold worth) Fits 472 / 500 / 425 manifolds. 368 Manifolds need 1.5 kits per manifold (3 studs).

[Read More](#)

Price: \$12.00



EX20102 EXHAUST MANIFOLD BOLT SET, SHORT (8 BOLT SET) BLACK FLANGE HEAD HEX BOLTS

SKU: EX20102

Short exhaust manifold bolts (1" long bolts), 1/2 set (8 bolts) 2 sets required per engine.

[Read More](#)

Price: \$12.00

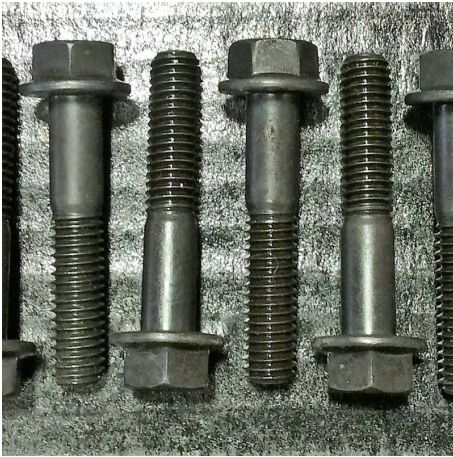

EX20101 EXHAUST MANIFOLD BOLT SET, LONG (8 BOLT SET) BLACK FLANGE HEAD HEX BOLTS

SKU: EX20101

Long exhaust manifold bolts (2" long bolts), 1/2 set (8 bolts) 2 sets required per engine.

[Read More](#)

Price: \$12.00



DS20141 STARTER BOLTS OE STYLE FOR FULL SIZE STARTER RWD

SKU: DS20141

Starter Bolts OE Style for full size starter

[Read More](#)

Price: \$15.00



DS10113 FLEXPLATE AND FLYWHEEL BOLTS, ARP, PRO-SERIES CHROMOLY

SKU: DS10113

ARP Heavy Duty Chromoly Flex Plate and Fly Wheel Bolts

Fits with billet steel flexplate or flywheel.
Can also be used with factory, stock replacement, and stamped steel aftermarket flex plates.

Heavy duty bolts for high-power applications.

[Read More](#)

Price: \$45.00



DS10112 FLEXPLATE AND FLYWHEEL BOLTS, ARP CHROMOLY

SKU: DS10112

ARP Chromoly Flex Plate and Fly Wheel Bolts

Fits with billet steel flexplate or flywheel.
Can also be used with factory, stock replacement, and stamped steel aftermarket flex plates.

[Read More](#)

Price: \$39.00



DS10111 FLEXPLATE BOLTS ARP CHROMOLY

SKU: DS10111

ARP Chromoly Flex plate Bolts

Fits with factory, stock replacement, and stamped steel aftermarket flex plates.
Does not fit billet steel flexplate or flywheel.

[Read More](#)

Price: \$40.00

LONG BLOCK FASTENERS



VT15111 CAM GEAR BOLTS ARP (SHALLOW HEAD)

SKU: VT15111

Cam Gear Bolts ARP shallow head

[Read More](#)

Price: \$10.00

RB40111 CRANK KEY

SKU: RB40111

Crankshaft key for timing gear / crank hub for Cadillac 472 / 500 / 425 / 368 engines. The correct factory style key. Nothing special, just the right thing.

[Read More](#)

Price: \$6.00





RB30121 ROD BOLTS ARP CHROMOLY W/ NUTS

SKU: RB30121

Rod Bolts ARP Chromoly with nuts

[Read More](#)

Price: \$95.00



RB10132 LONG MAIN STUD KIT ARP 4130 CHROMOLY (W/ NUTS AND WASHERS)

SKU: RB10132

for use with main girdle

[Read More](#)

Price: \$175.00



RB10131 MAIN STUD KIT ARP 4130 CHROMOLY - (W/ NUTS AND WASHERS)

SKU: RB10131

Main Stud Kit ARP 4130 Chromoly with nuts and washers

[Read More](#)

Price: \$145.00



PB11122 CRANK HUB BOLT AND WASHER KIT

SKU: PB11122

Crank Hub Bolt and Washer Kit Correct washer to clear the pulley. Fits the front of the crankshaft, to positively retain the crank hub or damper (or dampener or balancer, as some folks call them).

[Read More](#)

Price: \$15.00



AF80110 ARP™ HEAD STUD KIT

SKU: AF80110

Head Stud Kit

ARP 4130 Chromoly with nuts and washers

[Read More](#)

Price: \$215.00

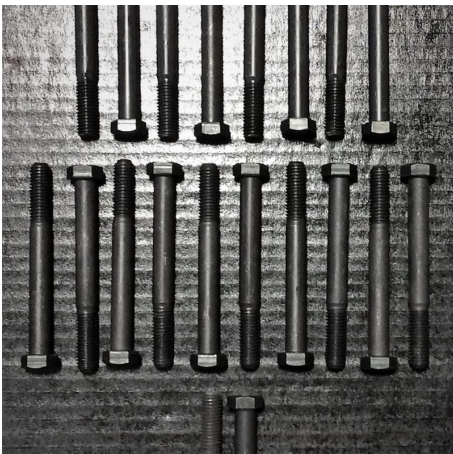

AF80101 CYLINDER HEAD BOLTS NEW (STOCK STYLE CYLINDER HEAD BOLTS)

SKU: AF80101

New stock style cylinder head bolts

[Read More](#)

Price: \$125.00

IGNITION SYSTEMS



WS51204 HEI POWER / TACH PIGTAILS

SKU: WS51204

Original GM parts with 8"+ wire pigtails.

[Read More](#)

Price: \$45.00



IG97301 MSD WIRE LOOM CLIP KITS

SKU: IG97301

Black. Simple, clean, easy to use.

[Read More](#)

Price: \$35.00



IG97204 EDELBROCK 22799 SPARK PLUG WIRE SEPARATORS

SKU: IG97204

[Read More](#)

Price: \$20.95





IG97203 BUDGET SILICONE WIRE LOOM KIT

SKU: IG97203

Blue high-temp silicone

[Read More](#)

Price: \$20.00



IG95311 EDELBROCK 22710 MAX-FIRE (ULTRA-SPARK 50) HIGH PERFORMANCE SPARK PLUG WIRE SET

SKU: IG95311

[Read More](#)

Price: \$89.95



IG95301 MSD 8.5MM WIRES

SKU: IG95301

For HEI and aftermarket distributors. Coil wire included. Also available in colors - call for more information.

[Read More](#)

Price: \$135.00



IG95201 BELDEN 8MM WIRES

SKU: IG95201

For HEI and aftermarket distributors.

[Read More](#)

Price: \$85.00



IG95101 BELDEN 7MM WIRES

SKU: IG95101

For points type distributors. Includes coil wire.

[Read More](#)

Price: \$55.00





IG71102 MSD 6A CONTROL UNIT

SKU: IG71102

MSD 6A Control Unit

[Read More](#)

Price: \$350.00



IG71101 MSD 6AL CONTROL UNIT

SKU: IG71101

With built in rev limiter.

[Read More](#)

Price: \$425.00



IG57302 CHROME BRACKET AND COIL COVER

SKU: IG57302

For canister style coils.

[Read More](#)

Price: \$12.00



IG55202 MSD BLASTER HVC COIL

SKU: IG55202

For reliability under extreme conditions.

[Read More](#)

Price: \$210.00



IG55201 MSD STREET BLASTER COIL

SKU: IG55201

modern 12V square style.

[Read More](#)

Price: \$130.00

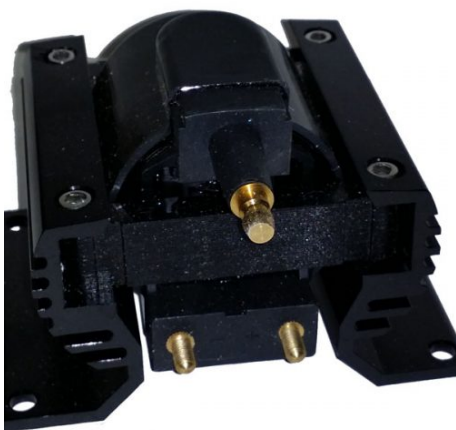

IG55102 RACE STYLE E-COIL

SKU: IG55102

[Read More](#)

Price: \$75.00



IG55101 PRO-STYLE COIL

SKU: IG55101

[Read More](#)

Price: \$60.00



IG51302 MSD BLASTER 2 COIL

SKU: IG51302

points canister style.

[Read More](#)

Price: \$80.00



IG37032 COMPOSITE DISTRIBUTOR GEAR FOR MSD

SKU: IG37032

Composite Distributor Gear for MSD Pro Billet distributor

[Read More](#)

Price: \$138.95



IG37031 COMPOSITE DISTRIBUTOR GEAR FOR OE DISTRIBUTOR

SKU: IG37031

Composite Distributor Gear for OE Distributor

[Read More](#)

Price: \$138.95



IG37022 MELONIZED DISTRIBUTOR GEAR FOR MSD

SKU: IG37022

Melonized Distributor Gear for MSD Pro Billet distributor

[Read More](#)

Price: \$103.95



IG37021 MELONIZED DISTRIBUTOR GEAR FOR OE DISTRIBUTOR

SKU: IG37021

Melonized Distributor Gear for OE Distributor

[Read More](#)

Price: \$108.95



IG37013 DISTRIBUTOR SHIMS

SKU: IG37013

For setting shaft endplay.

[Read More](#)

Price: \$10.00



IG37012 BRONZE DISTRIBUTOR GEAR FOR MSD

SKU: IG37012

Bronze Distributor Gear for MSD Pro Billet distributor

[Read More](#)

Price: \$58.95



IG37011 BRONZE DISTRIBUTOR GEAR FOR OE DISTRIBUTOR

SKU: IG37011

Bronze Distributor Gear for OE distributor

[Read More](#)

Price: \$60.95



IG37002 IRON DISTRIBUTOR GEAR FOR MSD

SKU: IG37002

Iron Distributor Gear for MSD Pro Billet distributor

[Read More](#)

Price: \$62.78



IG35101 DISTRIBUTOR CLAMP

SKU: IG35101

Billet aluminum. Allows Removal of distributor without removal of clamp.

[Read More](#)

Price: \$55.00



IG33100 TUNE-UP KIT FOR HEI

SKU: IG33100

Includes Harness & Module • Curve Kit • Adjustable Vacuum Advance w/ Tool • High Performance Cap, Rotor & Performance Coil

[Read More](#)

Price: \$195.00



IG31102 PREMIUM ELECTRONIC IGNITION CONVERSION KIT

SKU: IG31102

Reads from existing lobes

[Read More](#)

Price: \$150.00



IG15113 BILLET STANDALONE SMALL CAP DISTRIBUTOR, BLACK

SKU: IG15113

Billet Standalone Small Cap Distributor

Black cap

[Read More](#)

Price: \$275.00



IG15112 BILLET STANDALONE SMALL CAP DISTRIBUTOR, RED

SKU: IG15112

Billet Standalone Small Cap Distributor

Red cap

[Read More](#)

Price: \$275.00



IG15101 MSD PRO BILLET DISTRIBUTOR

SKU: IG15101

All New, Billet Case

[Read More](#)

Price: \$445.00



IG13110 CAD COMPANY NEW HEI DISTRIBUTOR

SKU: IG13110

Cad Company complete HEI Distributor

All new distributor

Curve Kit with extra springs provided

Adjustable Vacuum Advance w/ Tool

Black or Red High Performance Distributor Cap & Rotor

Performance Coil

[Read More](#)

Price: \$250.00



DUAL SYNC DISTRIBUTOR

SKU: N/A

[Read More](#)

Price: \$800.00





505-823-9340
8333 JEFFERSON NE
ALBUQUERQUE, NM 87113
CADILLACPERFORMANCE.COM

DISTRIBUTOR COMPONENTS



IG97204 EDELBROCK 22799 SPARK PLUG WIRE SEPARATORS

SKU: IG97204

[Read More](#)

Price: \$20.95



IG95311 EDELBROCK 22710 MAX-FIRE (ULTRA-SPARK 50) HIGH PERFORMANCE SPARK PLUG WIRE SET

SKU: IG95311

[Read More](#)

Price: \$89.95



IG37032 COMPOSITE DISTRIBUTOR GEAR FOR MSD

SKU: IG37032

Composite Distributor Gear for MSD Pro Billet distributor

[Read More](#)

Price: \$138.95





IG37031 COMPOSITE DISTRIBUTOR GEAR FOR OE DISTRIBUTOR

SKU: IG37031

Composite Distributor Gear for OE Distributor

[Read More](#)

Price: \$138.95



IG37022 MELONIZED DISTRIBUTOR GEAR FOR MSD

SKU: IG37022

Melonized Distributor Gear for MSD Pro Billet distributor

[Read More](#)

Price: \$103.95



IG37021 MELONIZED DISTRIBUTOR GEAR FOR OE DISTRIBUTOR

SKU: IG37021

Melonized Distributor Gear for OE Distributor

[Read More](#)

Price: \$108.95



IG37013 DISTRIBUTOR SHIMS

SKU: IG37013

For setting shaft endplay.

[Read More](#)

Price: \$10.00



IG37012 BRONZE DISTRIBUTOR GEAR FOR MSD

SKU: IG37012

Bronze Distributor Gear for MSD Pro Billet distributor

[Read More](#)

Price: \$58.95



IG37011 BRONZE DISTRIBUTOR GEAR FOR OE DISTRIBUTOR

SKU: IG37011

Bronze Distributor Gear for OE distributor

[Read More](#)

Price: \$60.95



IG37002 IRON DISTRIBUTOR GEAR FOR MSD

SKU: IG37002

Iron Distributor Gear for MSD Pro Billet distributor

[Read More](#)

Price: \$62.78

DISTRIBUTORS



WS51204 HEI POWER / TACH PIGTAILS

SKU: WS51204

Original GM parts with 8"+ wire pigtails.

[Read More](#)

Price: \$45.00



IG15113 BILLET STANDALONE SMALL CAP DISTRIBUTOR, BLACK

SKU: IG15113

Billet Standalone Small Cap Distributor

Black cap

[Read More](#)

Price: \$275.00



IG15112 BILLET STANDALONE SMALL CAP DISTRIBUTOR, RED

SKU: IG15112

Billet Standalone Small Cap Distributor

Red cap

[Read More](#)

Price: \$275.00



IG15101 MSD PRO BILLET DISTRIBUTOR

SKU: IG15101

All New, Billet Case

[Read More](#)

Price: \$445.00



IG13110 CAD COMPANY NEW HEI DISTRIBUTOR

SKU: IG13110

Cad Company complete HEI Distributor

All new distributor

Curve Kit with extra springs provided

Adjustable Vacuum Advance w/ Tool

Black or Red High Performance Distributor Cap & Rotor

Performance Coil

[Read More](#)

Price: \$250.00



DUAL SYNC DISTRIBUTOR

SKU: N/A

[Read More](#)

Price: \$800.00



ELECTRONIC CONVERSION KITS FOR POINTS DISTRIBUTORS



IG31102 PREMIUM ELECTRONIC IGNITION CONVERSION KIT

SKU: IG31102

Reads from existing lobes

[Read More](#)

Price: \$150.00



IGNITION COILS

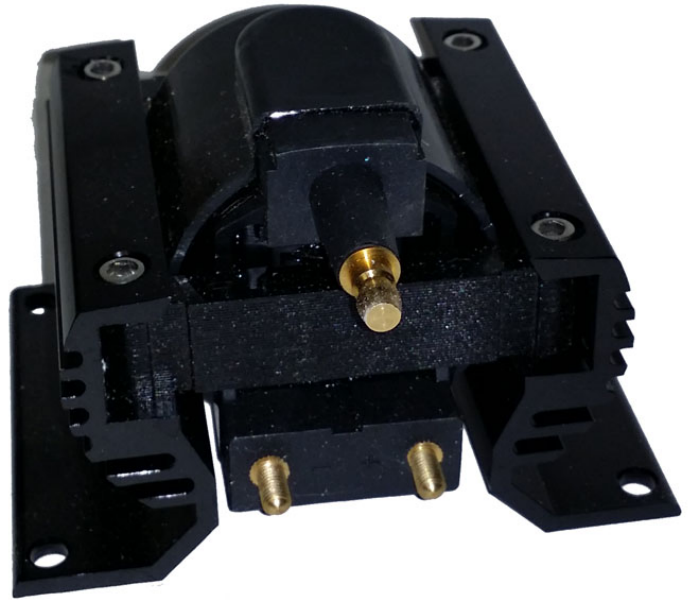

IG57302 CHROME BRACKET AND COIL COVER

SKU: IG57302

For canister style coils.

[Read More](#)

Price: \$12.00



IG55202 MSD BLASTER HVC COIL

SKU: IG55202

For reliability under extreme conditions.

[Read More](#)

Price: \$210.00





IG55201 MSD STREET BLASTER COIL

SKU: IG55201

modern 12V square style.

[Read More](#)

Price: \$130.00

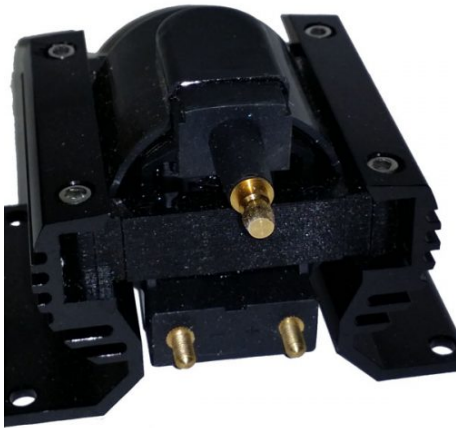

IG55102 RACE STYLE E-COIL

SKU: IG55102

[Read More](#)

Price: \$75.00



IG55101 PRO-STYLE COIL

SKU: IG55101

[Read More](#)

Price: \$60.00



IG51302 MSD BLASTER 2 COIL

SKU: IG51302

points canister style.

[Read More](#)

Price: \$80.00

IGNITION CONTROL BOXES AND ACCESSORIES



IG71102 MSD 6A CONTROL UNIT

SKU: IG71102

MSD 6A Control Unit

[Read More](#)

Price: \$350.00



IG71101 MSD 6AL CONTROL UNIT

SKU: IG71101

With built in rev limiter.

[Read More](#)

Price: \$425.00



IG35101 DISTRIBUTOR CLAMP

SKU: IG35101

Billet aluminum. Allows Removal of distributor without removal of clamp.

[Read More](#)

Price: \$55.00



IG33100 TUNE-UP KIT FOR HEI

SKU: IG33100

Includes Harness & Module • Curve Kit • Adjustable Vacuum Advance w/
Tool • High Performance Cap, Rotor & Performance Coil

[Read More](#)

Price: \$195.00

SPARK PLUG WIRES AND LOOMS



IG97301 MSD WIRE LOOM CLIP KITS

SKU: IG97301

Black. Simple, clean, easy to use.

[Read More](#)

Price: \$35.00



IG97204 EDELBROCK 22799 SPARK PLUG WIRE SEPARATORS

SKU: IG97204

[Read More](#)

Price: \$20.95





IG97203 BUDGET SILICONE WIRE LOOM KIT

SKU: IG97203

Blue high-temp silicone

[Read More](#)

Price: \$20.00

IG95311 EDELBROCK 22710 MAX-FIRE (ULTRA-SPARK 50) HIGH PERFORMANCE SPARK PLUG WIRE SET

SKU: IG95311

[Read More](#)

Price: \$89.95





IG95301 MSD 8.5MM WIRES

SKU: IG95301

For HEI and aftermarket distributors. Coil wire included.
Also available in colors - call for more information.

[Read More](#)

Price: \$135.00



IG95201 BELDEN 8MM WIRES

SKU: IG95201

For HEI and aftermarket distributors.

[Read More](#)

Price: \$85.00



IG95101 BELDEN 7MM WIRES

SKU: IG95101

For points type distributors. Includes coil wire.

[Read More](#)

Price: \$55.00

OIL LUBE AND CHEMICALS



OL95111 BLUE DYKEM LAYOUT FLUID

SKU: OL95111

4 oz bottle, brush on

[Read More](#)

Price: \$18.00



OILING SYSTEM

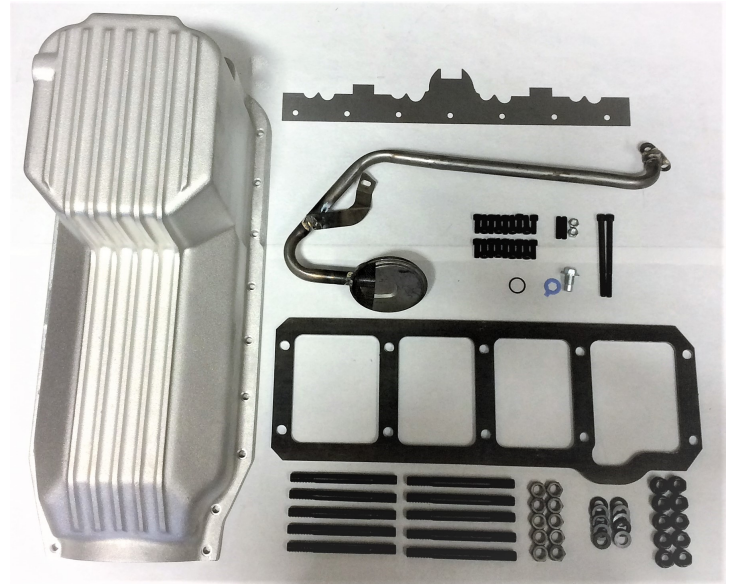

TS31101 OIL PRIMER TOOL FOR '66 AND UP CADILLACS

SKU: TS31101

Oil Primer Tool for '66 and up Cadillacs

[Read More](#)

Price: \$25.00



RB19302 BOTTOM END KIT

SKU: RB19302

Bottom End Kit \$875 and up

[Read More](#)

Price: \$895.00

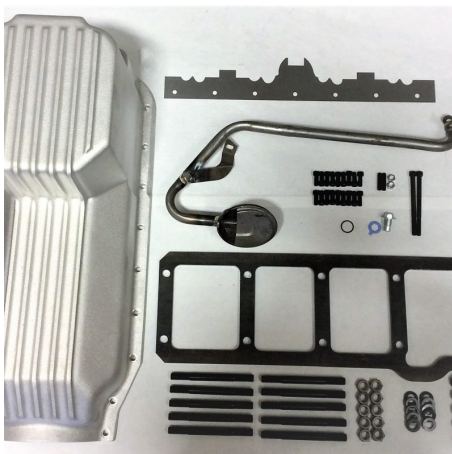



OS65011 OIL COOLER ADAPTER SANDWICH STYLE

SKU: OS65011

Oil Cooler Adapter Sandwich style, fits between filter and pump

[Read More](#)

Price: \$49.00



OS63012 OIL FILTER ADAPTER LINES EXIT STRAIGHT

SKU: OS63012

[Read More](#)

Price: \$45.00



OS63011 REMOTE OIL FILTER ADAPTER-- SIDE EXIT

SKU: OS63011

[Read More](#)

Price: \$45.00



OS61123 BILLET OIL FILTER

SKU: OS61123

[Read More](#)

Price: \$160.00

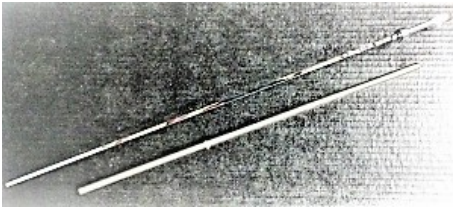

OS40220 DIPSTICK TUBE POLISHED STAINLESS STEEL W/ CHROME DIPSTICK

SKU: OS40220

Dipstick Tube Polished stainless steel with chrome dipstick

[Read More](#)

Price: \$75.00

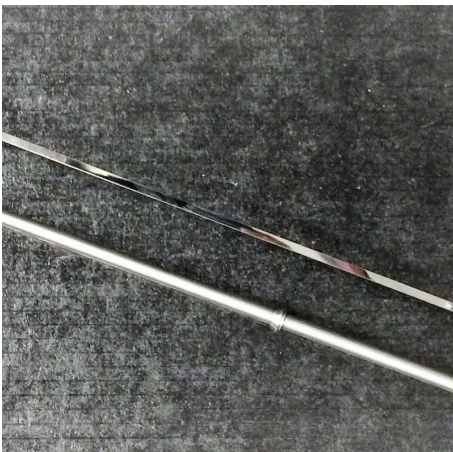

OS40210 DIPSTICK TUBE STAINLESS STEEL W/ CHROME DIPSTICK

SKU: OS40210

Dipstick Tube Stainless steel with chrome dipstick

[Read More](#)

Price: \$49.00

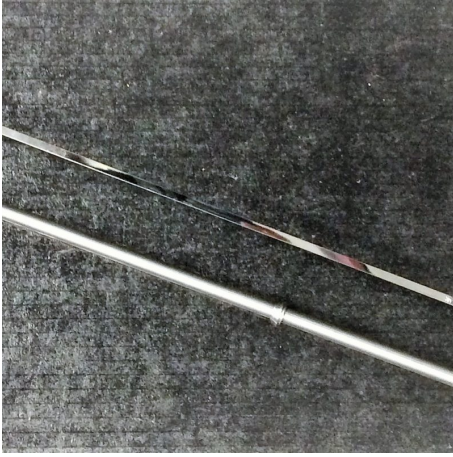

OS40110 DIPSTICK TUBE CHROME W/ CHROME DIPSTICK

SKU: OS40110

Dipstick Tube chrome with chrome dipstick

[Read More](#)

Price: \$45.00



OS40010 DIPSTICK TUBE UNIVERSAL, OE

SKU: OS40010

Universal, OE

[Read More](#)

Price: \$100.00

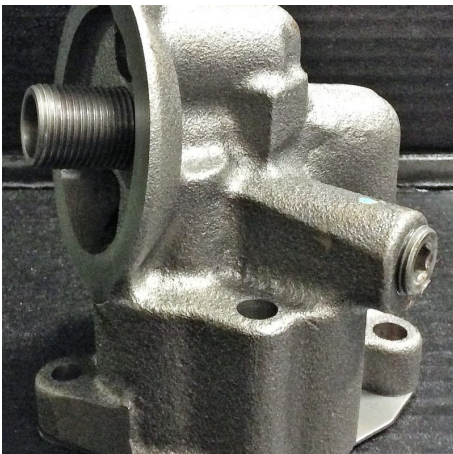

OS31122 GOLD SERIES "SPECIAL CHASSIS" OIL PUMP

SKU: OS31122

Gold Series "Special Chassis" Oil Pump

[Read More](#)

Price: \$329.41



OS31121 GOLD SERIES "STANDARD BODY" OIL PUMP

SKU: OS31121

Gold Series "Standard Body" Oil Pump

[Read More](#)

Price: \$229.41

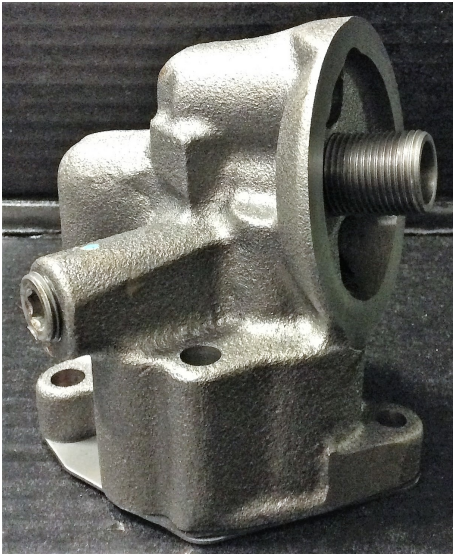

OS31112 OE REPLACEMENT "SPECIAL CHASSIS" OIL PUMP

SKU: OS31112*

OE Replacement "Special Chassis" Oil Pump

[Read More](#)

Price: \$268.60

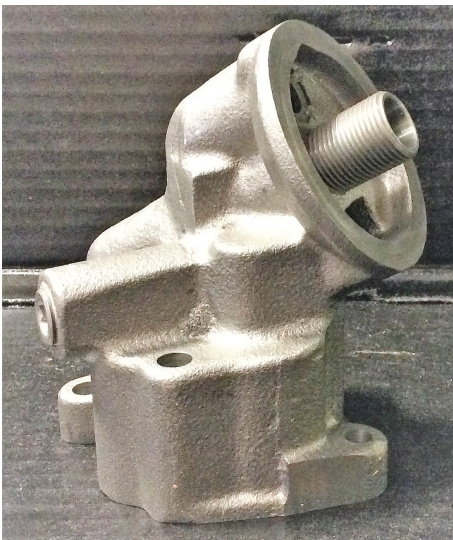

OS31111 OE REPLACEMENT "STANDARD BODY" OIL PUMP

SKU: OS31112

OE Replacement "Standard Body" Oil Pump

[Read More](#)

Price: \$168.60

OS31101 OIL PUMP REBUILD KIT

SKU: OS31101

[Read More](#)

Price: \$120.00



OS30201 OIL PUMP DRIVE SHAFT NEW, FITS '68-'85 472/500/472/368 ENGINES'

SKU: OS30201

Oil Pump Drive Shaft New, fits '68-'85 472/500/472/368 engines

[Read More](#)

Price: \$49.95



OS23123 REAR SUMP OIL PICKUP TUBE MADE IN USA

SKU: OS23123

Rear Sump Oil Pickup Tube OE Spec, Made in USA

[Read More](#)

Price: \$195.00

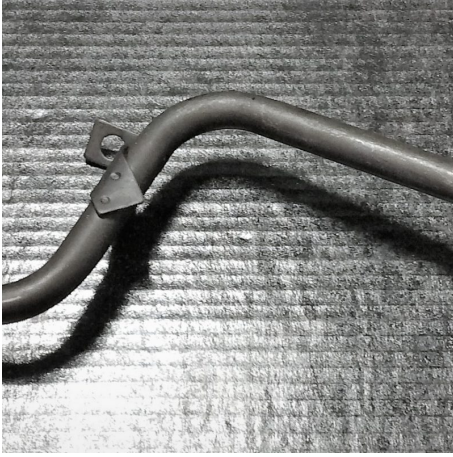

OS21131 MID SUMP ('77-'79 RWD) OIL PICKUP TUBE OE SPEC, MADE IN USA

SKU: OS21131

Note: Standard pickup tubes fit '70-newer blocks. For '68 / '69 472 blocks, order the 'small oil galley pickup modification' for an additional \$20.

[Read More](#)

Price: \$95.00



OS21111 FRONT SUMP ('68-'76 RWD) OIL PICKUP TUBE

SKU: OS21111

Front Sump ('68-'76 RWD) Oil Pickup Tube

[Read More](#)

Price: \$105.00



OS13122 REAR SUMP ALUMINUM OIL PAN

SKU: OS13122

All non-Eldo 68-up Cadillacs came with either a front sump or mid-sump oil pan.

A true rear sump pan is generally required for most non-Ford swaps, including all of our bolt-in kits.

GMC motorhomes and Eldorados require an original Eldo oil pan - aftermarket pans will not fit.

'65-'67 Cadillacs require a front sump oil pan, as found on '68-'76 non-Eldo Cadillacs.

[Read More](#)

Price: \$552.00





OS10151 CRANK SCRAPER

SKU: OS10151

[Read More](#)

Price: \$55.00



OS10112 OIL PAN STUD KIT STAINLESS, (W/ SERRATED LOCKING NUTS)

SKU: OS10112

Oil Pan Stud Kit Stainless, with serrated locking nuts for steel pans

[Read More](#)

Price: \$35.00

DIPSTICKS AND TUBES

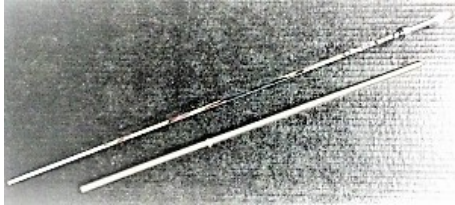
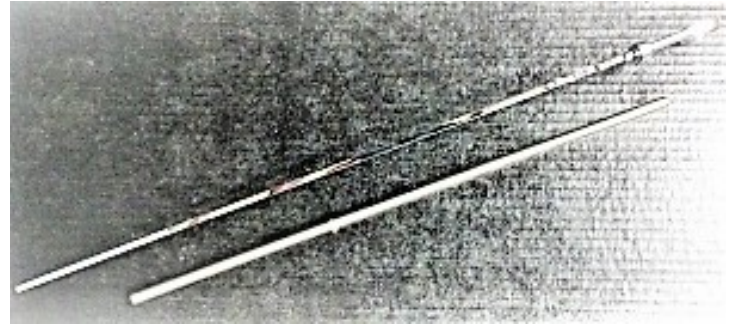

OS40220 DIPSTICK TUBE POLISHED STAINLESS STEEL W/ CHROME DIPSTICK

SKU: OS40220

Dipstick Tube Polished stainless steel with chrome dipstick

[Read More](#)

Price: \$75.00

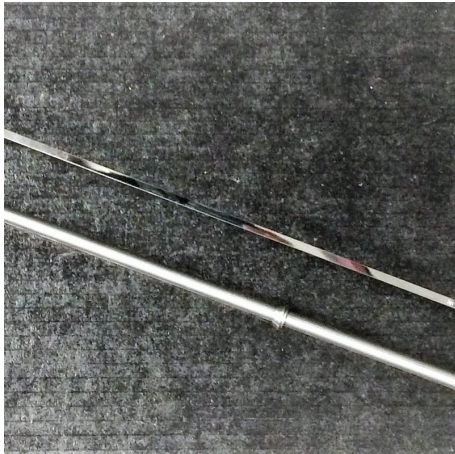

OS40210 DIPSTICK TUBE STAINLESS STEEL W/ CHROME DIPSTICK

SKU: OS40210

Dipstick Tube Stainless steel with chrome dipstick

[Read More](#)

Price: \$49.00

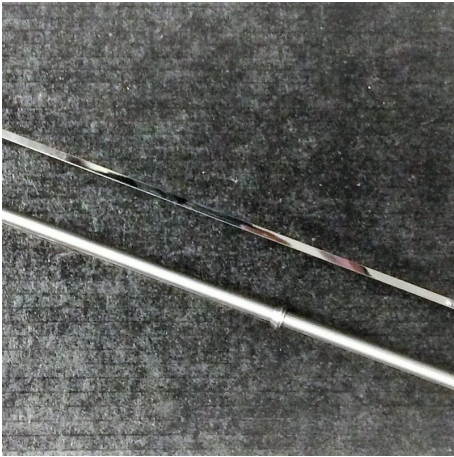

OS40110 DIPSTICK TUBE CHROME W/ CHROME DIPSTICK

SKU: OS40110

Dipstick Tube chrome with chrome dipstick

[Read More](#)

Price: \$45.00



OS40010 DIPSTICK TUBE UNIVERSAL, OE

SKU: OS40010

Universal, OE

[Read More](#)

Price: \$100.00

FILTERS



OS65011 OIL COOLER ADAPTER SANDWICH STYLE

SKU: OS65011

Oil Cooler Adapter Sandwich style, fits between filter and pump

[Read More](#)

Price: \$49.00



OS63012 OIL FILTER ADAPTER LINES EXIT STRAIGHT

SKU: OS63012

[Read More](#)

Price: \$45.00





OS63011 REMOTE OIL FILTER ADAPTER-- SIDE EXIT

SKU: OS63011

[Read More](#)

Price: \$45.00



OS61123 BILLET OIL FILTER

SKU: OS61123

[Read More](#)

Price: \$160.00

OIL PANS

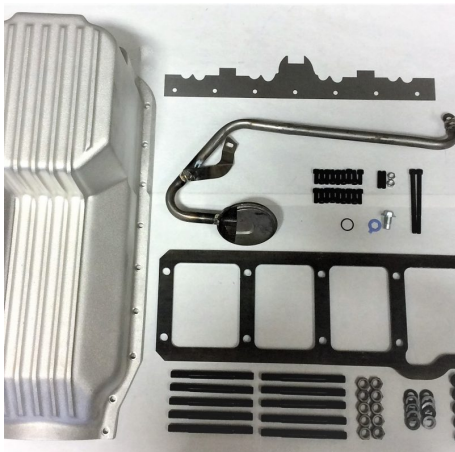

RB19302 BOTTOM END KIT

SKU: RB19302

Bottom End Kit \$875 and up

[Read More](#)

Price: \$895.00



OS40010 DIPSTICK TUBE UNIVERSAL, OE

SKU: OS40010

Universal, OE

[Read More](#)

Price: \$100.00



OS13122 REAR SUMP ALUMINUM OIL PAN

SKU: OS13122

All non-Eldo 68-up Cadillacs came with either a front sump or mid-sump oil pan.

A true rear sump pan is generally required for most non-Ford swaps, including all of our bolt-in kits.

GMC motorhomes and Eldorados require an original Eldo oil pan - aftermarket pans will not fit.

'65-'67 Cadillacs require a front sump oil pan, as found on '68-'76 non-Eldo Cadillacs.

[Read More](#)

Price: \$552.00



OS10151 CRANK SCRAPER

SKU: OS10151

[Read More](#)

Price: \$55.00



OS10112 OIL PAN STUD KIT STAINLESS, (W/ SERRATED LOCKING NUTS)

SKU: OS10112

Oil Pan Stud Kit Stainless, with serrated locking nuts for steel pans

[Read More](#)

Price: \$35.00

OIL PICKUP TUBES



OS23123 REAR SUMP OIL PICKUP TUBE MADE IN USA

SKU: OS23123

Rear Sump Oil Pickup Tube OE Spec, Made in USA

[Read More](#)

Price: \$195.00

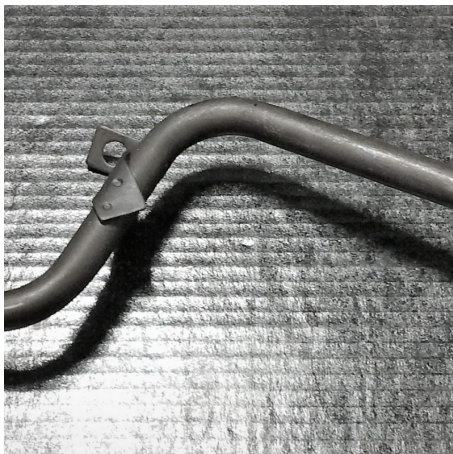

OS21131 MID SUMP ('77-'79 RWD) OIL PICKUP TUBE OE SPEC, MADE IN USA

SKU: OS21131

Note: Standard pickup tubes fit '70-newer blocks. For '68 / '69 472 blocks, order the 'small oil galley pickup modification' for an additional \$20.

[Read More](#)

Price: \$95.00



OS21111 FRONT SUMP ('68-'76 RWD) OIL PICKUP TUBE

SKU: OS21111

Front Sump ('68-'76 RWD) Oil Pickup Tube

[Read More](#)

Price: \$105.00

OIL PUMPS

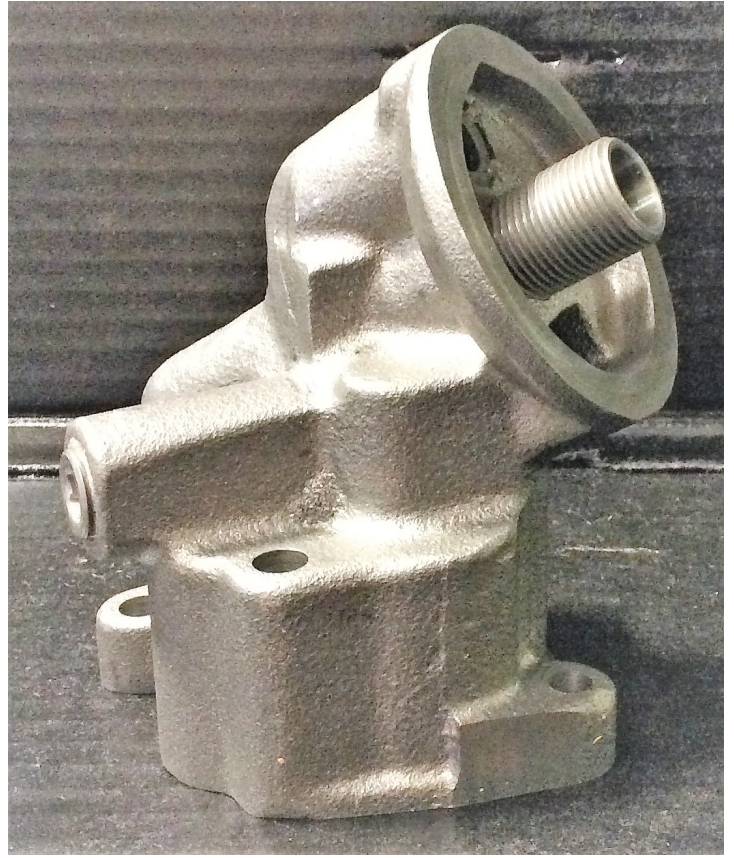

TS31101 OIL PRIMER TOOL FOR '66 AND UP CADILLACS

SKU: TS31101

Oil Primer Tool for '66 and up Cadillacs

[Read More](#)

Price: \$25.00



OS31122 GOLD SERIES "SPECIAL CHASSIS" OIL PUMP

SKU: OS31122

Gold Series "Special Chassis" Oil Pump

[Read More](#)

Price: \$329.41

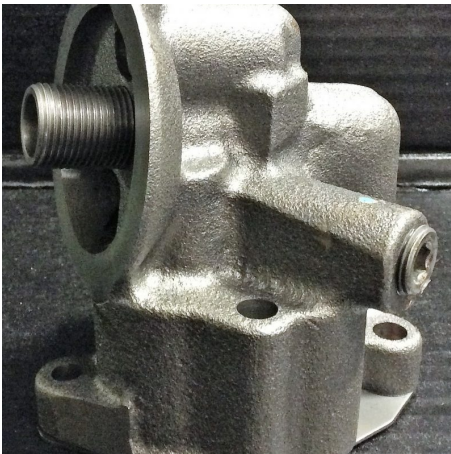



OS31121 GOLD SERIES "STANDARD BODY" OIL PUMP

SKU: OS31121

Gold Series "Standard Body" Oil Pump

[Read More](#)

Price: \$229.41

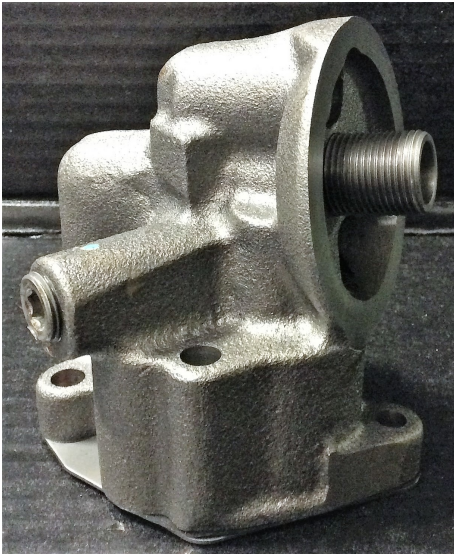

OS31112 OE REPLACEMENT "SPECIAL CHASSIS" OIL PUMP

SKU: OS31112*

OE Replacement "Special Chassis" Oil Pump

[Read More](#)

Price: \$268.60

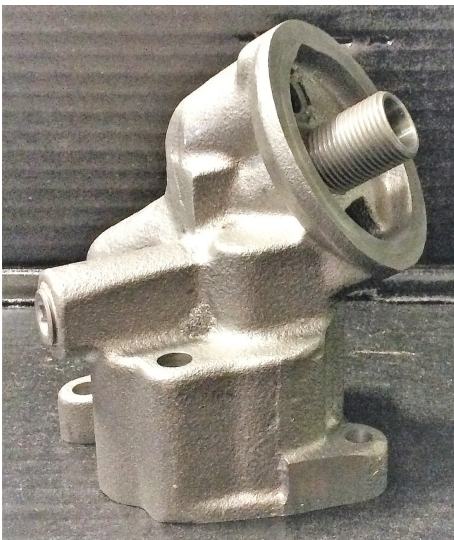

OS31111 OE REPLACEMENT "STANDARD BODY" OIL PUMP

SKU: OS31112

OE Replacement "Standard Body" Oil Pump

[Read More](#)

Price: \$168.60

OS31101 OIL PUMP REBUILD KIT

SKU: OS31101

[Read More](#)

Price: \$120.00



OS30201 OIL PUMP DRIVE SHAFT NEW, FITS '68-'85 472/500/472/368 ENGINES'

SKU: OS30201

Oil Pump Drive Shaft New, fits '68-'85 472/500/472/368 engines

[Read More](#)

Price: \$49.95

OVERHAUL ROTATING AND BOTTOM END PARTS



VT13174 TRUE ROLLER TIMING CHAIN SET

SKU: VT13174

[Read More](#)

Price: \$190.00



RB77102 CAM BEARINGS, CC3 GROOVED / DUAL HOLE STYLE

SKU: RB77102

Cam Bearings, CC3 grooved / dual hole style

[Read More](#)

Price: \$116.60



RB77101 CAM BEARINGS, STOCK REPLACEMENT

SKU: RB77101

Cam bearings, stock replacement style

[Read More](#)

Price: \$52.28



RB75110 CLEVITE 'H' SERIES ROD BEARINGS

SKU: RB75110

Clevite™ 'H' series rod bearings. Set of 8 pairs.

Recommended for competition use only.

[Read More](#)

Price: \$220.00



RB75100 ROD BEARINGS FOR 472 / 500 / 425 / 368

SKU: RB75100

Rod Bearings - set of 8 pairs for 472 / 500 / 425 / 368.

[Read More](#)

Price: \$187.20

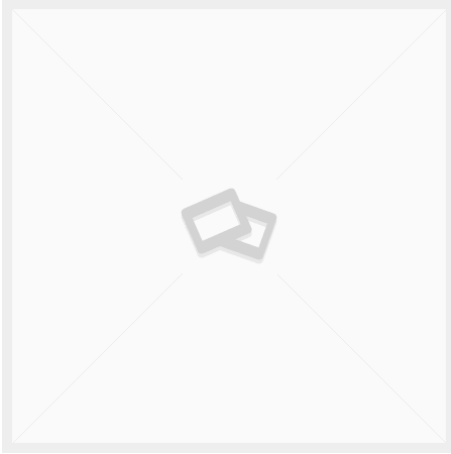

RB73101 ROD AND MAIN BEARING KIT FOR 472 / 500 / 425 / 368

SKU: RB73101

Rod and main bearing kit for 472 / 500 / 425 / 368.

Includes: Main Bearings, set of 5 pairs, Rod bearings set of 8 pairs.

[Read More](#)

Price: ~~\$402.93~~ \$362.64



RB71100 MAIN BEARINGS FOR 472 / 500 / 425 / 368

SKU: RB71100

Main Bearings, set of 5 pairs, for 472 / 500 / 425 / 368.

[Read More](#)

Price: \$215.73



RB59170 PISTON RING SET FOR 425

SKU: RB59170

Piston rings for 425 engines.

Standard width (5/64" / 5/64" / 3/16").

Complete set (1 set per engine).

We recommend Moly rings for most builds.

[Read More](#)

Price: \$105.17 - \$219.43

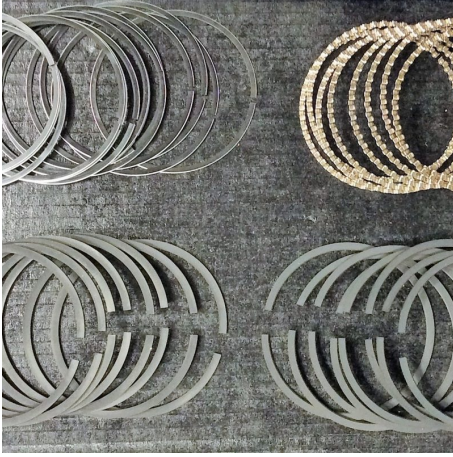

RB59115 SKINNY (1/16") MOLY PISTON RING SET FOR 472 / 500 FOR CAD COMPANY FORGED PISTONS

SKU: RB59115

'Skinny' Piston rings for 472 / 500 engines with Cad Company forged pistons.

Narrow width (1/16" / 1/16" / 3/16") - These rings ONLY fit forged pistons intended for skinny rings. Not applicable to stock replacement or KB pistons, or most forged pistons aside from the current Cad Company off-the-shelf forged pistons or something custom-made-to-order for these rings.

Complete set (1 set per engine).

Only available in Moly, and only available in the sizes listed.

[Read More](#)

Price: \$219.43

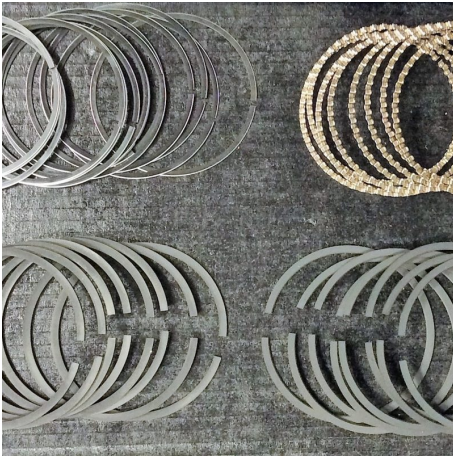

RB59110 PISTON RING SET FOR 472 / 500

SKU: RB59110

Piston rings for 472 / 500 engines.

Standard width (5/64" / 5/64" / 3/16") - for any off-the-shelf piston that does not specify narrow rings.

Complete set (1 set per engine).

We recommend Moly rings for most builds.

[Read More](#)

Price: \$120.00 - \$197.20



RB55472 10:1 FORGED PISTONS - 472 CID W/ 76CC HEADS - D-DISH

SKU: RB55472

Cad Company forged pistons - D-Dish - 10:1 compression for 472 CID Cadillac engines with 76cc heads. With coated skirts. Price includes pins. Valve reliefs clear iron and aluminum heads. Uses 1/16" ring pack for reduced friction. Made in USA

[Read More](#)

Price: \$750.00



RB55176 9:1 FORGED PISTONS - 500 CID - FLAT TOP

SKU: RB55176

Cad Company forged pistons - Flat Top - 9:1 compression for 500 CID Cadillac engines with 120cc heads (or 13:1 w/ 76cc heads). With coated skirts. Price includes pins. No valve reliefs. Uses 1/16" ring pack for reduced friction. Made in USA

[Read More](#)

Price: \$750.00

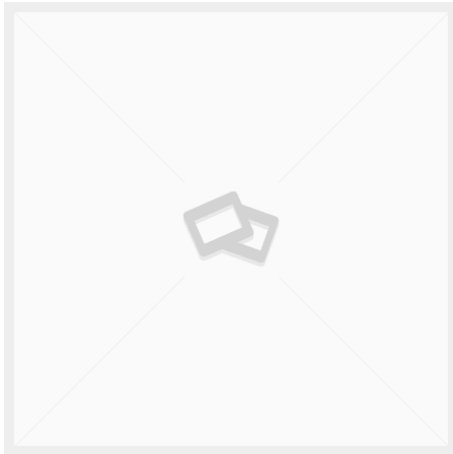

RB55174 10:1 FORGED PISTONS - 500 CID W/ 120CC HEADS - DOMED

SKU: RB55174

Cad Company forged pistons - D-Dish - 10:1 compression for 500 CID Cadillac engines with 120cc heads, or 14:1 compression for 500 CID Cadillac engines with 76cc OE or ported OE heads. With coated skirts. Price includes pins. Valve reliefs clear iron and aluminum heads. Uses 1/16" ring pack for reduced friction. Made in USA

[Read More](#)

Price: \$750.00



RB55172 10:1 FORGED PISTONS - 500 CID W/ 76CC HEADS - D-DISH

SKU: RB55172

Cad Company forged pistons - D-Dish - 10:1 compression for 500 CID Cadillac engines with 76cc heads. With coated skirts. Price includes pins. Valve reliefs clear iron and aluminum heads. Uses 1/16" ring pack for reduced friction. Made in USA

[Read More](#)

Price: \$750.00

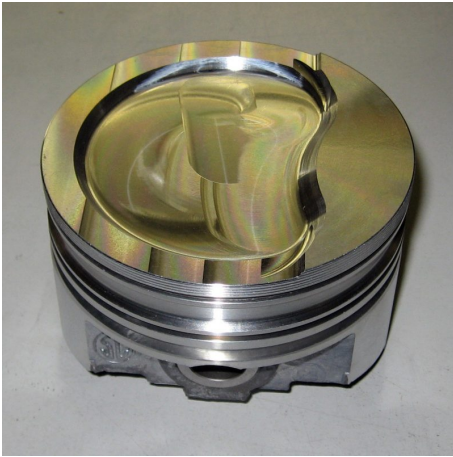

RB53116 KEITH BLACK PISTONS 9.8:1 FOR 472 W/76CC HEADS 1968-1973

SKU: RB53116

Keith Black Hypereutectic Piston 9.8:1 (76cc heads) 472CID .030,.040 & .060 fits 1968-1973

[Read More](#)

Price: ~~\$781.12~~ \$660.09



RB53114 KEITH BLACK 10:1 PISTONS FOR 500CID

SKU: RB53114

[Read More](#)

Price: \$695.00

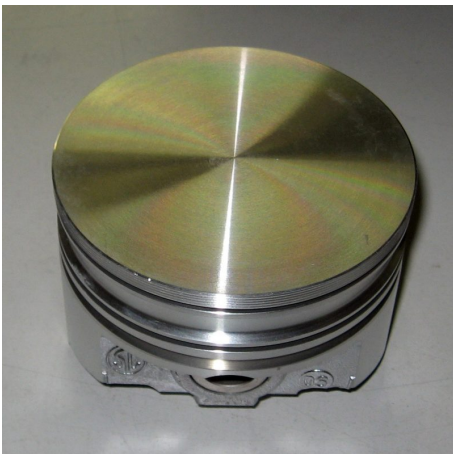

RB53111 KEITH BLACK FLAT TOP PISTONS 1974-1976

SKU: rb53111

[Read More](#)

Price: ~~\$738.88~~ \$624.31



RB51131 472 PISTONS 10:1 COMP RATIO W/76CC HEADS

SKU: RB51131

[Read More](#)

Price: \$575.00



RB51120 CAST REPLACEMENT PISTONS WITH PINS FOR CADILLAC 472 AND 500 ENGINES

SKU: RB51120

Cast replacement pistons for Cadillac 472 and 500 Engines, with pins
Available in standard (STD), .020", .030", .040", and .060" over bore sizes.

[Read More](#)

Price: \$550.00



RB51110 SILVOLITE CAST REPLACEMENT PISTONS WITH PINS FOR CADILLAC 472, 500, AND 425 ENGINES

SKU: RB51110

Silvolite cast replacement pistons for Cadillac 472, 500, and 425
Engines, with pins.
Available in standard (STD), .020", .030", .040", and .060" over bore sizes.

[Read More](#)

Price: \$595.00

RB40111 CRANK KEY

SKU: RB40111

Crankshaft key for timing gear / crank hub for Cadillac 472 / 500 / 425 / 368 engines. The correct factory style key. Nothing special, just the right thing.

[Read More](#)

Price: \$6.00



RB35112 HD FORGED H BEAM RODS

SKU: RB35112

Set of 8 new heavy-duty forged I-beam rods, w/ 7/16" cap screws and bushed for floating pins.

Recommended for N/A or boosted engines over 700 HP.

[Read More](#)

Price: \$695.00



RB33113 HD FORGED I BEAM RODS

SKU: RB33113

Set of 8 new heavy-duty forged I-beam rods, w/ 7/16" cap screws and bushed for floating pins.

Recommended for engines over 700 HP.

[Read More](#)

Price: \$595.00



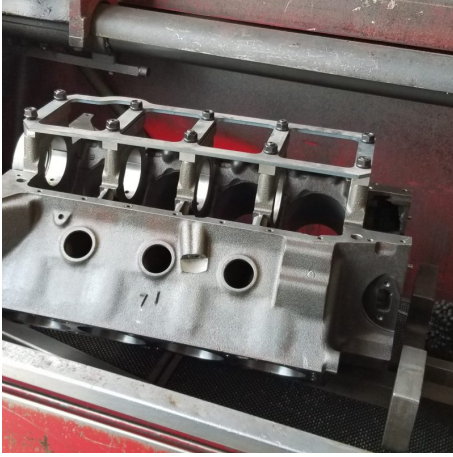

RB19123 MAIN GIRDLE KIT WITH CAP SUPPORTS

SKU: RB19123

Halo main girdle kit with cap supports

[Read More](#)

Price: \$499.00

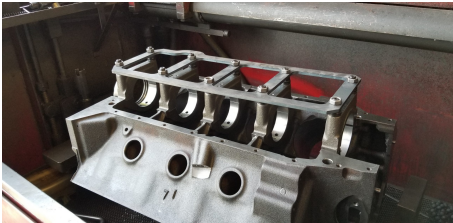

RB19121 HALO MAIN GIRDLE KIT

SKU: RB19121

Halo main girdle kit

[Read More](#)

Price: \$350.00



PB12306 HARMONIC DAMPER W/ HUB, SFI CERTIFIED

SKU: PB12306

SFI Certified One-Piece Harmonic Vibration Damper

[Read More](#)

Price: \$390.00

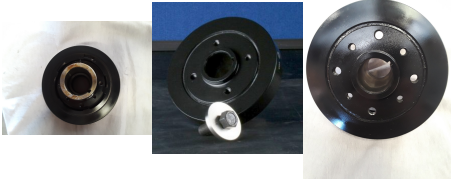

PB11202 BILLET STEEL CRANK HUB (OFFSET)

SKU: PB11202

Offset Billet Steel Crank Hub

This hub has offset flange spacing for correct pulley alignment using non-dampener pulleys with aftermarket performance dampeners that go between the pulley and hub, with the standard 4-bolt pulley pattern. This hub fits all 472 / 500 / 425 / 368 engines, and maintains the correct press-fit.

[Read More](#)

Price: \$190.00

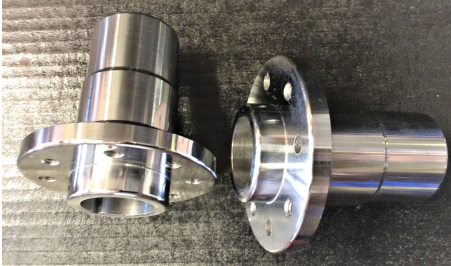

PB11201 BILLET STEEL CRANK HUB

SKU: PB11201

Standard Replacement Billet Steel Crank Hub

This hub is a direct replacement for the stock crank hub, in tougher billet steel form. Suitable for any application for which the factory hub will fit, but you need a replacement (due to a lost or damaged factory hub), or something tougher. This hub fits all 472 / 500 / 425 / 368 engines, and maintains the correct press-fit.

[Read More](#)

Price: \$250.00



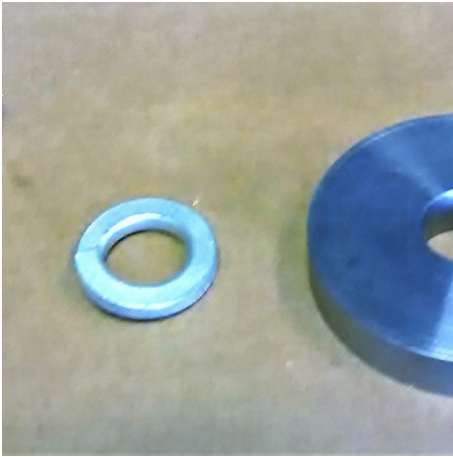

PB11122 CRANK HUB BOLT AND WASHER KIT

SKU: PB11122

Crank Hub Bolt and Washer Kit Correct washer to clear the pulley. Fits the front of the crankshaft, to positively retain the crank hub or damper (or dampener or balancer, as some folks call them).

[Read More](#)

Price: \$15.00



PB11113 CRANK HUB SLEEVE

SKU: PB11113

Crank hub sealing surface repair sleeve.

[Read More](#)

Price: \$95.00

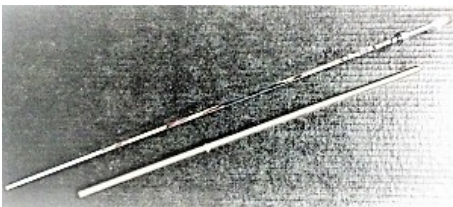

OS40220 DIPSTICK TUBE POLISHED STAINLESS STEEL W/ CHROME DIPSTICK

SKU: OS40220

Dipstick Tube Polished stainless steel with chrome dipstick

[Read More](#)

Price: \$75.00

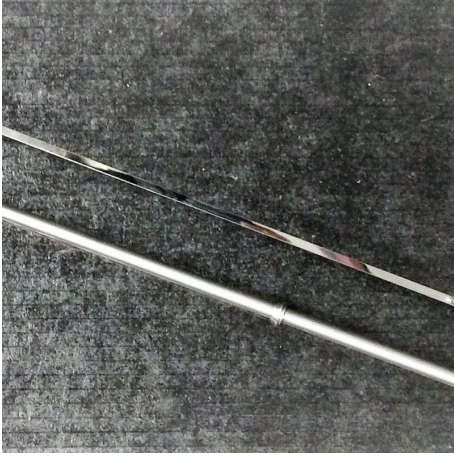

OS40210 DIPSTICK TUBE STAINLESS STEEL W/ CHROME DIPSTICK

SKU: OS40210

Dipstick Tube Stainless steel with chrome dipstick

[Read More](#)

Price: \$49.00

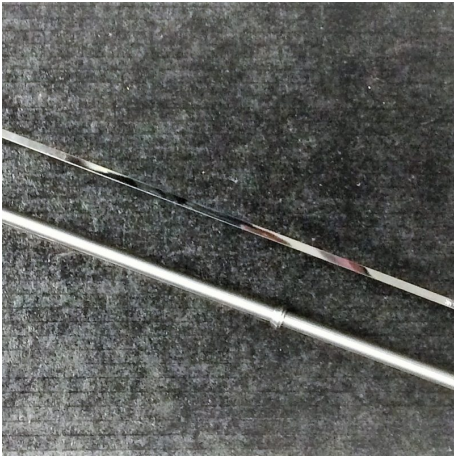

OS40110 DIPSTICK TUBE CHROME W/ CHROME DIPSTICK

SKU: OS40110

Dipstick Tube chrome with chrome dipstick

[Read More](#)

Price: \$45.00



OS40010 DIPSTICK TUBE UNIVERSAL, OE

SKU: OS40010

Universal, OE

[Read More](#)

Price: \$100.00



OS10151 CRANK SCRAPER

SKU: OS10151

[Read More](#)

Price: \$55.00



OL21101 ASSEMBLY LUBE: CLEVITE™ BEARING GUARD

SKU: OL21101

8 oz. Assembly Lube: Clevite™ Bearing Guard

[Read More](#)

Price: \$13.50

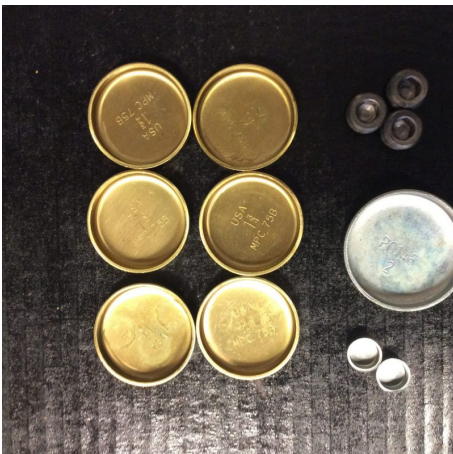

BH15301 FREEZE PLUG KIT (STANDARD) BRASS

SKU: BH15301

Brass

[Read More](#)

Price: \$26.00



BH15001 FREEZE PLUG KIT (STANDARD) STEEL

SKU: BH15001

Steel

[Read More](#)

Price: \$15.00



BH13143 OIL GALLEY THREADED PLUG

SKU: BH13143

3/8" Pipe Thread Plugs

3-4 per engine - rear of main oil galleys, oil pressure access port above oil pump, and coolant port just below thermostat housing.

[Read More](#)

Price: \$0.40

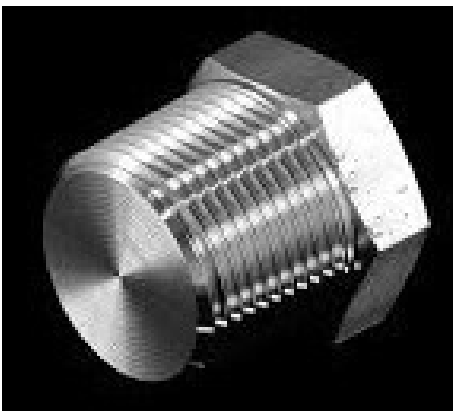

BH13091 HEAD COOLANT PLUG, THREADED

SKU: xBH13091

Head Coolant Plug, Threaded

[Read More](#)

Price: \$10.50

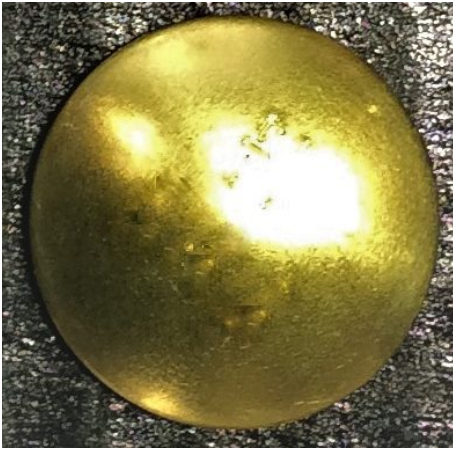

BH12396 HEAD COOLANT PLUG, DISC STYLE, BRASS

SKU: BH12396

Brass Disc Style Head Coolant Plug

[Read More](#)

Price: \$3.78



BH12096 HEAD COOLANT PLUG, DISC STYLE STEEL

SKU: BH12096

Head Coolant Plug, Disc Style Steel

[Read More](#)

Price: \$0.90



BH11X93 BLOCK EXPANSION PLUGS (STEEL OR BRASS)

SKU: BH11X93

Block Expansion Plugs (each)

req. 6 per engine

[Read More](#)

Price: \$0.75 - \$3.50



BH11394 HEAD COOLANT PLUG, CUP STYLE BRASS

SKU: BH11394

Brass Cup Style Head Coolant Plug (1 ea)

[Read More](#)

Price: \$2.93



BH11392 REAR CAM PLUG BRASS

SKU: BH11392

Brass

[Read More](#)

Price: \$5.00



BH11094 HEAD COOLANT PLUG, CUP STYLE STEEL

SKU: BH11094

Steel Cup Style Head Coolant Plug (1 ea)

[Read More](#)

Price: \$1.25



BH11092 REAR CAM PLUG STEEL

SKU: BH11092

Steel

[Read More](#)

Price: \$0.95



BH11091 SMOG PASSAGE PRESS IN PLUGS

SKU: BH11091

Smog Passage Press In Plugs

4 per engine

[Read More](#)

Price: \$0.75

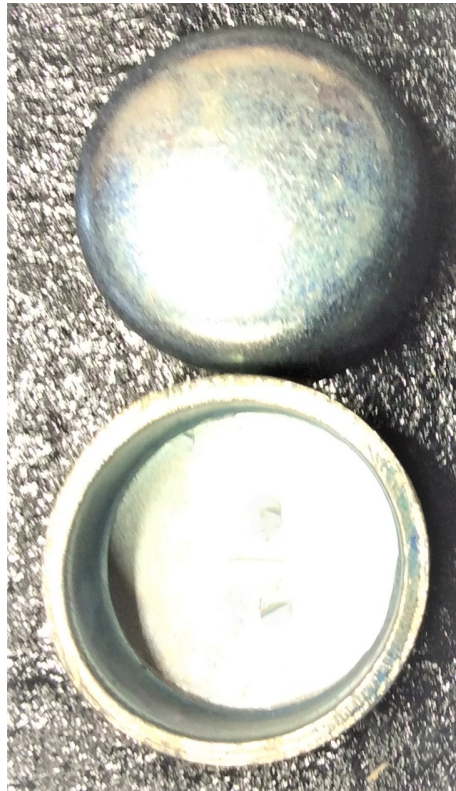

BH11081 OIL GALLEY PRESS IN PLUGS

SKU: BH11081

Oil Galley Press In Plugs

[Read More](#)

Price: \$0.40



BH11011 CAD COMPANY BLOCK HARDWARE KIT

SKU: BH11011

Includes freeze plugs (brass), cam plug, all 7 galley plugs, 4 brass disc type head freeze plugs, 2 smog rail plugs, and block/ head dowel pins.

[Read More](#)

Price: \$53.72

HARDWARE

Stock heads will have 3 plugs per head. Read
More >>

2 per head will be the disc type (the hole will have a step so the plug can only go in so far). The third head plug will be one of the following:

- Disc style plug like the other 2 (mostly '68-'69 engines).
- The press in cup style (like a standard freeze plug) (some '68-'69 engines and 425 / 368 heads).

The 425 and most 368 heads will have one plug and one press in 90° heater outlet (no longer available) from the factory.

- Threaded head plugs (pipe thread) - usually one plug and one straight heater outlet (most '70-'76 engines)

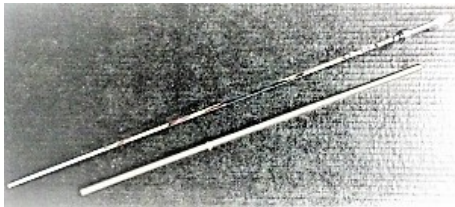

OS40220 DIPSTICK TUBE POLISHED STAINLESS STEEL W/ CHROME DIPSTICK

SKU: OS40220

Dipstick Tube Polished stainless steel with chrome dipstick

[Read More](#)

Price: \$75.00

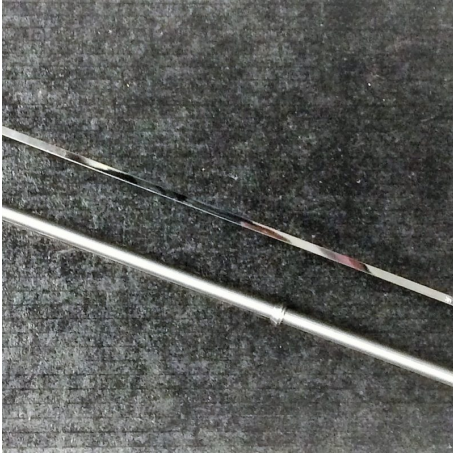

OS40210 DIPSTICK TUBE STAINLESS STEEL W/ CHROME DIPSTICK

SKU: OS40210

Dipstick Tube Stainless steel with chrome dipstick

[Read More](#)

Price: \$49.00

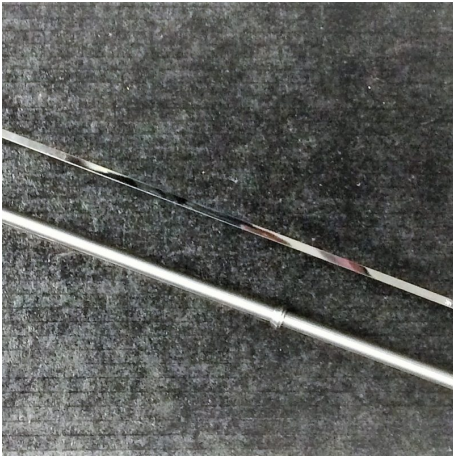

OS40110 DIPSTICK TUBE CHROME W/ CHROME DIPSTICK

SKU: OS40110

Dipstick Tube chrome with chrome dipstick

[Read More](#)

Price: \$45.00



OS40010 DIPSTICK TUBE UNIVERSAL, OE

SKU: OS40010

Universal, OE

[Read More](#)

Price: \$100.00

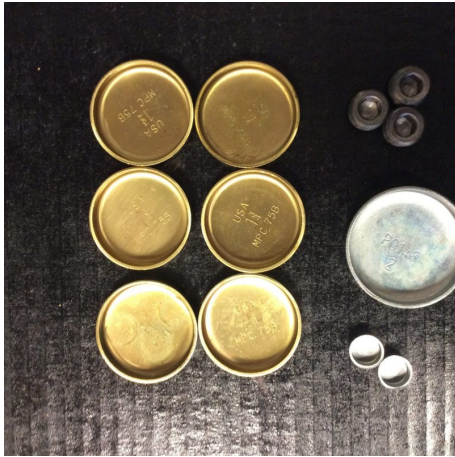

BH15301 FREEZE PLUG KIT (STANDARD) BRASS

SKU: BH15301

Brass

[Read More](#)

Price: \$26.00



BH15001 FREEZE PLUG KIT (STANDARD) STEEL

SKU: BH15001

Steel

[Read More](#)

Price: \$15.00



BH13143 OIL GALLEY THREADED PLUG

SKU: BH13143

3/8" Pipe Thread Plugs

3-4 per engine - rear of main oil galleys, oil pressure access port above oil pump, and coolant port just below thermostat housing.

[Read More](#)

Price: \$0.40

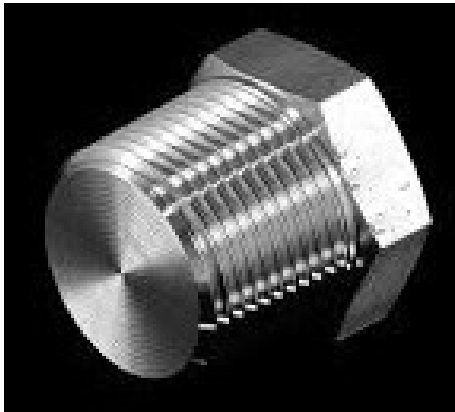

BH13091 HEAD COOLANT PLUG, THREADED

SKU: xBH13091

Head Coolant Plug, Threaded

[Read More](#)

Price: \$10.50

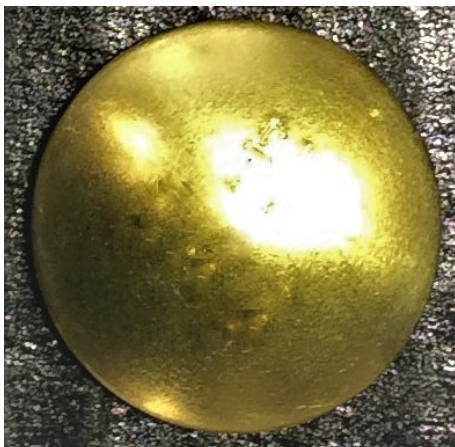

BH12396 HEAD COOLANT PLUG, DISC STYLE, BRASS

SKU: BH12396

Brass Disc Style Head Coolant Plug

[Read More](#)

Price: \$3.78



BH12096 HEAD COOLANT PLUG, DISC STYLE STEEL

SKU: BH12096

Head Coolant Plug, Disc Style Steel

[Read More](#)

Price: \$0.90



BH11X93 BLOCK EXPANSION PLUGS (STEEL OR BRASS)

SKU: BH11X93

Block Expansion Plugs (each)

req. 6 per engine

[Read More](#)

Price: \$0.75 - \$3.50



BH11394 HEAD COOLANT PLUG, CUP STYLE BRASS

SKU: BH11394

Brass Cup Style Head Coolant Plug (1 ea)

[Read More](#)

Price: \$2.93



BH11392 REAR CAM PLUG BRASS

SKU: BH11392

Brass

[Read More](#)

Price: \$5.00



BH11094 HEAD COOLANT PLUG, CUP STYLE STEEL

SKU: BH11094

Steel Cup Style Head Coolant Plug (1 ea)

[Read More](#)

Price: \$1.25



BH11092 REAR CAM PLUG STEEL

SKU: BH11092

Steel

[Read More](#)

Price: \$0.95



BH11091 SMOG PASSAGE PRESS IN PLUGS

SKU: BH11091

Smog Passage Press In Plugs

4 per engine

[Read More](#)

Price: \$0.75



BH11081 OIL GALLEY PRESS IN PLUGS

SKU: BH11081

Oil Galley Press In Plugs

[Read More](#)

Price: \$0.40



BH11011 CAD COMPANY BLOCK HARDWARE KIT

SKU: BH11011

Includes freeze plugs (brass), cam plug, all 7 galley plugs, 4 brass disc type head freeze plugs, 2 smog rail plugs, and block/ head dowel pins.

[Read More](#)

Price: \$53.72

RINGS AND BEARINGS

Here at Cad Company, we have torture tested a variety of different rings and bearings under a wide range of conditions. In some cases, a specific product *is* recommended over others - but not always what you'd expect.

Our Policy - We only sell rings and bearings that we use in our turn-key engines, and are willing to stand behind with one of the best warranties in the crate engine business.

Brands - In our experience, there is not any real benefit of one brand over another in most cases (and many of them are the same parts in a different box, anyway) - we simply don't offer the ones you don't want. Some sizes are only available in 1 or 2 brands. If you want a specific brand, we would be happy to accommodate you (if they are available in the size you need), but be aware that specifying a brand may result in a higher price, as we don't have the benefit of negotiating the best price for a volume order.

Cam Bearings - Cam bearings are not all created equal. Durabond bearings are the best choice for most builds, but there are situations where something different is called for. The Cad Company exclusive grooved cam bearings (pictured) are made to our specs by Durabond. They incorporate a groove around the outside to allow oil to flow around the the second hole, which allows oil to enter the bearing on the loaded side, decreasing the chance of bearing failure due to high spring pressure. They also have an oil clearance closer to the middle of the factory spec, instead of tighter like the other off-the-shelf bearings, eliminating the need to clearance the bearings during assembly. If you have a problem with the cam bearings 'smearing', these bearings are probably the solution.

Rod and Main Bearings - There are 2 'series' of bearings available for rod bearings - 'P' and 'H'. 'H' bearings are generally intended for race cars. They are a harder alloy, and will survive more abuse in the way of things like being hammered on by detonation, but they tend to result in increased crankshaft wear due to reduced embeddability. 'Embeddability' is the property of bearings where contaminants embed into the bearing material, and reduced embeddability means that those contaminants stay on the surface, where they can scratch the

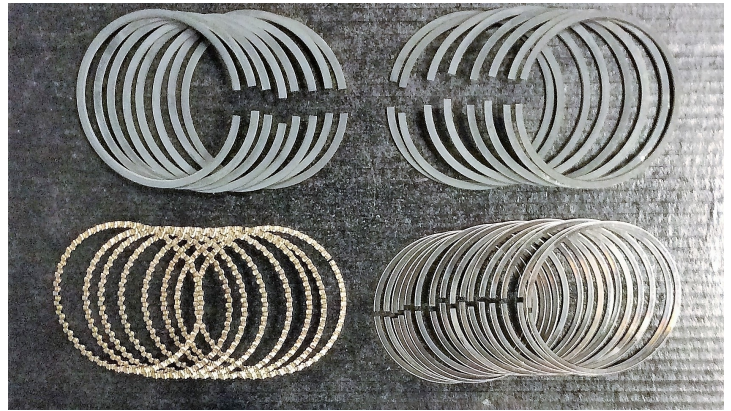

crankshaft. We do not recommend 'H' series bearings for anything but the most extreme drag racing applications.

Coatings - There is a lot of contradictory information out there about the various bearing coatings available. We have not been able to verify any of these claims on dyno test engines. At this time, we do not offer coated bearings.

Rings - We prefer moly rings for most N/A applications. They seat quick, last quite well, and are (relatively) reasonably priced. Care should be taken when selecting rings - check the piston description for special ring requirements before ordering. Also, be sure to check the instructions for ring end gap that come with your pistons - those usually take precedence over recommendations found elsewhere. When in doubt, ask.



RB77102 CAM BEARINGS, CC3 GROOVED / DUAL HOLE STYLE

SKU: RB77102

Cam Bearings, CC3 grooved / dual hole style

[Read More](#)

Price: \$116.60



RB77101 CAM BEARINGS, STOCK REPLACEMENT

SKU: RB77101

Cam bearings, stock replacement style

[Read More](#)

Price: \$52.28



RB75110 CLEVITE 'H' SERIES ROD BEARINGS

SKU: RB75110

Clevite™ 'H' series rod bearings. Set of 8 pairs.

Recommended for competition use only.

[Read More](#)

Price: \$220.00



RB75100 ROD BEARINGS FOR 472 / 500 / 425 / 368

SKU: RB75100

Rod Bearings - set of 8 pairs for 472 / 500 / 425 / 368.

[Read More](#)

Price: \$187.20

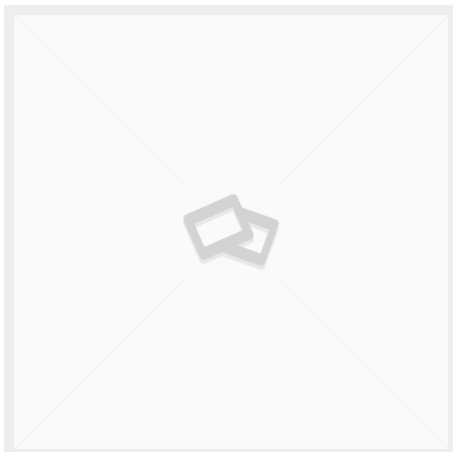

RB73101 ROD AND MAIN BEARING KIT FOR 472 / 500 / 425 / 368

SKU: RB73101

Rod and main bearing kit for 472 / 500 / 425 / 368.

Includes: Main Bearings, set of 5 pairs, Rod bearings set of 8 pairs.

[Read More](#)

Price: \$402.93 ~~\$362.64~~



RB71100 MAIN BEARINGS FOR 472 / 500 / 425 / 368

SKU: RB71100

Main Bearings, set of 5 pairs, for 472 / 500 / 425 / 368.

[Read More](#)

Price: \$215.73



RB59170 PISTON RING SET FOR 425

SKU: RB59170

Piston rings for 425 engines.
Standard width (5/64" / 5/64" / 3/16").

Complete set (1 set per engine).

We recommend Moly rings for most builds.

[Read More](#)

Price: \$105.17 - \$219.43

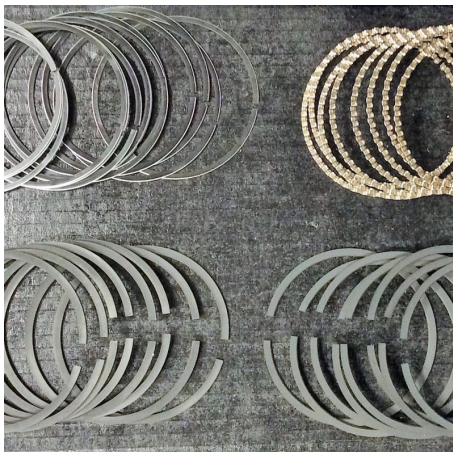

RB59115 SKINNY (1/16") MOLY PISTON RING SET FOR 472 / 500 FOR CAD COMPANY FORGED PISTONS

SKU: RB59115

'Skinny' Piston rings for 472 / 500 engines with Cad Company forged pistons.
Narrow width (1/16" / 1/16" / 3/16") - These rings ONLY fit forged pistons intended for skinny rings. Not applicable to stock replacement or KB pistons, or most forged pistons aside from the current Cad Company off-the-shelf forged pistons or something custom-made-to-order for these rings.

Complete set (1 set per engine).

Only available in Moly, and only available in the sizes listed.

[Read More](#)

Price: \$219.43

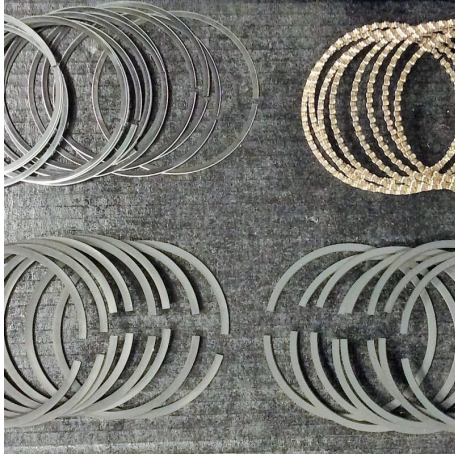

RB59110 PISTON RING SET FOR 472 / 500

SKU: RB59110

Piston rings for 472 / 500 engines.
Standard width (5/64" / 5/64" / 3/16") - for any off-the-shelf piston that does not specify narrow rings.

Complete set (1 set per engine).

We recommend Moly rings for most builds.

[Read More](#)

Price: \$120.00 - \$197.20



OL21101 ASSEMBLY LUBE: CLEVITE™ BEARING GUARD

SKU: OL21101

8 oz. Assembly Lube: Clevite™ Bearing Guard

[Read More](#)

Price: \$13.50

ROTATING PARTS

Rotating Parts



RB55472 10:1 FORGED PISTONS - 472 CID W/ 76CC HEADS - D-DISH

SKU: RB55472

Cad Company forged pistons - D-Dish - 10:1 compression for 472 CID Cadillac engines with 76cc heads. With coated skirts. Price includes pins. Valve reliefs clear iron and aluminum heads. Uses 1/16" ring pack for reduced friction. Made in USA

[Read More](#)

Price: \$750.00



RB55176 9:1 FORGED PISTONS - 500 CID - FLAT TOP

SKU: RB55176

Cad Company forged pistons - Flat Top - 9:1 compression for 500 CID Cadillac engines with 120cc heads (or 13:1 w/ 76cc heads). With coated skirts. Price includes pins. No valve reliefs. Uses 1/16" ring pack for reduced friction. Made in USA

[Read More](#)

Price: \$750.00



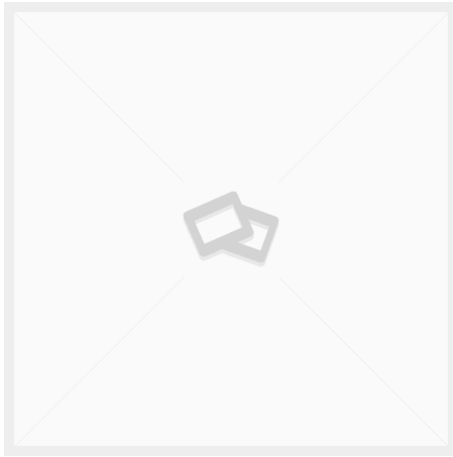

RB55174 10:1 FORGED PISTONS - 500 CID W/ 120CC HEADS - DOMED

SKU: RB55174

Cad Company forged pistons - D-Dish - 10:1 compression for 500 CID Cadillac engines with 120cc heads, or 14:1 compression for 500 CID Cadillac engines with 76cc OE or ported OE heads. With coated skirts. Price includes pins. Valve reliefs clear iron and aluminum heads. Uses 1/16" ring pack for reduced friction. Made in USA

[Read More](#)

Price: \$750.00



RB55172 10:1 FORGED PISTONS - 500 CID W/ 76CC HEADS - D-DISH

SKU: RB55172

Cad Company forged pistons - D-Dish - 10:1 compression for 500 CID Cadillac engines with 76cc heads. With coated skirts. Price includes pins. Valve reliefs clear iron and aluminum heads. Uses 1/16" ring pack for reduced friction. Made in USA

[Read More](#)

Price: \$750.00

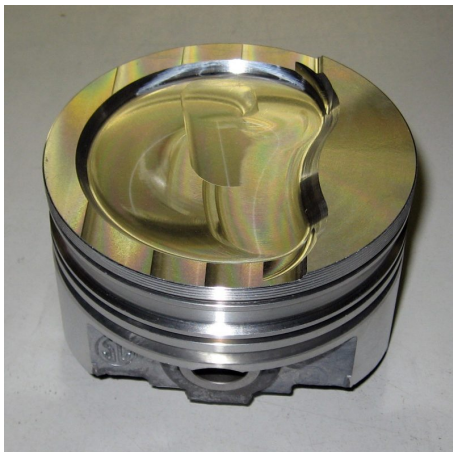

RB53116 KEITH BLACK PISTONS 9.8:1 FOR 472 W/76CC HEADS 1968-1973

SKU: RB53116

Keith Black Hypereutectic Piston 9.8:1 (76cc heads) 472CID .030,.040 & .060 fits 1968-1973

[Read More](#)

Price: \$781.12 \$660.09

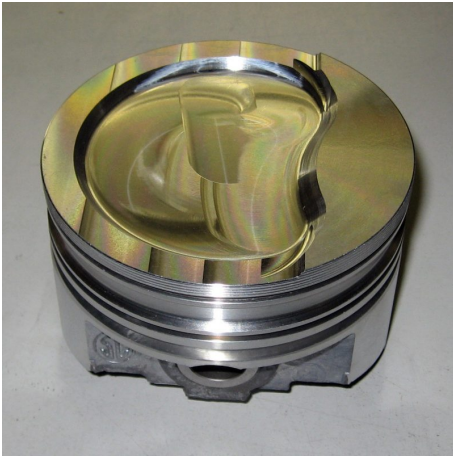

RB53114 KEITH BLACK 10:1 PISTONS FOR 500CID

SKU: RB53114

[Read More](#)

Price: \$695.00

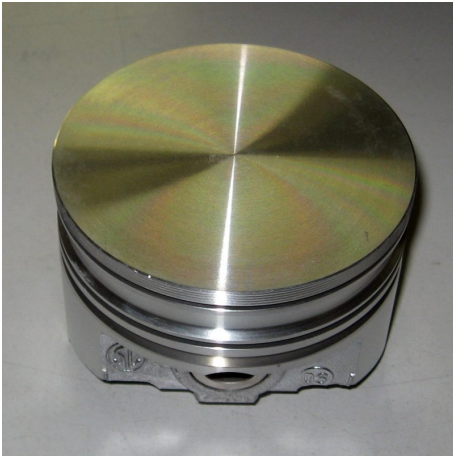

RB53111 KEITH BLACK FLAT TOP PISTONS 1974-1976

SKU: rb53111

[Read More](#)

Price: ~~\$738.88~~ \$624.31



RB51131 472 PISTONS 10:1 COMP RATIO W/76CC HEADS

SKU: RB51131

[Read More](#)

Price: \$575.00



RB51120 CAST REPLACEMENT PISTONS WITH PINS FOR CADILLAC 472 AND 500 ENGINES

SKU: RB51120

Cast replacement pistons for Cadillac 472 and 500 Engines, with pins. Available in standard (STD), .020", .030", .040", and .060" over bore sizes.

[Read More](#)

Price: \$550.00



RB51110 SILVOLITE CAST REPLACEMENT PISTONS WITH PINS FOR CADILLAC 472, 500, AND 425 ENGINES

SKU: RB51110

Silvolite cast replacement pistons for Cadillac 472, 500, and 425 Engines, with pins. Available in standard (STD), .020", .030", .040", and .060" over bore sizes.

[Read More](#)

Price: \$595.00

RB40111 CRANK KEY

SKU: RB40111

Crankshaft key for timing gear / crank hub for Cadillac 472 / 500 / 425 / 368 engines. The correct factory style key. Nothing special, just the right thing.

[Read More](#)

Price: \$6.00





RB35112 HD FORGED H BEAM RODS

SKU: RB35112

Set of 8 new heavy-duty forged I-beam rods, w/ 7/16" cap screws and bushed for floating pins.

Recommended for N/A or boosted engines over 700 HP.

[Read More](#)

Price: \$695.00



RB33113 HD FORGED I BEAM RODS

SKU: RB33113

Set of 8 new heavy-duty forged I-beam rods, w/ 7/16" cap screws and bushed for floating pins.

Recommended for engines over 700 HP.

[Read More](#)

Price: \$595.00

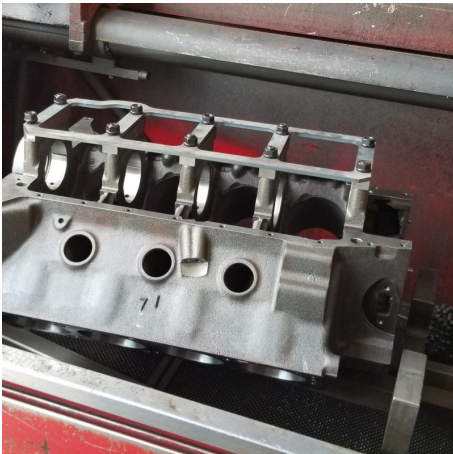

RB19123 MAIN GIRDLE KIT WITH CAP SUPPORTS

SKU: RB19123

Halo main girdle kit with cap supports

[Read More](#)

Price: \$499.00

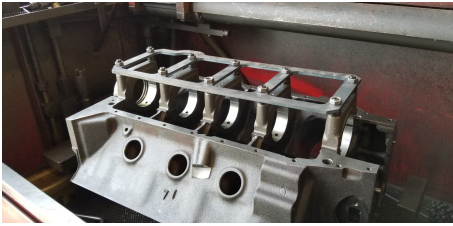

RB19121 HALO MAIN GIRDLE KIT

SKU: RB19121

Halo main girdle kit

[Read More](#)

Price: \$350.00



PB12306 HARMONIC DAMPER W/ HUB, SFI CERTIFIED

SKU: PB12306

SFI Certified One-Piece Harmonic Vibration Damper

[Read More](#)

Price: \$390.00

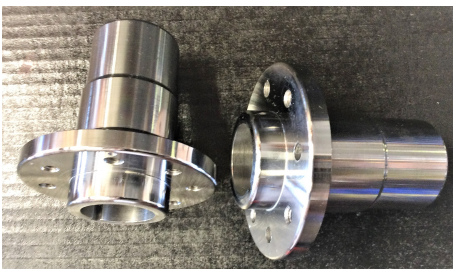
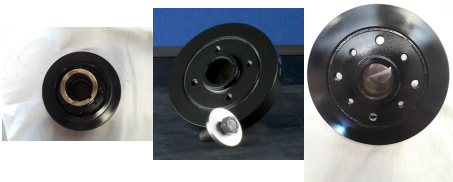

PB11202 BILLET STEEL CRANK HUB (OFFSET)

SKU: PB11202

Offset Billet Steel Crank Hub

This hub has offset flange spacing for correct pulley alignment using non-dampener pulleys with aftermarket performance dampeners that go between the pulley and hub, with the standard 4-bolt pulley pattern. This hub fits all 472 / 500 / 425 / 368 engines, and maintains the correct press-fit.

[Read More](#)

Price: \$190.00

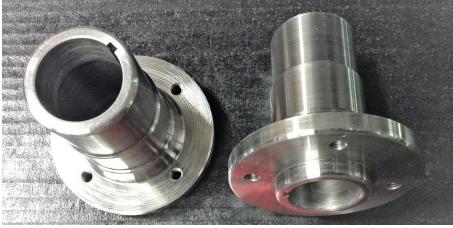

PB11201 BILLET STEEL CRANK HUB

SKU: PB11201

Standard Replacement Billet Steel Crank Hub

This hub is a direct replacement for the stock crank hub, in tougher billet steel form. Suitable for any application for which the factory hub will fit, but you need a replacement (due to a lost or damaged factory hub), or something tougher. This hub fits all 472 / 500 / 425 / 368 engines, and maintains the correct press-fit.

[Read More](#)

Price: \$250.00

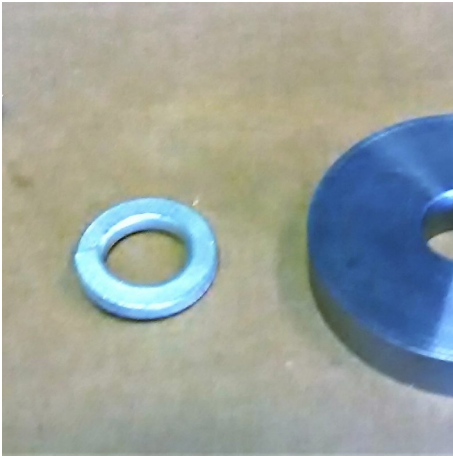

PB11122 CRANK HUB BOLT AND WASHER KIT

SKU: PB11122

Crank Hub Bolt and Washer Kit Correct washer to clear the pulley. Fits the front of the crankshaft, to positively retain the crank hub or damper (or dampener or balancer, as some folks call them).

[Read More](#)

Price: \$15.00



PB11113 CRANK HUB SLEEVE

SKU: PB11113

Crank hub sealing surface repair sleeve.

[Read More](#)

Price: \$95.00



OS10151 CRANK SCRAPER

SKU: OS10151

[Read More](#)

Price: \$55.00

CRANKSHAFTS, STROKER KITS, CRANK HUBS, AND VIBRATION DAMPENERS

Crankshafts, Stroker Kits, Crank Hubs, and
Vibration Dampeners [Read More >>](#)

Cad Company does not sell stroked stock cranks by themselves - we only sell them as complete rotating assemblies. We do sell reconditioned and machined stock cranks, ready to install and aftermarket billet cranks (the same ones in our billet crank stroker kits, as well as made-to order).

Cad Company's stroker kits utilizing stroked stock cranks incorporate all that we have learned over 40+ years of building performance Cadillac engines, and our current recipe has been torture tested to nearly 2k HP. Most home-brew stroker cranks fail sooner or later (usually sooner) on engines making any real power - it's not as simple to build a reliable stroker crank as some would have you believe, but we have worked out the details to offer you a reasonably priced rotating assembly, without having to go through the trial and error method of figuring out what fails and what doesn't.

We offer 2 crank hub options. In most cases you will want the 'standard' hub. The offset hub was primarily for pulley alignment with an obsolete (no longer available) aftermarket dampener. Most '73-older (3-groove) factory pulleys are back-cut to provide clearance for the factory vibration dampener. Some '73-older and most '74-newer (2-groove) factory pulleys, as well as all aftermarket pulleys, are not. All factory hubs have the same spacing, and that's what the 'standard' dampener matches. If you want to use the factory dampener with a late or aftermarket pulley, the offset hub is your best bet, but it will generally require manually shimming the pulley for proper belt alignment (with a stock or standard replacement hub, you would have to machine the clearance into the back of the pulley, IF the pulley you are using has room to do so). You cannot simply use the offset hub and pull the hub outward for belt alignment, as the hub must be pressed on as far as it will go - there are a variety of likely failures if the hub is not pressed on all the way, it's just a matter of what fails first.

The only vibration dampener currently available is sold as a complete unit, with it's own unique hub (pre-assembled together). The



mounting face provides the same pulley alignment as the factory and 'standard' replacement hubs.

RB40111 CRANK KEY

SKU: RB40111

Crankshaft key for timing gear / crank hub for Cadillac 472 / 500 / 425 / 368 engines. The correct factory style key. Nothing special, just the right thing.

[Read More](#)

Price: \$6.00

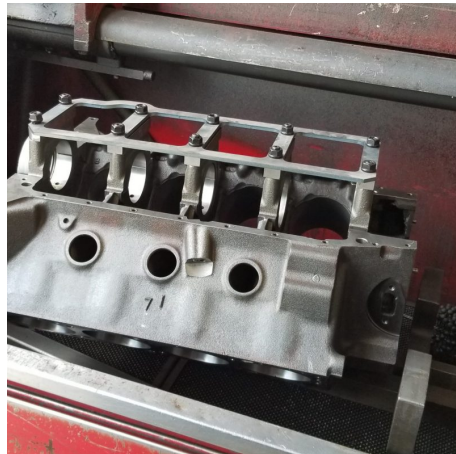

RB19123 MAIN GIRDLE KIT WITH CAP SUPPORTS

SKU: RB19123

Halo main girdle kit with cap supports

[Read More](#)

Price: \$499.00

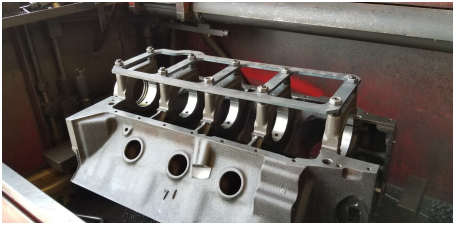

RB19121 HALO MAIN GIRDLE KIT

SKU: RB19121

Halo main girdle kit

[Read More](#)

Price: \$350.00



PB12306 HARMONIC DAMPER W/ HUB, SFI CERTIFIED

SKU: PB12306

SFI Certified One-Piece Harmonic Vibration Damper

[Read More](#)

Price: \$390.00

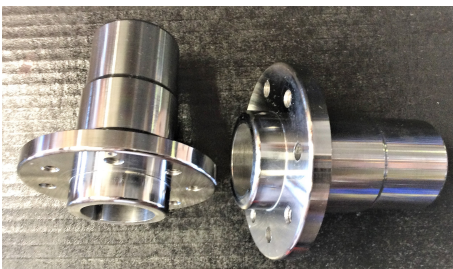
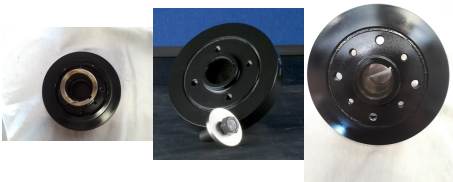

PB11202 BILLET STEEL CRANK HUB (OFFSET)

SKU: PB11202

Offset Billet Steel Crank Hub

This hub has offset flange spacing for correct pulley alignment using non-dampener pulleys with aftermarket performance dampeners that go between the pulley and hub, with the standard 4-bolt pulley pattern. This hub fits all 472 / 500 / 425 / 368 engines, and maintains the correct press-fit.

[Read More](#)

Price: \$190.00

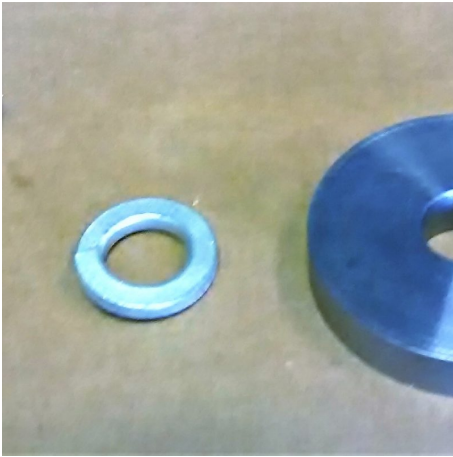

PB11122 CRANK HUB BOLT AND WASHER KIT

SKU: PB11122

Crank Hub Bolt and Washer Kit Correct washer to clear the pulley. Fits the front of the crankshaft, to positively retain the crank hub or damper (or dampener or balancer, as some folks call them).

[Read More](#)

Price: \$15.00



PB11113 CRANK HUB SLEEVE

SKU: PB11113

Crank hub sealing surface repair sleeve.

[Read More](#)

Price: \$95.00

MAIN STUDS, GIRDLES, AND SCRAPERS

Main bolts and studs, Main Girdles, and Crank
Scrapers

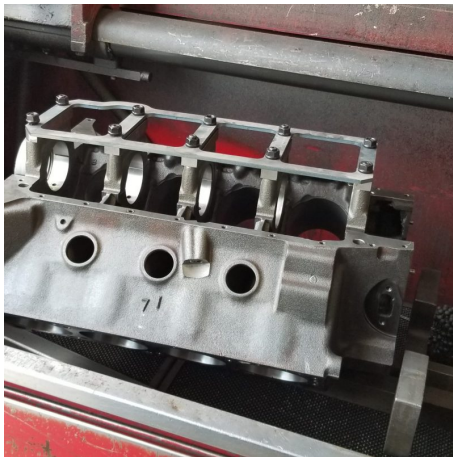

RB19123 MAIN GIRDLE KIT WITH CAP SUPPORTS

SKU: RB19123

Halo main girdle kit with cap supports

[Read More](#)

Price: \$499.00

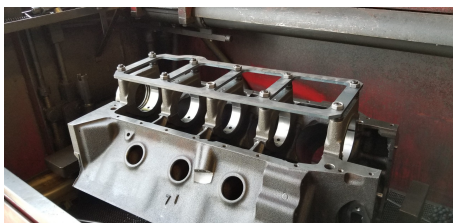

RB19121 HALO MAIN GIRDLE KIT

SKU: RB19121

Halo main girdle kit

[Read More](#)

Price: \$350.00



OS10151 CRANK SCRAPER

SKU: OS10151

[Read More](#)

Price: \$55.00

RODS AND PISTONS

Rod/ Piston Combos



RB55472 10:1 FORGED PISTONS - 472 CID W/ 76CC HEADS - D-DISH

SKU: RB55472

Cad Company forged pistons - D-Dish - 10:1 compression for 472 CID Cadillac engines with 76cc heads. With coated skirts. Price includes pins. Valve reliefs clear iron and aluminum heads. Uses 1/16" ring pack for reduced friction. Made in USA

[Read More](#)

Price: \$750.00



RB55176 9:1 FORGED PISTONS - 500 CID - FLAT TOP

SKU: RB55176

Cad Company forged pistons - Flat Top - 9:1 compression for 500 CID Cadillac engines with 120cc heads (or 13:1 w/ 76cc heads). With coated skirts. Price includes pins. No valve reliefs. Uses 1/16" ring pack for reduced friction. Made in USA

[Read More](#)

Price: \$750.00



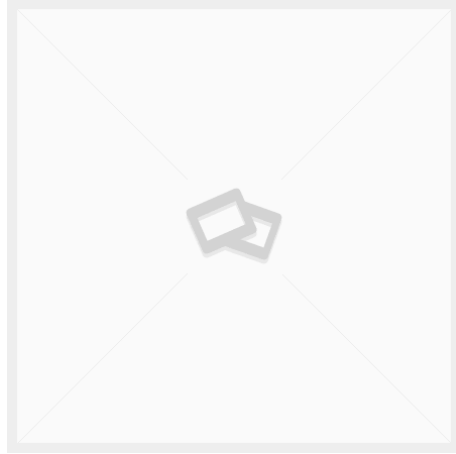

RB55174 10:1 FORGED PISTONS - 500 CID W/ 120CC HEADS - DOMED

SKU: RB55174

Cad Company forged pistons - D-Dish - 10:1 compression for 500 CID Cadillac engines with 120cc heads, or 14:1 compression for 500 CID Cadillac engines with 76cc OE or ported OE heads. With coated skirts. Price includes pins. Valve reliefs clear iron and aluminum heads. Uses 1/16" ring pack for reduced friction. Made in USA

[Read More](#)

Price: \$750.00



RB55172 10:1 FORGED PISTONS - 500 CID W/ 76CC HEADS - D-DISH

SKU: RB55172

Cad Company forged pistons - D-Dish - 10:1 compression for 500 CID Cadillac engines with 76cc heads. With coated skirts. Price includes pins. Valve reliefs clear iron and aluminum heads. Uses 1/16" ring pack for reduced friction. Made in USA

[Read More](#)

Price: \$750.00

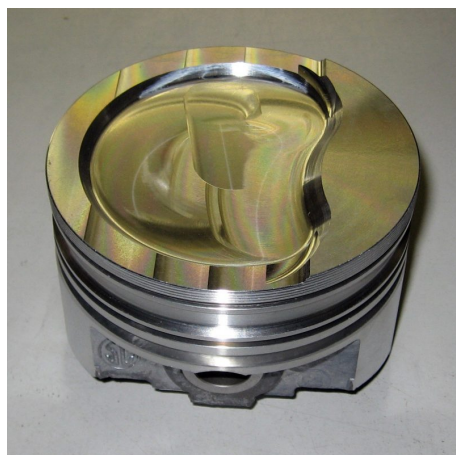

RB53116 KEITH BLACK PISTONS 9.8:1 FOR 472 W/76CC HEADS 1968-1973

SKU: RB53116

Keith Black Hypereutectic Piston 9.8:1 (76cc heads) 472CID .030,.040 & .060 fits 1968-1973

[Read More](#)

Price: \$781.12 \$660.09

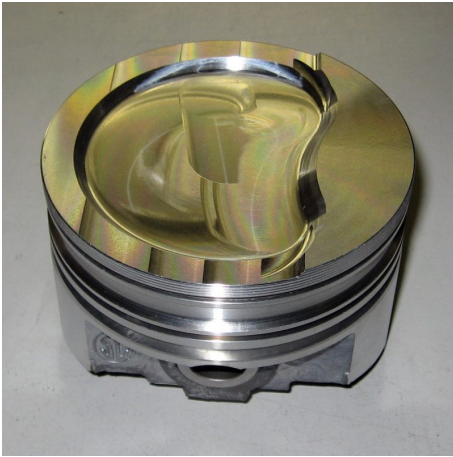

RB53114 KEITH BLACK 10:1 PISTONS FOR 500CID

SKU: RB53114

[Read More](#)

Price: \$695.00

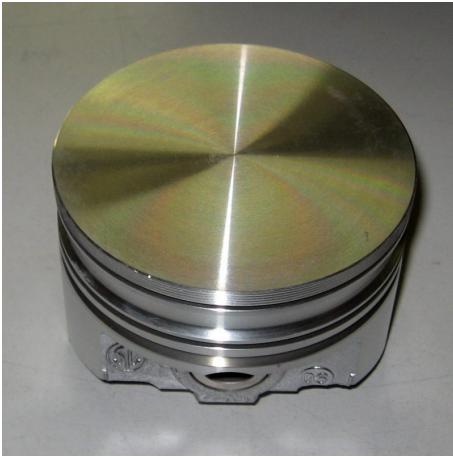

RB53111 KEITH BLACK FLAT TOP PISTONS 1974-1976

SKU: rb53111

[Read More](#)

Price: ~~\$738.88~~ \$624.31



RB51131 472 PISTONS 10:1 COMP RATIO W/76CC HEADS

SKU: RB51131

[Read More](#)

Price: \$575.00



RB51120 CAST REPLACEMENT PISTONS WITH PINS FOR CADILLAC 472 AND 500 ENGINES

SKU: RB51120

Cast replacement pistons for Cadillac 472 and 500 Engines, with pins Available in standard (STD), .020", .030", .040", and .060" over bore sizes.

[Read More](#)

Price: \$550.00



RB51110 SILVOLITE CAST REPLACEMENT PISTONS WITH PINS FOR CADILLAC 472, 500, AND 425 ENGINES

SKU: RB51110

Silvolite cast replacement pistons for Cadillac 472, 500, and 425 Engines, with pins. Available in standard (STD), .020", .030", .040", and .060" over bore sizes.

[Read More](#)

Price: \$595.00



RB35112 HD FORGED H BEAM RODS

SKU: RB35112

Set of 8 new heavy-duty forged I-beam rods, w/ 7/16" cap screws and bushed for floating pins.

Recommended for N/A or boosted engines over 700 HP.

[Read More](#)

Price: \$695.00

RB33113 HD FORGED I BEAM RODS

SKU: RB33113

Set of 8 new heavy-duty forged I-beam rods, w/ 7/16" cap screws and bushed for floating pins.

Recommended for engines over 700 HP.

[Read More](#)

Price: \$595.00



PULLEYS, BRACKETS AND ACCESSORIES

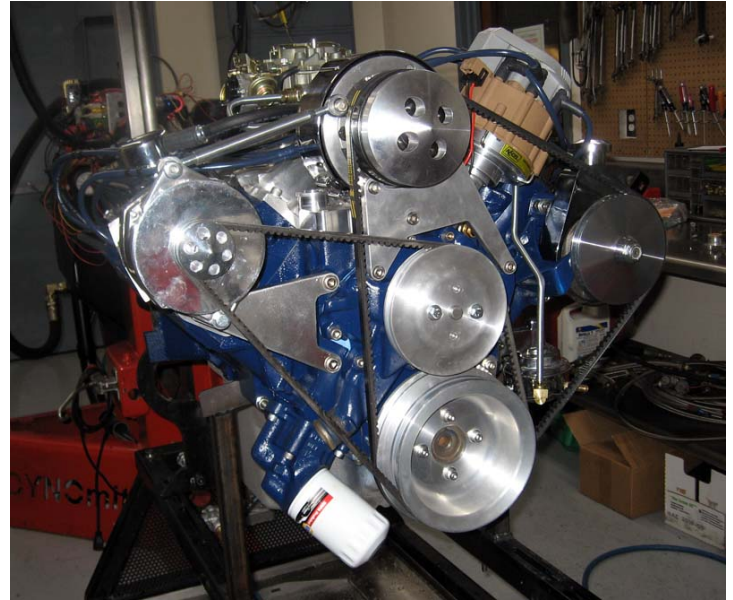

WS66103 ALTERNATOR WIRING CONVERSION KIT

SKU: WS66103

Alternator Wiring Conversion Kit

Plug-and-play kit for wiring a 3-wire (stock '73-up GM) internally regulated alternator, into vehicles original equipped with an externally regulated GM alternator (such as '62-'72 Cadillacs). Includes adapter plug for alternator and external-regulator-elimination-plug for the connector that used to plug into the external regulator.

[Read More](#)

Price: \$45.00

PB82821 6-RIB SERPENTINE ALTERNATOR BELT - SHORTER BELT FOR 'C'-TYPE BRACKET

SKU: PB82821

6-RIB SERPENTINE ALTERNATOR BELT

ALTERNATOR AND WATER PUMP BELT FOR CADCO SERPENTINE SYSTEM

This belt drives the alternator and water pump, and fits the [PB18763](#) (3-belt) serpentine pulley kit and the ProCharger kit, with mild steel or stainless steel 'C' type brackets.

[Read More](#)

Price: \$45.00

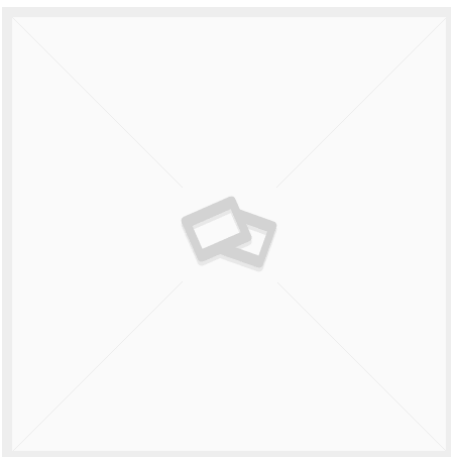

PB82820 6-RIB SERPENTINE ALTERNATOR BELT - STANDARD LENGTH

SKU: PB82820

6-RIB SERPENTINE ALTERNATOR BELT

ALTERNATOR AND WATER PUMP BELT FOR CADCO SERPENTINE SYSTEM

This belt drives the alternator and water pump, and fits the [PB18763](#) (3-belt) serpentine pulley kit and the ProCharger kit, with stock or billet aluminum alternator brackets.

[Read More](#)

Price: \$45.00

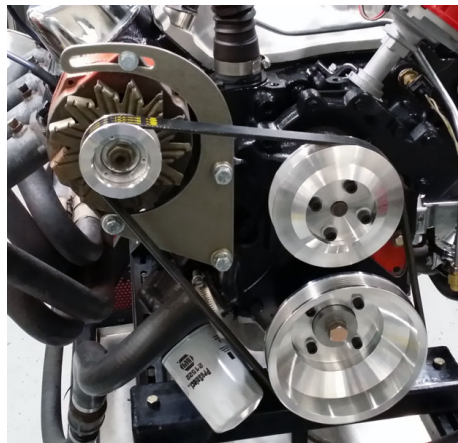

PB71773 SERPENTINE PULLEY AND BILLET BRACKET KIT WITH POLISHED ALUMINUM 140 AMP ALTERNATOR PB71773

SKU: PB71773

This kit includes billet aluminum crank and water pump pulleys, SS crank and water pump pulley bolts, our billet aluminum alternator bracket kit, and a polished aluminum 140-Amp 1-wire alternator with billet aluminum pulley.

Note: Includes polished alternator, rather than the un-chromed version in the picture.

[Read More](#)

Price: \$975.00

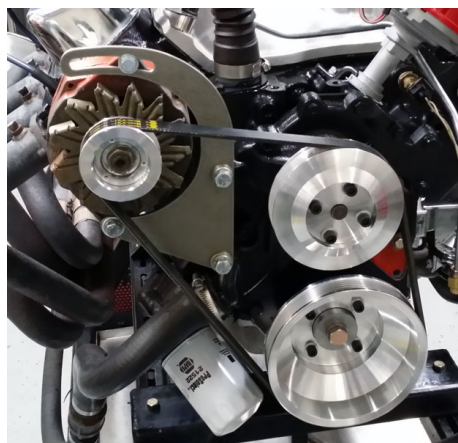

PB71772 SERPENTINE PULLEY AND BRACKET KIT WITH CHROME 105 AMP ALTERNATOR

SKU: PB71772

This kit includes billet aluminum crank and water pump pulleys, SS crank and water pump pulley bolts, our stainless alternator bracket kit, and a chrome 105-Amp 1-wire alternator with chrome pulley.

Note: Includes chrome alternator, rather than the un-chromed version in the picture.

[Read More](#)

Price: \$625.00

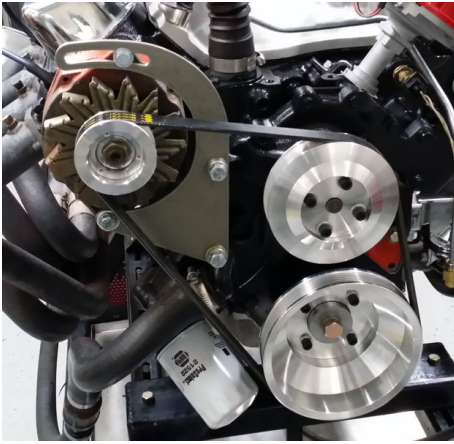

PB71771 SERPENTINE PULLEY AND BRACKET KIT FOR WATER PUMP AND ALTERNATOR

SKU: PB71771

This kit includes billet aluminum crank, water pump, and alternator pulleys, SS crank and water pump pulley bolts, and our stainless alternator bracket kit.

This kit does not include an alternator.

[Read More](#)

Price: \$485.00

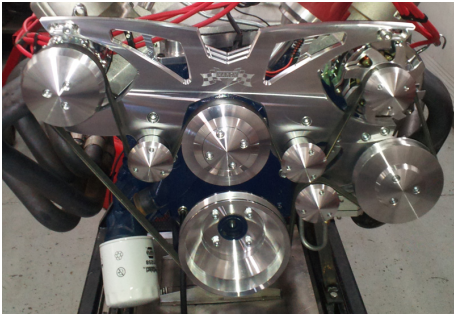

PB71705 SERPENTINE KIT - WATER PUMP, AC, ALTERNATOR (140 AMP) & POWER STEERING W/ FLOWKOOLER WATER PUMP

SKU: PB71705

Serpentine kit for water pump, AC, 140 Amp alternator, and power steering

[Read More](#)

Price: \$2,560.00

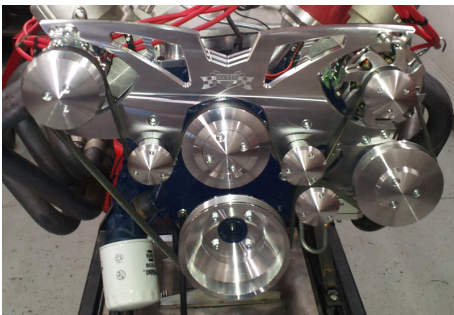

PB71704 SERPENTINE KIT - WATER PUMP, AC, ALTERNATOR (140 AMP) AND POWER STEERING

SKU: PB71704

Serpentine kit for water pump, AC, 140 Amp alternator, and power steering

[Read More](#)

Price: \$2,460.00

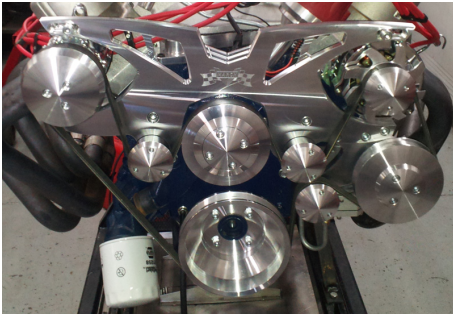

PB71702 SERPENTINE KIT - WATER PUMP, AC, ALTERNATOR (105 AMP) & POWER STEERING

SKU: PB71702

Serpentine kit for water pump, AC, 105 Amp alternator, and power steering

[Read More](#)

Price: \$1,975.00



PB71701 SERPENTINE KIT - WATER PUMP, AC, & ALTERNATOR (105 AMP)

SKU: PB71701

Serpentine kit for water pump, AC, and 105 Amp alternator

[Read More](#)

Price: \$1,675.00



PB64500 BILLET ALUMINUM ALTERNATOR BRACKET KIT

SKU: PB64500

[Read More](#)

Price: \$275.00



PB64421 STAINLESS ALTERNATOR BRACKET KIT

SKU: PB64421

[Read More](#)

Price: \$145.00



PB64120 HIGH MOUNT ALTERNATOR BRACKET KIT

SKU: PB64120

[Read More](#)

Price: \$95.00

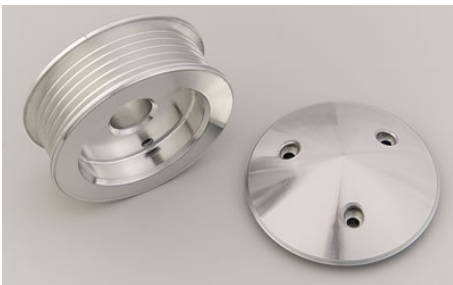

PB62510 BILLET SERPENTINE ALTERNATOR PULLEY

SKU: PB62510

BILLET SERPENTINE ALTERNATOR PULLEY

BILLET ALUMINUM 6-RIB SERPENTINE ALTERNATOR PULLEY WITH NOSE COVER.

Fits '62-'85 390, 429, 472, 500, 425, and 368 engines with factory alternator, or anything with a 10SI / 12SI alternator.

[Read More](#)

Price: \$110.00

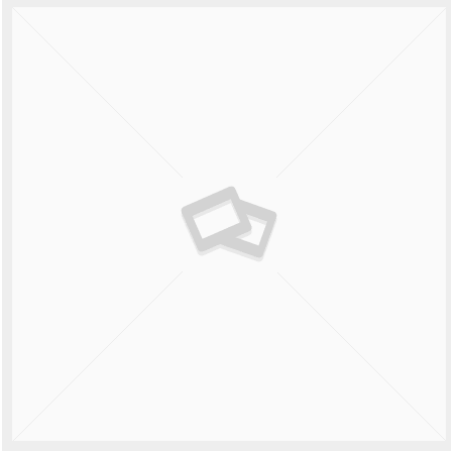

PB62311 CHROME SERPENTINE ALTERNATOR PULLEY

SKU: PB62311

Chrome serpentine alternator pulley without fan. Fits most '62-'79 alternators and works with most stock fans.

[Read More](#)

Price: \$30.00



PB62130 DUAL BELT ALTERNATOR PULLEY

SKU: PB62130

(steel)

[Read More](#)

Price: \$17.00



PB61523 ALTERNATOR PULLEY AND FAN

SKU: PB61523

Billet Aluminum

[Read More](#)

Price: \$130.00



PB61522 ALTERNATOR PULLEY AND FAN

SKU: PB61522

Billet Aluminum (curved blade style)

[Read More](#)

Price: \$95.00



PB60313 CHROME ONE WIRE ALTERNATOR W/SERPENTINE PULLEY

SKU: PB60313

[Read More](#)

Price: \$220.00

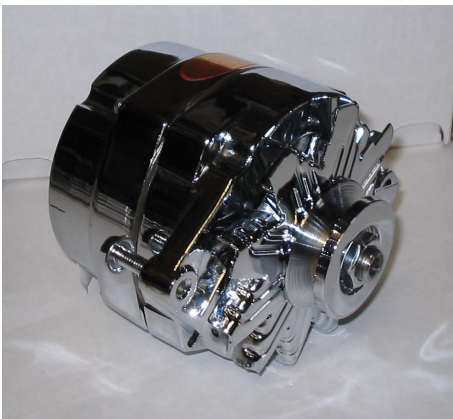

PB60312 CHROME ALTERNATOR

SKU: PB60312

[Read More](#)

Price: \$260.00



PB54311 POWER STEERING PUMP, CHROME, WITH KEYED SHAFT

SKU: PB54311

New Replacement Power Steering Pump, Chrome, with Keyed Shaft for Keyway and Nut Style Pulleys.

Fits all stock '68-'85 472 / 500 / 425 / 368 brackets, and most '63-'67 390 / 429 brackets originally equipped with a standard Saginaw Type 1 style pump. Fits all stock 73-older pulleys and aftermarket keyway type pulleys. Includes reservoir (installed). Finish is black paint on the pump body, with a chrome reservoir. Pulley and bracket not included.

[Read More](#)

Price: \$230.00



PB54211 POWER STEERING PUMP, BLACK, WITH KEYED SHAFT

SKU: PB54211

New Replacement Power Steering Pump with Keyed Shaft for Keyway and Nut Style Pulleys.

Fits all stock '68-'85 472 / 500 / 425 / 368 brackets, and most '63-'67 390 / 429 brackets originally equipped with a standard Saginaw Type 1 style pump. Fits all stock 73-older pulleys and aftermarket keyway type pulleys. Includes reservoir (installed). Finish is black paint. Pulley and bracket not included.

[Read More](#)

Price: \$195.00



PB53652 BILLET SERPENTINE PRESS FIT POWER STEERING PULLEY

SKU: PB53652

Power Steering Pulley Billet Aluminum, smoothie Serpentine, press fit. Made in USA

[Read More](#)

Price: \$185.00



PB53621 STEEL SERPENTINE PRESS FIT POWER STEERING PULLEY

SKU: PB53621

Power Steering Pulley Steel Serpentine, press fit. Made in USA

[Read More](#)

Price: \$80.00

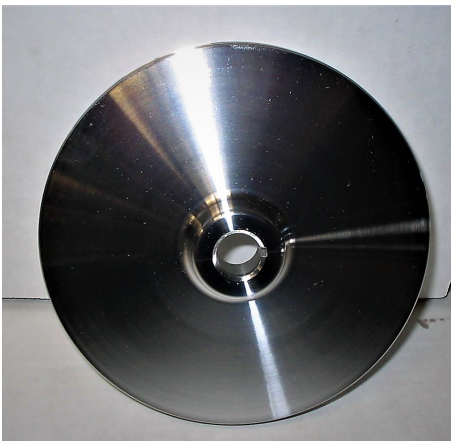

PB52651 BILLET SERPENTINE KEYWAY POWER STEERING PULLEY

SKU: PB52651

Power Steering Pulley Billet Aluminum, smoothie Serpentine, Keyway shaft with nut. Made in USA

[Read More](#)

Price: \$185.00

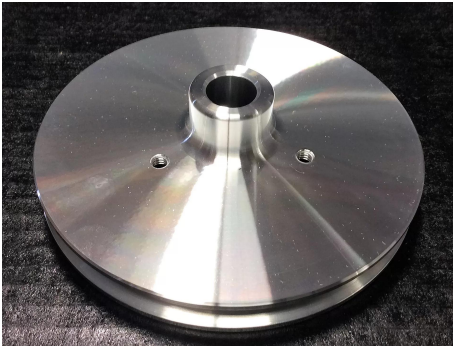

PB51153 BILLET 1 GROOVE PRESS FIT POWER STEERING PULLEY

SKU: PB51153

Billet Aluminum, smoothie
Single groove, Press Fit. Made in USA

[Read More](#)

Price: \$130.00



PB51122 STEEL 1 GROOVE PRESS FIT POWER STEERING PULLEY

SKU: PB51122

PB 1515 Power Steering Pulley Black Steel

Single groove, Press fit style.

Factory replacement for most '74-'85 472 / 500 / 425 / 368 engines.

[Read More](#)

Price: \$40.00

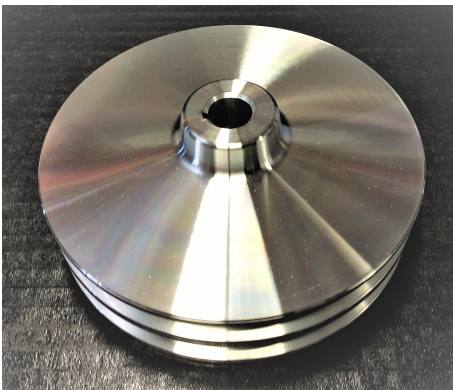

PB50254 BILLET 2 GROOVE KEYWAY POWER STEERING PULLEY

SKU: PB50254

Billet Aluminum, smoothie
Dual groove, Keyway Style. Made in USA

[Read More](#)

Price: \$130.00



PB50223 STEEL 2 GROOVE KEYWAY POWER STEERING PULLEY

SKU: PB50223

Dual groove, keyway shaft/ nut or Press fit style.

[Read More](#)

Price: \$35.00



PB50152 BILLET 1 GROOVE KEYWAY POWER STEERING PULLEY

SKU: PB50152

Billet Aluminum, 5 holes
Single groove, keyway shaft/ nut style.

[Read More](#)

Price: \$85.00



PB50151 BILLET 1 GROOVE KEYWAY POWER STEERING PULLEY

SKU: PB50151

Billet Aluminum, smoothie
Single groove, Keyway shaft with nut. Made in USA

[Read More](#)

Price: \$130.00



PB50121 STEEL 1 GROOVE KEYWAY POWER STEERING PULLEY

SKU: PB50121

PB 1515 Power Steering Pulley Black Steel
Single groove, keyway shaft/ nut or Press fit style.

[Read More](#)

Price: \$40.00



PB34000 R4 BRACKET KIT BILLET ALUMINUM

SKU: PB34000

Billet Aluminum

[Read More](#)

Price: \$324.00

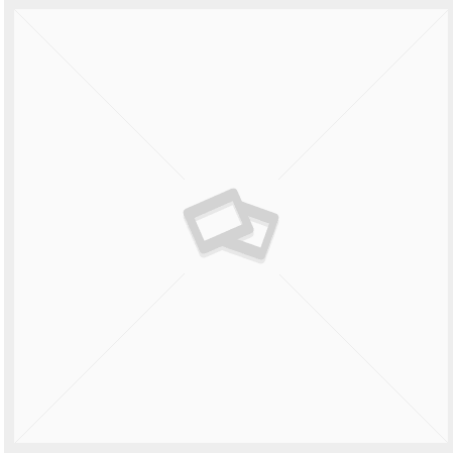

PB32102 R4 CLUTCH COVER ALTERNATE RETAINER FITTING

SKU: PB32102

For use with PB32101 clutch cover IF the included retainer fitting can't be used.

[Read More](#)

Price: \$20.00



PB30411 R4 AC COMPRESSOR NEW (NOT REBUILT), SINGLE V-BELT

SKU: PB30411

Fits '80-'85 368 CID engines with OE AC brackets and '68-'79 472 / 500 / 425 CID engines with Billet PB34000 aftermarket brackets. Single V-belt groove for use with OE '74-'85 pulleys or Billet PB18021 / PB18022 aftermarket pulleys

[Read More](#)

Price: \$440.00



PB18763 CRANK AND WATER PUMP PULLEYS, MULTI-SERPENTINE

SKU: PB18763

Crank and Water Pump Serpentine Crank and Water Pump Pulleys
Made in USA

Billet Aluminum Pulley Set - Triple 6-rib serpentine crank and single serpentine water pump pulley, lines up with stock alternator, PS, and AC spacing. The 3rd belt location can be used to drive other accessories, such as a 2nd alternator, a smog pump, an air compressor, or a ProCharger.

[Read More](#)

Price: \$625.00

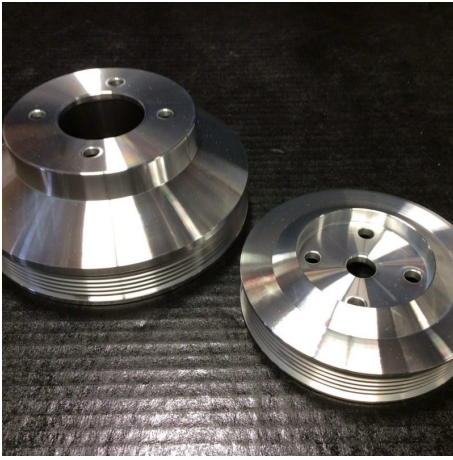

PB18760 CRANK AND WATER PUMP PULLEYS, SINGLE SERPENTINE

SKU: PB18760

Billet Aluminum Pulley Set - Single 6-rib serpentine crank and water pump pulley, lines up with stock alternator spacing.

[Read More](#)

Price: \$600.00



PB18032 BILLET ALUMINUM CRANK AND WATER PUMP PULLEY SET, 2-GROOVE PS / AC, WITH SMOG ('68/'69 AND '71-'73 STYLE)

SKU: PB18032

3 groove crank, 2 groove WP

[Read More](#)

Price: \$600.00



PB18031 BILLET ALUMINUM CRANK AND WATER PUMP PULLEY SET, 2-GROOVE PS / AC, NON-SMOG (1970 STYLE)

SKU: PB18031

3 groove crank, 1 groove WP

[Read More](#)

Price: \$600.00





PB18023 BILLET ALUMINUM CRANK AND WATER PUMP PULLEYS, SINGLE GROOVE PS / AC NON-SMOG, WITH OVERDRIVE WP

SKU: PB18023

2 groove crank, 1 groove OD WP

[Read More](#)

Price: \$600.00



PB18022 BILLET ALUMINUM CRANK AND WATER PUMP PULLEYS, SINGLE GROOVE PS / AC, WITH OR WITHOUT SMOG

SKU: PB18022

2 groove crank, 2 groove WP

[Read More](#)

Price: \$600.00



PB18021 BILLET ALUMINUM CRANK AND WATER PUMP PULLEY SET, NON-SMOG (1974-UP STYLE)

SKU: PB18021

2 groove crank, 1 groove WP

[Read More](#)

Price: \$599.00



PB16102 BILLET ALUMINUM OVERDRIVE WATER PUMP PULLEY

SKU: PB16102

1 groove OD WP pulley

[Read More](#)

Price: \$160.00



PB13001 BILLET ALUMINUM TIMING POINTER

SKU: PB13001

[Read More](#)

Price: \$65.00



PB12306 HARMONIC DAMPER W/ HUB, SFI CERTIFIED

SKU: PB12306

SFI Certified One-Piece Harmonic Vibration Damper

[Read More](#)

Price: \$390.00

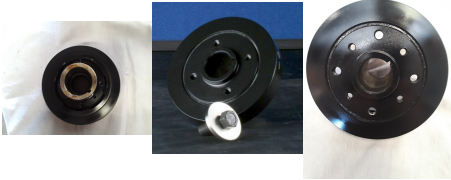

PB11122 CRANK HUB BOLT AND WASHER KIT

SKU: PB11122

Crank Hub Bolt and Washer Kit Correct washer to clear the pulley. Fits the front of the crankshaft, to positively retain the crank hub or damper (or dampener or balancer, as some folks call them).

[Read More](#)

Price: \$15.00

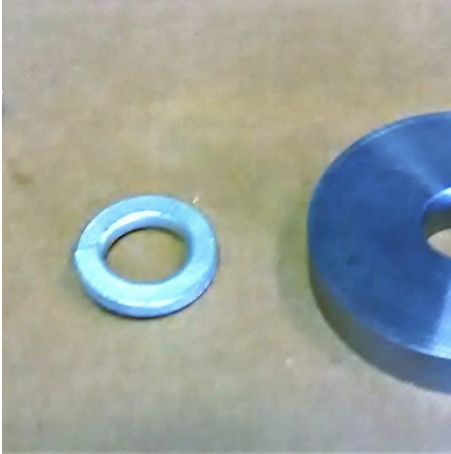

PB11113 CRANK HUB SLEEVE

SKU: PB11113

Crank hub sealing surface repair sleeve.

[Read More](#)

Price: \$95.00

AC COMPONENTS

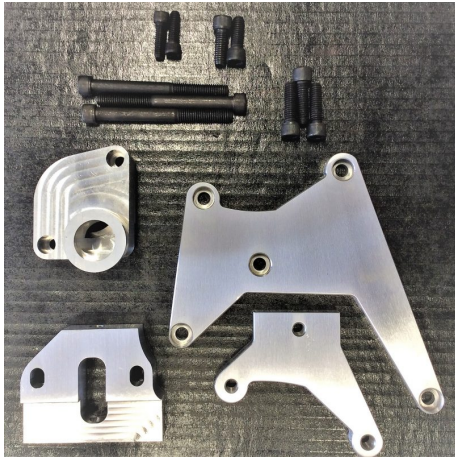

PB34000 R4 BRACKET KIT BILLET ALUMINUM

SKU: PB34000

Billet Aluminum

[Read More](#)

Price: \$324.00

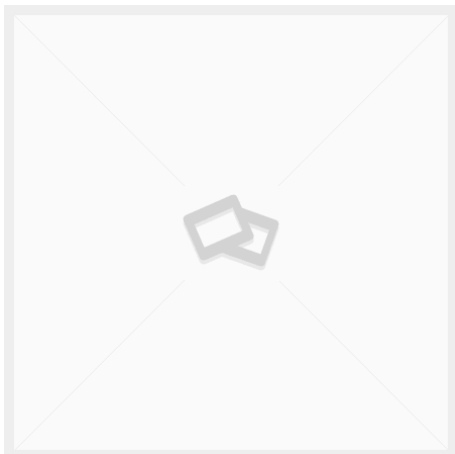

PB32102 R4 CLUTCH COVER ALTERNATE RETAINER FITTING

SKU: PB32102

For use with PB32101 clutch cover IF the included retainer fitting can't be used.

[Read More](#)

Price: \$20.00



PB30411 R4 AC COMPRESSOR NEW (NOT REBUILT), SINGLE V-BELT

SKU: PB30411

Fits '80-'85 368 CID engines with OE AC brackets and '68-'79 472 / 500 / 425 CID engines with Billet PB34000 aftermarket brackets. Single V-belt groove for use with OE '74-'85 pulleys or Billet PB18021 / PB18022 aftermarket pulleys

[Read More](#)

Price: \$440.00

ALTERNATOR

Alternators and related parts.



WS66103 ALTERNATOR WIRING CONVERSION KIT

SKU: WS66103

Alternator Wiring Conversion Kit

Plug-and-play kit for wiring a 3-wire (stock '73-up GM) internally regulated alternator, into vehicles original equipped with an externally regulated GM alternator (such as '62-'72 Cadillacs). Includes adapter plug for alternator and external-regulator-elimination-plug for the connector that used to plug into the external regulator.

[Read More](#)

Price: \$45.00

PB82821 6-RIB SERPENTINE ALTERNATOR BELT - SHORTER BELT FOR 'C'-TYPE BRACKET

SKU: PB82821

6-RIB SERPENTINE ALTERNATOR BELT

ALTERNATOR AND WATER PUMP BELT FOR CADCO SERPENTINE SYSTEM

This belt drives the alternator and water pump, and fits the [PB18763](#) (3-belt) serpentine pulley kit and the ProCharger kit, with mild steel or stainless steel 'C' type brackets.

[Read More](#)

Price: \$45.00

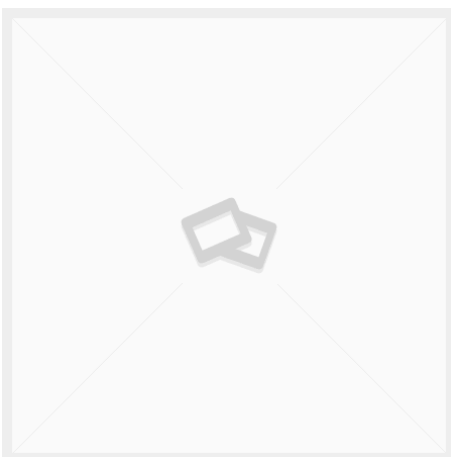

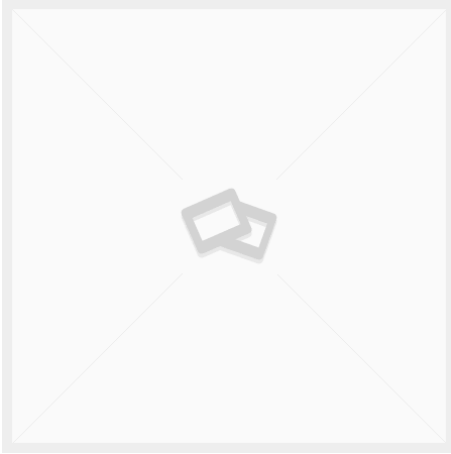

PB82820 6-RIB SERPENTINE ALTERNATOR BELT - STANDARD LENGTH

SKU: PB82820

6-RIB SERPENTINE ALTERNATOR BELT

ALTERNATOR AND WATER PUMP BELT FOR CADCO SERPENTINE SYSTEM

This belt drives the alternator and water pump, and fits the [PB18763](#) (3-belt) serpentine pulley kit and the ProCharger kit, with stock or billet aluminum alternator brackets.

[Read More](#)

Price: \$45.00

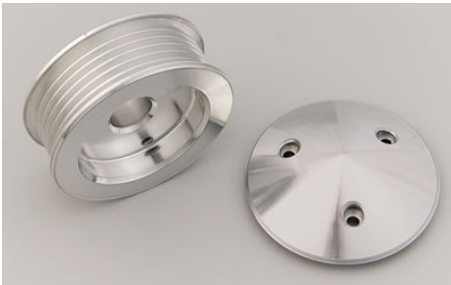

PB62510 BILLET SERPENTINE ALTERNATOR PULLEY

SKU: PB62510

BILLET SERPENTINE ALTERNATOR PULLEY

BILLET ALUMINUM 6-RIB SERPENTINE ALTERNATOR PULLEY WITH NOSE COVER.

Fits '62-'85 390, 429, 472, 500, 425, and 368 engines with factory alternator, or anything with a 10SI / 12SI alternator.

[Read More](#)

Price: \$110.00

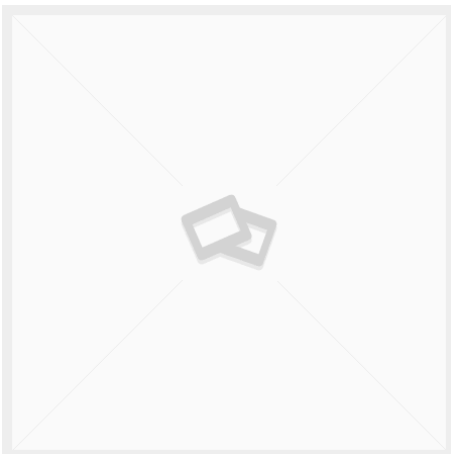

PB62311 CHROME SERPENTINE ALTERNATOR PULLEY

SKU: PB62311

Chrome serpentine alternator pulley without fan. Fits most '62-'79 alternators and works with most stock fans.

[Read More](#)

Price: \$30.00



PB60313 CHROME ONE WIRE ALTERNATOR W/SERPENTINE PULLEY

SKU: PB60313

[Read More](#)

Price: \$220.00

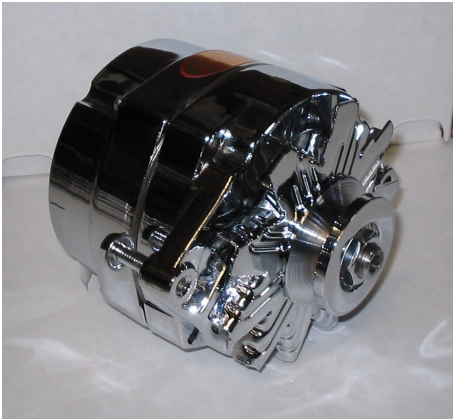

PB60312 CHROME ALTERNATOR

SKU: PB60312

[Read More](#)

Price: \$260.00

BELTS



PB82820 6-RIB SERPENTINE ALTERNATOR BELT - STANDARD LENGTH

SKU: PB82820

6-RIB SERPENTINE ALTERNATOR BELT

ALTERNATOR AND WATER PUMP BELT FOR CADCO SERPENTINE SYSTEM

This belt drives the alternator and water pump, and fits the [PB18763](#) (3-belt) serpentine pulley kit and the ProCharger kit, with stock or billet aluminum alternator brackets.

[Read More](#)

Price: \$45.00

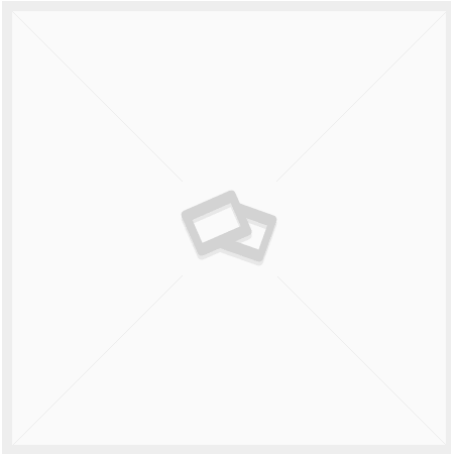

BRACKETS



PB64500 BILLET ALUMINUM ALTERNATOR BRACKET KIT

SKU: PB64500
[Read More](#)

Price: \$275.00



PB64421 STAINLESS ALTERNATOR BRACKET KIT

SKU: PB64421
[Read More](#)

Price: \$145.00



PB64120 HIGH MOUNT ALTERNATOR BRACKET KIT

SKU: PB64120

[Read More](#)

Price: \$95.00



PB34000 R4 BRACKET KIT BILLET ALUMINUM

SKU: PB34000

Billet Aluminum

[Read More](#)

Price: \$324.00

CRANK AND WATER PUMP PULLEYS



PB18763 CRANK AND WATER PUMP PULLEYS, MULTI-SERPENTINE

SKU: PB18763

Crank and Water Pump Serpentine Crank and Water Pump Pulleys

Made in USA

Billet Aluminum Pulley Set - Triple 6-rib serpentine crank and single serpentine water pump pulley, lines up with stock alternator, PS, and AC spacing. The 3rd belt location can be used to drive other accessories, such as a 2nd alternator, a smog pump, an air compressor, or a ProCharger.

[Read More](#)

Price: \$625.00



PB18760 CRANK AND WATER PUMP PULLEYS, SINGLE SERPENTINE

SKU: PB18760

Billet Aluminum Pulley Set - Single 6-rib serpentine crank and water pump pulley, lines up with stock alternator spacing.

[Read More](#)

Price: \$600.00

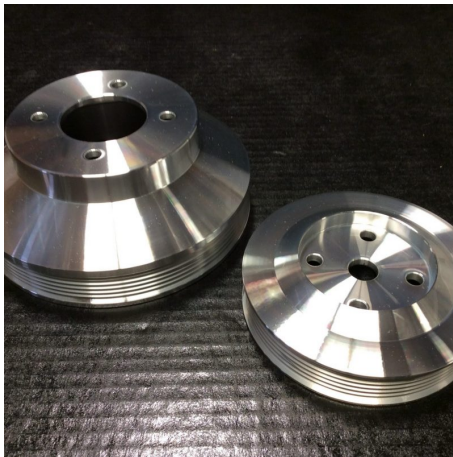



PB18032 BILLET ALUMINUM CRANK AND WATER PUMP PULLEY SET, 2-GROOVE PS / AC, WITH SMOG ('68/'69 AND '71-'73 STYLE)

SKU: PB18032

3 groove crank, 2 groove WP

[Read More](#)

Price: \$600.00



PB18031 BILLET ALUMINUM CRANK AND WATER PUMP PULLEY SET, 2-GROOVE PS / AC, NON-SMOG (1970 STYLE)

SKU: PB18031

3 groove crank, 1 groove WP

[Read More](#)

Price: \$600.00



PB18023 BILLET ALUMINUM CRANK AND WATER PUMP PULLEYS, SINGLE GROOVE PS / AC NON-SMOG, WITH OVERDRIVE WP

SKU: PB18023

2 groove crank, 1 groove OD WP

[Read More](#)

Price: \$600.00



PB18022 BILLET ALUMINUM CRANK AND WATER PUMP PULLEYS, SINGLE GROOVE PS / AC, WITH OR WITHOUT SMOG

SKU: PB18022

2 groove crank, 2 groove WP

[Read More](#)

Price: \$600.00



PB18021 BILLET ALUMINUM CRANK AND WATER PUMP PULLEY SET, NON-SMOG (1974-UP STYLE)

SKU: PB18021

2 groove crank, 1 groove WP

[Read More](#)

Price: \$599.00



PB16102 BILLET ALUMINUM OVERDRIVE WATER PUMP PULLEY

SKU: PB16102

1 groove OD WP pulley

[Read More](#)

Price: \$160.00



PB13001 BILLET ALUMINUM TIMING POINTER

SKU: PB13001

[Read More](#)

Price: \$65.00



PB11122 CRANK HUB BOLT AND WASHER KIT

SKU: PB11122

Crank Hub Bolt and Washer Kit Correct washer to clear the pulley. Fits the front of the crankshaft, to positively retain the crank hub or damper (or dampener or balancer, as some folks call them).

[Read More](#)

Price: \$15.00



PB11113 CRANK HUB SLEEVE

SKU: PB11113

Crank hub sealing surface repair sleeve.

[Read More](#)

Price: \$95.00

POWER STEERING

Power steering pumps, pulleys, brackets, belts, and other related parts.



PB54311 POWER STEERING PUMP, CHROME, WITH KEYED SHAFT

SKU: PB54311

New Replacement Power Steering Pump, Chrome, with Keyed Shaft for Keyway and Nut Style Pulleys.

Fits all stock '68-'85 472 / 500 / 425 / 368 brackets, and most '63-'67 390 / 429 brackets originally equipped with a standard Saginaw Type 1 style pump. Fits all stock 73-older pulleys and aftermarket keyway type pulleys. Includes reservoir (installed). Finish is black paint on the pump body, with a chrome reservoir. Pulley and bracket not included.

[Read More](#)

Price: \$230.00

PB54211 POWER STEERING PUMP, BLACK, WITH KEYED SHAFT

SKU: PB54211

New Replacement Power Steering Pump with Keyed Shaft for Keyway and Nut Style Pulleys.

Fits all stock '68-'85 472 / 500 / 425 / 368 brackets, and most '63-'67 390 / 429 brackets originally equipped with a standard Saginaw Type 1 style pump. Fits all stock 73-older pulleys and aftermarket keyway type pulleys. Includes reservoir (installed). Finish is black paint. Pulley and bracket not included.

[Read More](#)

Price: \$195.00





PB53652 BILLET SERPENTINE PRESS FIT POWER STEERING PULLEY

SKU: PB53652

Power Steering Pulley Billet Aluminum, smoothie Serpentine, press fit. Made in USA

[Read More](#)

Price: \$185.00

PB53621 STEEL SERPENTINE PRESS FIT POWER STEERING PULLEY

SKU: PB53621

Power Steering Pulley Steel Serpentine, press fit. Made in USA

[Read More](#)

Price: \$80.00





PB52651 BILLET SERPENTINE KEYWAY POWER STEERING PULLEY

SKU: PB52651

Power Steering Pulley Billet Aluminum, smoothie Serpentine, Keyway shaft with nut. Made in USA

[Read More](#)

Price: \$185.00

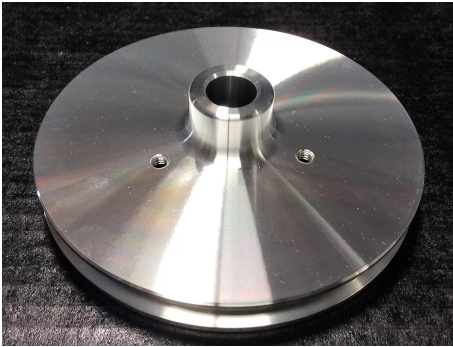

PB51153 BILLET 1 GROOVE PRESS FIT POWER STEERING PULLEY

SKU: PB51153

Billet Aluminum, smoothie Single groove, Press Fit. Made in USA

[Read More](#)

Price: \$130.00



PB51122 STEEL 1 GROOVE PRESS FIT POWER STEERING PULLEY

SKU: PB51122

PB 1515 Power Steering Pulley Black Steel

Single groove, Press fit style.

Factory replacement for most '74-'85 472 / 500 / 425 / 368 engines.

[Read More](#)

Price: \$40.00

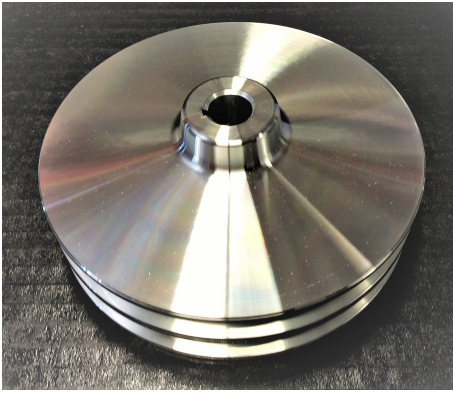

PB50254 BILLET 2 GROOVE KEYWAY POWER STEERING PULLEY

SKU: PB50254

Billet Aluminum, smoothie
Dual groove, Keyway Style. Made in USA

[Read More](#)

Price: \$130.00



PB50223 STEEL 2 GROOVE KEYWAY POWER STEERING PULLEY

SKU: PB50223

Dual groove, keyway shaft/ nut or Press fit style.

[Read More](#)

Price: \$35.00





PB50152 BILLET 1 GROOVE KEYWAY POWER STEERING PULLEY

SKU: PB50152

Billet Aluminum, 5 holes
Single groove, keyway shaft/ nut style.

[Read More](#)

Price: \$85.00

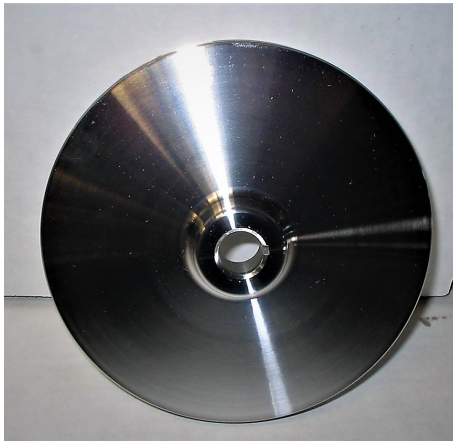

PB50151 BILLET 1 GROOVE KEYWAY POWER STEERING PULLEY

SKU: PB50151

Billet Aluminum, smoothie
Single groove, Keyway shaft with nut. Made in USA

[Read More](#)

Price: \$130.00



PB50121 STEEL 1 GROOVE KEYWAY POWER STEERING PULLEY

SKU: PB50121

PB 1515 Power Steering Pulley Black Steel
Single groove, keyway shaft/ nut or Press fit style.

[Read More](#)

Price: \$40.00

PULLEYS AND RELATED PARTS

Pulleys - serpentine pulleys, v-belt pulleys, timing pointers, etc.

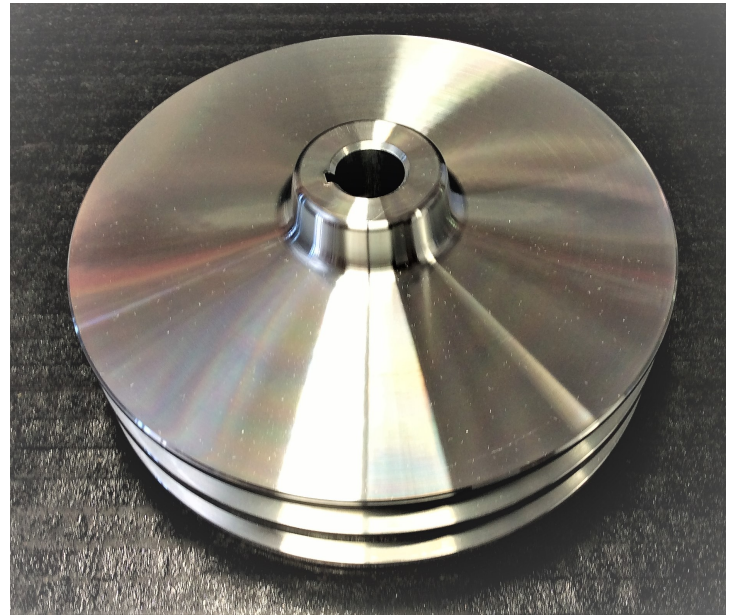

PB62311 CHROME SERPENTINE ALTERNATOR PULLEY

SKU: PB62311

Chrome serpentine alternator pulley without fan. Fits most '62-'79 alternators and works with most stock fans.

[Read More](#)

Price: \$30.00

PB62130 DUAL BELT ALTERNATOR PULLEY

SKU: PB62130

(steel)

[Read More](#)

Price: \$17.00





PB61523 ALTERNATOR PULLEY AND FAN

SKU: PB61523

Billet Aluminum

[Read More](#)

Price: \$130.00



PB61522 ALTERNATOR PULLEY AND FAN

SKU: PB61522

Billet Aluminum (curved blade style)

[Read More](#)

Price: \$95.00



PB53652 BILLET SERPENTINE PRESS FIT POWER STEERING PULLEY

SKU: PB53652

Power Steering Pulley Billet Aluminum, smoothie Serpentine, press fit. Made in USA

[Read More](#)

Price: \$185.00

PB53621 STEEL SERPENTINE PRESS FIT POWER STEERING PULLEY

SKU: PB53621

Power Steering Pulley Steel
Serpentine, press fit. Made in USA

[Read More](#)

Price: \$80.00



PB52651 BILLET SERPENTINE KEYWAY POWER STEERING PULLEY

SKU: PB52651

Power Steering Pulley Billet Aluminum, smoothie
Serpentine, Keyway shaft with nut. Made in USA

[Read More](#)

Price: \$185.00

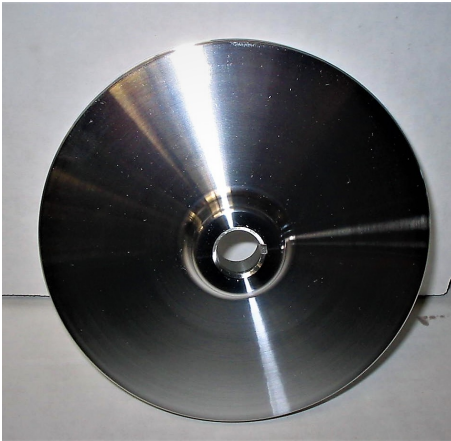

PB51153 BILLET 1 GROOVE PRESS FIT POWER STEERING PULLEY

SKU: PB51153

Billet Aluminum, smoothie
Single groove, Press Fit. Made in USA

[Read More](#)

Price: \$130.00

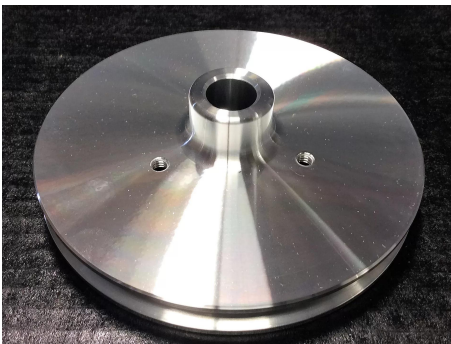



PB51122 STEEL 1 GROOVE PRESS FIT POWER STEERING PULLEY

SKU: PB51122

PB 1515 Power Steering Pulley Black Steel

Single groove, Press fit style.

Factory replacement for most '74-'85 472 / 500 / 425 / 368 engines.

[Read More](#)

Price: \$40.00

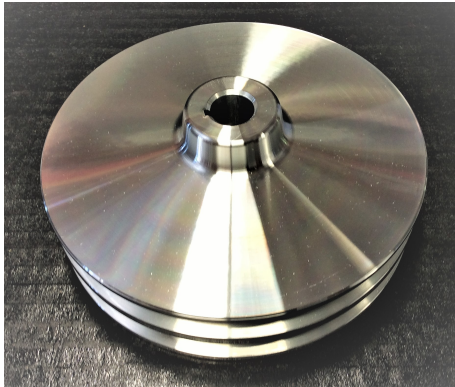

PB50254 BILLET 2 GROOVE KEYWAY POWER STEERING PULLEY

SKU: PB50254

Billet Aluminum, smoothie

Dual groove, Keyway Style. Made in USA

[Read More](#)

Price: \$130.00

PB50223 STEEL 2 GROOVE KEYWAY POWER STEERING PULLEY

SKU: PB50223

Dual groove, keyway shaft/ nut or Press fit style.

[Read More](#)

Price: \$35.00



PB50152 BILLET 1 GROOVE KEYWAY POWER STEERING PULLEY

SKU: PB50152

Billet Aluminum, 5 holes
Single groove, keyway shaft/ nut style.

[Read More](#)

Price: \$85.00





PB50151 BILLET 1 GROOVE KEYWAY POWER STEERING PULLEY

SKU: PB50151

Billet Aluminum, smoothie
Single groove, Keyway shaft with nut. Made in USA

[Read More](#)

Price: \$130.00



PB50121 STEEL 1 GROOVE KEYWAY POWER STEERING PULLEY

SKU: PB50121

PB 1515 Power Steering Pulley Black Steel
Single groove, keyway shaft/ nut or Press fit style.

[Read More](#)

Price: \$40.00

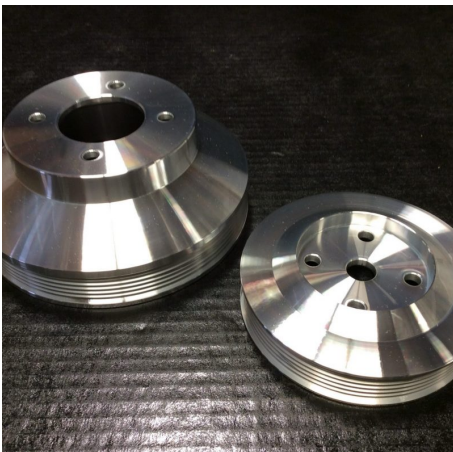

PB18760 CRANK AND WATER PUMP PULLEYS, SINGLE SERPENTINE

SKU: PB18760

Billet Aluminum Pulley Set - Single 6-rib serpentine crank and water pump pulley, lines up with stock alternator spacing.

[Read More](#)

Price: \$600.00



PB18032 BILLET ALUMINUM CRANK AND WATER PUMP PULLEY SET, 2-GROOVE PS / AC, WITH SMOG ('68/'69 AND '71-'73 STYLE)

SKU: PB18032

3 groove crank, 2 groove WP

[Read More](#)

Price: \$600.00



PB18031 BILLET ALUMINUM CRANK AND WATER PUMP PULLEY SET, 2-GROOVE PS / AC, NON-SMOG (1970 STYLE)

SKU: PB18031

3 groove crank, 1 groove WP

[Read More](#)

Price: \$600.00



PB18021 BILLET ALUMINUM CRANK AND WATER PUMP PULLEY SET, NON-SMOG (1974-UP STYLE)

SKU: PB18021

2 groove crank, 1 groove WP

[Read More](#)

Price: \$599.00



PB13001 BILLET ALUMINUM TIMING POINTER

SKU: PB13001

[Read More](#)

Price: \$65.00

SERPENTINE DRIVE KITS AND PARTS



WS66103 ALTERNATOR WIRING CONVERSION KIT

SKU: WS66103

Alternator Wiring Conversion Kit

Plug-and-play kit for wiring a 3-wire (stock '73-up GM) internally regulated alternator, into vehicles original equipped with an externally regulated GM alternator (such as '62-'72 Cadillacs). Includes adapter plug for alternator and external-regulator-elimination-plug for the connector that used to plug into the external regulator.

[Read More](#)

Price: \$45.00

PB82821 6-RIB SERPENTINE ALTERNATOR BELT - SHORTER BELT FOR 'C'-TYPE BRACKET

SKU: PB82821

6-RIB SERPENTINE ALTERNATOR BELT

ALTERNATOR AND WATER PUMP BELT FOR CADCO SERPENTINE SYSTEM

This belt drives the alternator and water pump, and fits the [PB18763](#) (3-belt) serpentine pulley kit and the ProCharger kit, with mild steel or stainless steel 'C' type brackets.

[Read More](#)

Price: \$45.00

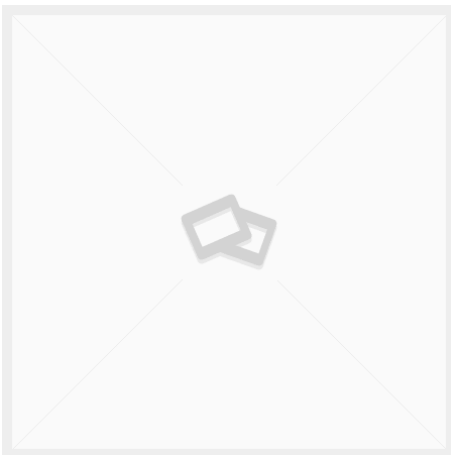

PB82820 6-RIB SERPENTINE ALTERNATOR BELT - STANDARD LENGTH

SKU: PB82820

6-RIB SERPENTINE ALTERNATOR BELT

ALTERNATOR AND WATER PUMP BELT FOR CADCO SERPENTINE SYSTEM

This belt drives the alternator and water pump, and fits the [PB18763](#) (3-belt) serpentine pulley kit and the ProCharger kit, with stock or billet aluminum alternator brackets.

[Read More](#)

Price: \$45.00

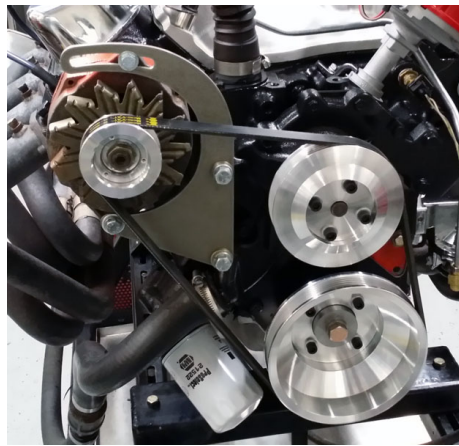

PB71773 SERPENTINE PULLEY AND BILLET BRACKET KIT WITH POLISHED ALUMINUM 140 AMP ALTERNATOR PB71773

SKU: PB71773

This kit includes billet aluminum crank and water pump pulleys, SS crank and water pump pulley bolts, our billet aluminum alternator bracket kit, and a polished aluminum 140-Amp 1-wire alternator with billet aluminum pulley.

Note: Includes polished alternator, rather than the un-chromed version in the picture.

[Read More](#)

Price: \$975.00

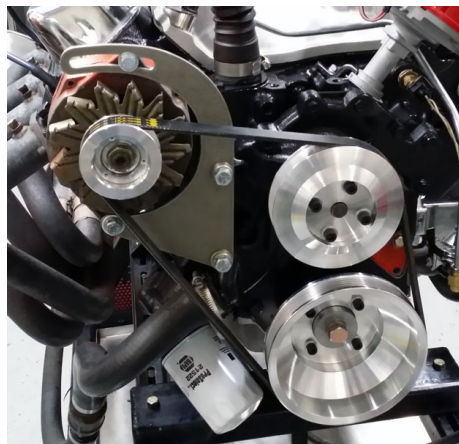

PB71772 SERPENTINE PULLEY AND BRACKET KIT WITH CHROME 105 AMP ALTERNATOR

SKU: PB71772

This kit includes billet aluminum crank and water pump pulleys, SS crank and water pump pulley bolts, our stainless alternator bracket kit, and a chrome 105-Amp 1-wire alternator with chrome pulley.

Note: Includes chrome alternator, rather than the un-chromed version in the picture.

[Read More](#)

Price: \$625.00

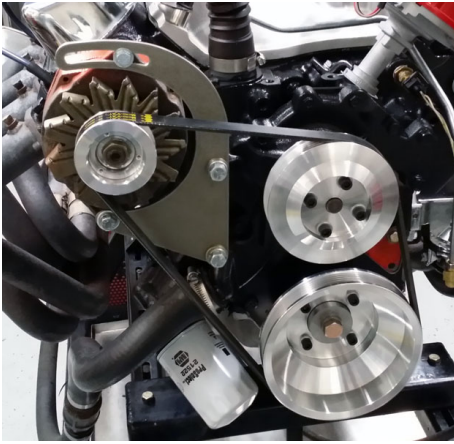

PB71771 SERPENTINE PULLEY AND BRACKET KIT FOR WATER PUMP AND ALTERNATOR

SKU: PB71771

This kit includes billet aluminum crank, water pump, and alternator pulleys, SS crank and water pump pulley bolts, and our stainless alternator bracket kit.

This kit does not include an alternator.

[Read More](#)

Price: \$485.00

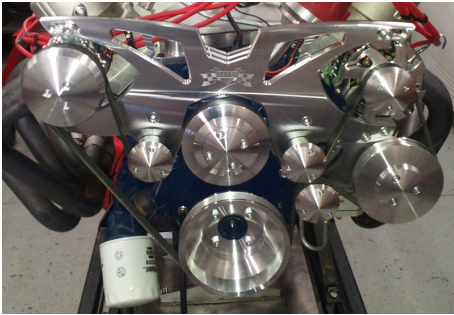

PB71705 SERPENTINE KIT - WATER PUMP, AC, ALTERNATOR (140 AMP) & POWER STEERING W/ FLOWKOOLER WATER PUMP

SKU: PB71705

Serpentine kit for water pump, AC, 140 Amp alternator, and power steering

[Read More](#)

Price: \$2,560.00

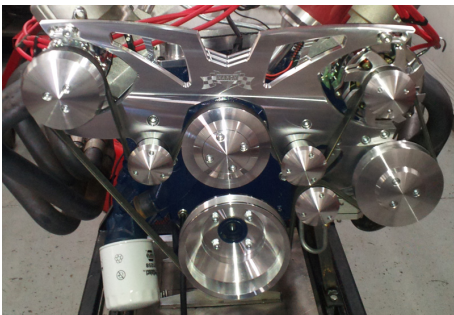

PB71704 SERPENTINE KIT - WATER PUMP, AC, ALTERNATOR (140 AMP) AND POWER STEERING

SKU: PB71704

Serpentine kit for water pump, AC, 140 Amp alternator, and power steering

[Read More](#)

Price: \$2,460.00

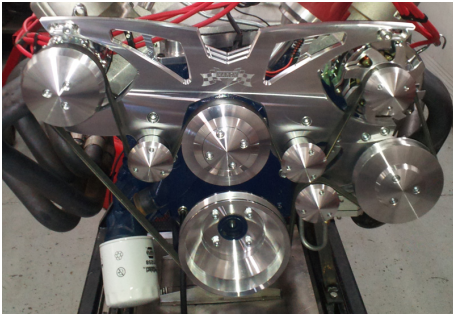

PB71702 SERPENTINE KIT - WATER PUMP, AC, ALTERNATOR (105 AMP) & POWER STEERING

SKU: PB71702

Serpentine kit for water pump, AC, 105 Amp alternator, and power steering

[Read More](#)

Price: \$1,975.00



PB71701 SERPENTINE KIT - WATER PUMP, AC, & ALTERNATOR (105 AMP)

SKU: PB71701

Serpentine kit for water pump, AC, and 105 Amp alternator

[Read More](#)

Price: \$1,675.00



PB64500 BILLET ALUMINUM ALTERNATOR BRACKET KIT

SKU: PB64500

[Read More](#)

Price: \$275.00



PB64421 STAINLESS ALTERNATOR BRACKET KIT

SKU: PB64421

[Read More](#)

Price: \$145.00



PB64120 HIGH MOUNT ALTERNATOR BRACKET KIT

SKU: PB64120

[Read More](#)

Price: \$95.00



PB62510 BILLET SERPENTINE ALTERNATOR PULLEY

SKU: PB62510

BILLET SERPENTINE ALTERNATOR PULLEY

BILLET ALUMINUM 6-RIB SERPENTINE ALTERNATOR PULLEY WITH NOSE COVER.

Fits '62-'85 390, 429, 472, 500, 425, and 368 engines with factory alternator, or anything with a 10SI / 12SI alternator.

[Read More](#)

Price: \$110.00

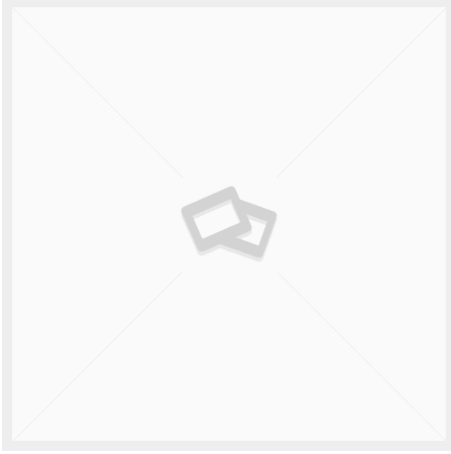

PB62311 CHROME SERPENTINE ALTERNATOR PULLEY

SKU: PB62311

Chrome serpentine alternator pulley without fan. Fits most '62-'79 alternators and works with most stock fans.

[Read More](#)

Price: \$30.00



PB60313 CHROME ONE WIRE ALTERNATOR W/SERPENTINE PULLEY

SKU: PB60313

[Read More](#)

Price: \$220.00

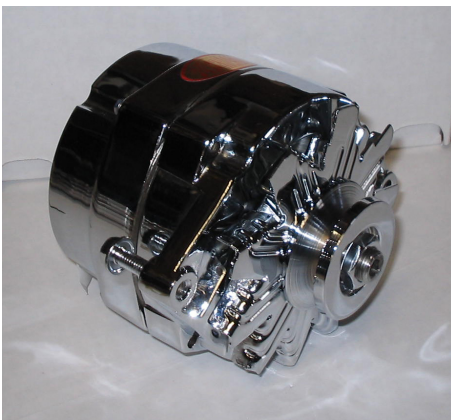

PB60312 CHROME ALTERNATOR

SKU: PB60312

[Read More](#)

Price: \$260.00



PB53652 BILLET SERPENTINE PRESS FIT POWER STEERING PULLEY

SKU: PB53652

Power Steering Pulley Billet Aluminum, smoothie Serpentine, press fit. Made in USA

[Read More](#)

Price: \$185.00



PB53621 STEEL SERPENTINE PRESS FIT POWER STEERING PULLEY

SKU: PB53621

Power Steering Pulley Steel Serpentine, press fit. Made in USA

[Read More](#)

Price: \$80.00



PB52651 BILLET SERPENTINE KEYWAY POWER STEERING PULLEY

SKU: PB52651

Power Steering Pulley Billet Aluminum, smoothie Serpentine, Keyway shaft with nut. Made in USA

[Read More](#)

Price: \$185.00

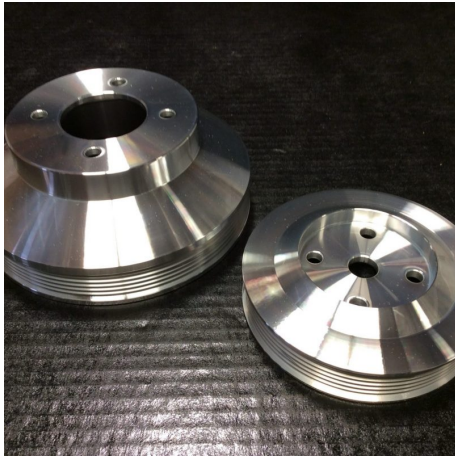

PB18760 CRANK AND WATER PUMP PULLEYS, SINGLE SERPENTINE

SKU: PB18760

Billet Aluminum Pulley Set - Single 6-rib serpentine crank and water pump pulley, lines up with stock alternator spacing.

[Read More](#)

Price: \$600.00

SWAP COMPONENTS, ADAPTERS, AND MOTOR MOUNTS



SM91002 472 / 500 / 425 / 368 INTO X-FRAME 54-65 CADILLAC SWAP PARTS

SKU: SM91002

This list of parts includes common items needed to swap a 472, 500, 425, or 368 into most X-frame '54-'65 RWD Cadillac cars. For perimeter frame cars, see the '63-'67 swap kit.

[Read More](#)

Price: \$30.00 - \$575.00

SM91001 472 / 500 / 425 / 368 INTO 63-67 CADILLAC SWAP PARTS

SKU: SM91001

This list of parts includes common items needed to swap a 472, 500, 425, or 368 into most perimeter frame '65-'67 RWD Cadillac cars. For X-frame cars, see the '59-'65 swap kit.

[Read More](#)

Price: \$17.50 - \$550.00



SM51180 MOTOR MOUNT KIT WELD-IN

SKU: SM51180

Weld-in Motor Mount Kit

[Read More](#)

Price: \$245.00

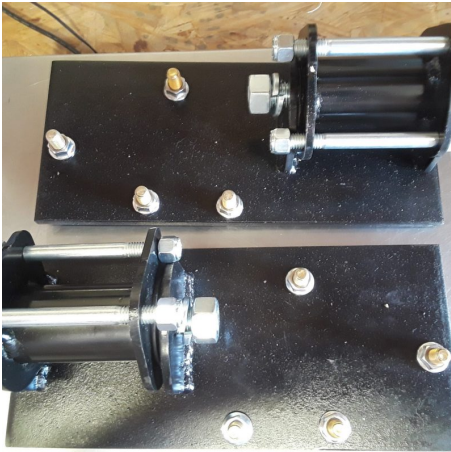

SM51170 G-BODY MOTOR MOUNT KIT

SKU: SM51170

Fits '78-'87 G-Body (Monte Carlo, Malibu, El Camino, Regal, Cutlass, Grand Prix, etc).

Bolts in using existing V8 mount holes, locates engine to clear stock AC, etc.

Uses stock Caddy mechanical fan with stock G-Body V8 radiator and fan shroud.

Does not clear stock column shifters - floor shift or adjustable column shift kit required.

[Read More](#)

Price: \$340.00



SM51160 UNIVERSAL MOTOR MOUNT KIT

SKU: SM51160

Intended for chassis with standard style V8 side mounts, such as 70s Chevy clamshell style.

Includes mounts, adapters, bolts, and instructions.

Can be installed with no welding.

[Read More](#)

Price: \$105.00



SM51150 '60-'64 500 SWAP MOTOR MOUNT KIT

SKU: SM51150

Motor Mount Kit for installing a 472 / 500 / 425 / 368 into a '60-'64 Cadillac

[Read More](#)

Price: \$275.00



SM11115 CADILLAC MOTOR MOUNTS '77-UP RWD

SKU: SM11115

Cadillac Motor Mounts '77-up RWD

[Read More](#)

Price: \$25.00

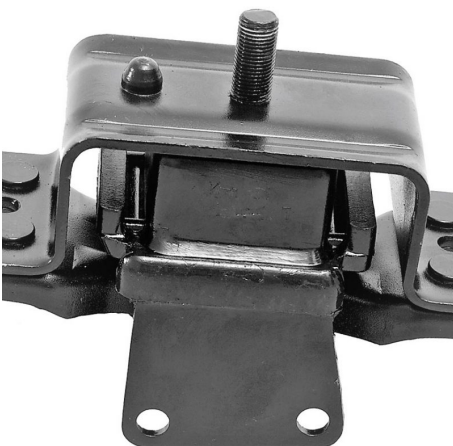

SM11112 HD CADILLAC MOTOR MOUNTS '74-'76

SKU: SM11112

Heavy Duty Cadillac Motor Mounts for '74-'76 (all models exc. Seville)

[Read More](#)

Price: \$30.00

SM11111 HD CADILLAC MOTOR MOUNTS '68-'73 RWD AND '73 ELDO

SKU: SM11111

Heavy duty steel caged style

Fits '68-'74 RWD, '73-'74 and '77-'78 Eldo, with offset stud.

[Read More](#)

Price: \$17.50



OS63012 OIL FILTER ADAPTER LINES EXIT STRAIGHT

SKU: OS63012

[Read More](#)

Price: \$45.00





OS63011 REMOTE OIL FILTER ADAPTER-- SIDE EXIT

SKU: OS63011

[Read More](#)

Price: \$45.00

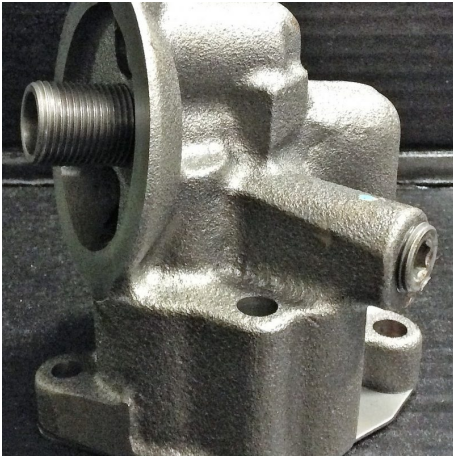

OS31122 GOLD SERIES "SPECIAL CHASSIS" OIL PUMP

SKU: OS31122

Gold Series "Special Chassis" Oil Pump

[Read More](#)

Price: \$329.41



OS23121 REAR SUMP OIL PICKUP TUBE

SKU: OS23121

Rear Sump Oil Pickup Tube OS23121 High Performance, Made in USA

[Read More](#)

Price: \$165.00



OS13122 REAR SUMP ALUMINUM OIL PAN

SKU: OS13122

All non-Eldo 68-up Cadillacs came with either a front sump or mid-sump oil pan.

A true rear sump pan is generally required for most non-Ford swaps, including all of our bolt-in kits.

GMC motorhomes and Eldorados require an original Eldo oil pan - aftermarket pans will not fit.

'65-'67 Cadillacs require a front sump oil pan, as found on '68-'76 non-Eldo Cadillacs.

[Read More](#)

Price: \$552.00



KSM11304 MOTOR MOUNT 61-65

SKU: kSM11304

[Read More](#)

Price: \$25.00



DS31203 CADILLAC 429 TO BOP / CADILLAC TRANSMISSION ADAPTER

SKU: kDS31203

Cadillac 429 Engine to BOP / '68-up Cadillac Transmission Adapter Kit. 5/16 cold rolled steel, CNC cut bolt holes and threads. Includes countersunk bolts (4) and 1 piece flex plate spacers(3).

Fits '64-'67 Cadillac 429 engine with starter mounting bolt holes in the block.

[Read More](#)

Price: \$140.00



DS31201 CADILLAC 429 TO CHEVY TRANSMISSION ADAPTER

SKU: kDS31201

Cadillac 429 Engine to Chevy Transmission Adapter Kit. 5/16 cold rolled steel, CNC cut bolt holes and threads. Includes countersunk bolts (4) and 1 piece flex plate spacers(3).

[Read More](#)

Price: \$140.00



DS31103 CADILLAC 472/500/425/368 TO CADILLAC 429 SPEC TH400 TRANSMISSION ADAPTER

SKU: DS31103

Cadillac 472/500/425/368 Engine to 429 Cadillac Transmission Adapter Kit. 5/16 cold rolled steel, CNC cut bolt holes and threads. Includes 1 piece flexplate spacers(3) Note: Will not work on some early 429s that had the cast iron adapter.

[Read More](#)

Price: \$160.00



DS31101 CADILLAC TO CHEVY TRANSMISSION ADAPTER

SKU: DS31101

Cadillac 472/500/425/368 Engine to Chevy Transmission Adapter Kit. 5/16 cold rolled steel, CNC cut bolt holes and threads. Includes 1 piece flex plate spacers(3).

[Read More](#)

Price: \$140.00

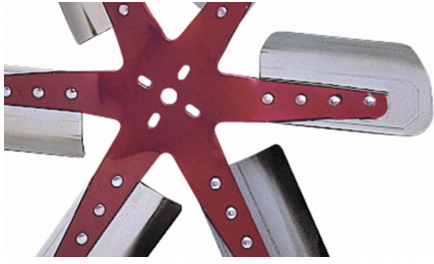

CS81102 LOW PROFILE FLEX FAN KIT, RED

SKU: CS81102

Red Low Profile Flex Fan Kit

[Read More](#)

Price: \$185.00



CS81101 LOW PROFILE FLEX FAN KIT, BLUE

SKU: CS81101

Blue Low Profile Flex Fan Kit

[Read More](#)

Price: \$185.00

SWAP KITS

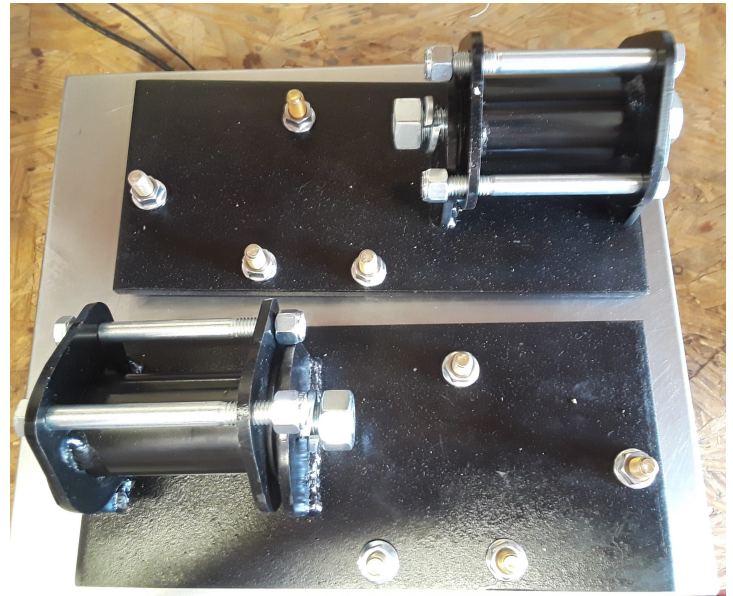

SM91002 472 / 500 / 425 / 368 INTO X-FRAME 54-65 CADILLAC SWAP PARTS

SKU: SM91002

This list of parts includes common items needed to swap a 472, 500, 425, or 368 into most X-frame '54-'65 RWD Cadillac cars. For perimeter frame cars, see the '63-'67 swap kit.

[Read More](#)

Price: \$30.00 - \$575.00

SM91001 472 / 500 / 425 / 368 INTO 63-67 CADILLAC SWAP PARTS

SKU: SM91001

This list of parts includes common items needed to swap a 472, 500, 425, or 368 into most perimeter frame '65-'67 RWD Cadillac cars. For X-frame cars, see the '59-'65 swap kit.

[Read More](#)

Price: \$17.50 - \$550.00

MOTOR MOUNTS AND KITS

Motor Mounts and Swap Motor Mount Kits



SM51180 MOTOR MOUNT KIT WELD-IN

SKU: SM51180

Weld-in Motor Mount Kit

[Read More](#)

Price: \$245.00



SM51170 G-BODY MOTOR MOUNT KIT

SKU: SM51170

Fits '78-'87 G-Body (Monte Carlo, Malibu, El Camino, Regal, Cutlass, Grand Prix, etc).

Bolts in using existing V8 mount holes, locates engine to clear stock AC, etc.

Uses stock Caddy mechanical fan with stock G-Body V8 radiator and fan shroud.

Does not clear stock column shifters - floor shift or adjustable column shift kit required.

[Read More](#)

Price: \$340.00



SM51160 UNIVERSAL MOTOR MOUNT KIT

SKU: SM51160

Intended for chassis with standard style V8 side mounts, such as 70s Chevy clamshell style.
Includes mounts, adapters, bolts, and instructions.
Can be installed with no welding.

[Read More](#)

Price: \$105.00



SM51150 '60-'64 500 SWAP MOTOR MOUNT KIT

SKU: SM51150

Motor Mount Kit for installing a 472 / 500 / 425 / 368 into a '60-'64 Cadillac

[Read More](#)

Price: \$275.00



SM11115 CADILLAC MOTOR MOUNTS '77-UP RWD

SKU: SM11115

Cadillac Motor Mounts '77-up RWD

[Read More](#)

Price: \$25.00

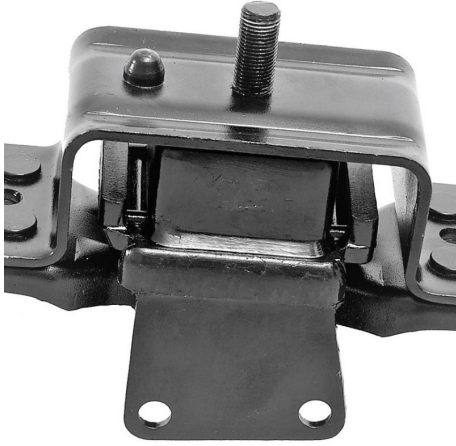

SM11112 HD CADILLAC MOTOR MOUNTS '74-'76

SKU: SM11112

Heavy Duty Cadillac Motor Mounts for '74-'76 (all models exc. Seville)

[Read More](#)

Price: \$30.00



SM11111 HD CADILLAC MOTOR MOUNTS '68-'73 RWD AND '73 ELDO

SKU: SM11111

Heavy duty steel caged style

Fits '68-'74 RWD, '73-'74 and '77-'78 Eldo, with offset stud.

[Read More](#)

Price: \$17.50





KSM11304 MOTOR MOUNT 61-65

SKU: kSM11304

[Read More](#)

Price: \$25.00



DS31203 CADILLAC 429 TO BOP / CADILLAC TRANSMISSION ADAPTER

SKU: kDS31203

Cadillac 429 Engine to BOP / '68-up Cadillac Transmission Adapter Kit. 5/16 cold rolled steel, CNC cut bolt holes and threads. Includes countersunk bolts (4) and 1 piece flex plate spacers(3).

Fits '64-'67 Cadillac 429 engine with starter mounting bolt holes in the block.

[Read More](#)

Price: \$140.00



DS31201 CADILLAC 429 TO CHEVY TRANSMISSION ADAPTER

SKU: kDS31201

Cadillac 429 Engine to Chevy Transmission Adapter Kit. 5/16 cold rolled steel, CNC cut bolt holes and threads. Includes countersunk bolts (4) and 1 piece flex plate spacers(3).

[Read More](#)

Price: \$140.00



DS31101 CADILLAC TO CHEVY TRANSMISSION ADAPTER

SKU: DS31101

Cadillac 472/500/425/368 Engine to Chevy Transmission Adapter Kit. 5/16 cold rolled steel, CNC cut bolt holes and threads. Includes 1 piece flex plate spacers(3).

[Read More](#)

Price: \$140.00

OTHER SWAP COMPONENTS

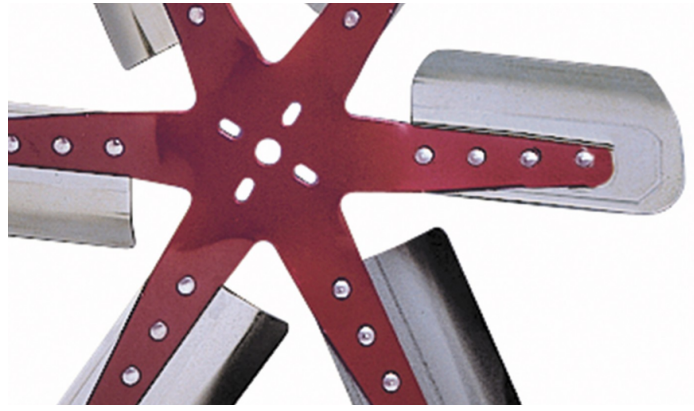

OS63012 OIL FILTER ADAPTER LINES EXIT STRAIGHT

SKU: OS63012

[Read More](#)

Price: \$45.00



OS63011 REMOTE OIL FILTER ADAPTER--SIDE EXIT

SKU: OS63011

[Read More](#)

Price: \$45.00

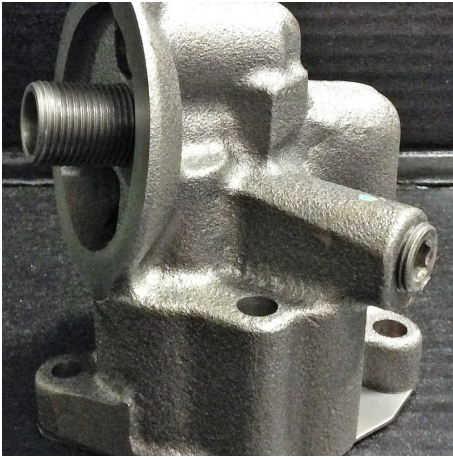

OS31122 GOLD SERIES "SPECIAL CHASSIS" OIL PUMP

SKU: OS31122

Gold Series "Special Chassis" Oil Pump

[Read More](#)

Price: \$329.41



OS23121 REAR SUMP OIL PICKUP TUBE

SKU: OS23121

Rear Sump Oil Pickup Tube OS23121 High Performance, Made in USA

[Read More](#)

Price: \$165.00



OS13122 REAR SUMP ALUMINUM OIL PAN

SKU: OS13122

All non-Eldo 68-up Cadillacs came with either a front sump or mid-sump oil pan.

A true rear sump pan is generally required for most non-Ford swaps, including all of our bolt-in kits.

GMC motorhomes and Eldorados require an original Eldo oil pan - aftermarket pans will not fit.

'65-'67 Cadillacs require a front sump oil pan, as found on '68-'76 non-Eldo Cadillacs.

[Read More](#)

Price: \$552.00





DS31103 CADILLAC 472/500/425/368 TO CADILLAC 429 SPEC TH400 TRANSMISSION ADAPTER

SKU: DS31103

Cadillac 472/500/425/368 Engine to 429 Cadillac Transmission Adapter Kit. 5/16 cold rolled steel, CNC cut bolt holes and threads. Includes 1 piece flexplate spacers(3) Note: Will not work on some early 429s that had the cast iron adapter.

[Read More](#)

Price: \$160.00

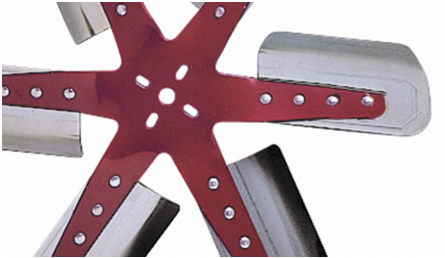

CS81102 LOW PROFILE FLEX FAN KIT, RED

SKU: CS81102

Red Low Profile Flex Fan Kit

[Read More](#)

Price: \$185.00



CS81101 LOW PROFILE FLEX FAN KIT, BLUE

SKU: CS81101

Blue Low Profile Flex Fan Kit

[Read More](#)

Price: \$185.00

TOOLS AND SUPPLIES

Special tools and supplies for getting your project done.

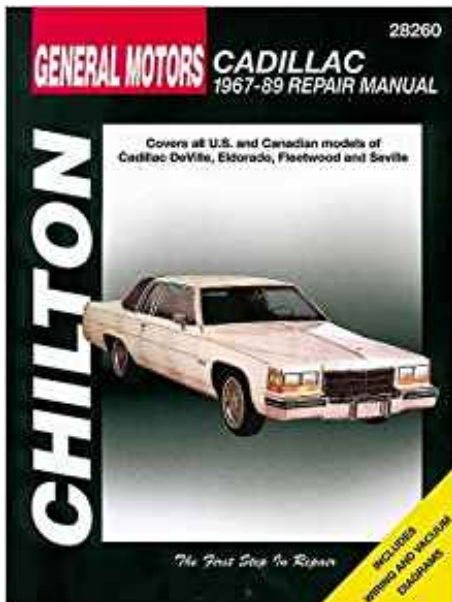

TS91011 CHILTON MANUAL '67-'89 CAD.

SKU: TS91011

'67-'89 Cad. Big book w/ wiring & vacuum diagrams

[Read More](#)

Price: \$45.00

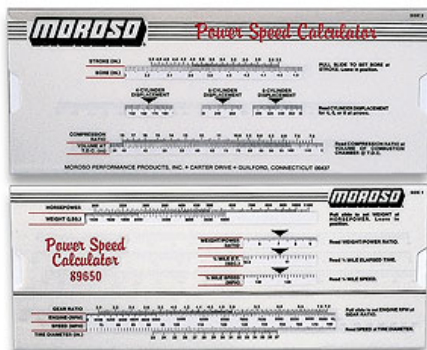

TS91001 MOROSO POWER/SPEED SLIDE RULE CALCULATOR

SKU: TS91001

For calculating power/ weight/ ET/ MPH (1/4 mile) and gear/ tire/ RPM/ MPH.

[Read More](#)

Price: \$16.00



TS71004 VALVE SPRING COMPRESSOR

SKU: TS71004

Top-side style

[Read More](#)

Price: \$70.00



TS71002 SPARK PLUG HOLE AIR HOSE

SKU: TS71002

Screws into spark plug hole.
Hooks to compressed air line to hold valves in place while changing springs on an assembled engine.

[Read More](#)

Price: \$15.00



TS71001 TDC PISTON STOP

SKU: TS71001

Screws into spark plug hole

[Read More](#)

Price: \$30.00



TS31101 OIL PRIMER TOOL FOR '66 AND UP CADILLACS

SKU: TS31101

Oil Primer Tool for '66 and up Cadillacs

[Read More](#)

Price: \$25.00

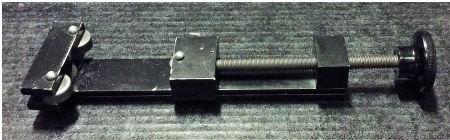

TS31004 OIL FILTER CUTOFF TOOL

SKU: TS31004

Professional Grade

[Read More](#)

Price: \$85.00



TS11209 EXHAUST BOLT REMOVAL TOOL KIT

SKU: TS11209

Manibolt Driller tool / fixture kit, makes removing broken bolts a 'snap', often without pulling the heads or engine out of the car.

With this precision tool you can drill and tap broken exhaust manifold bolts dead center and perfectly straight, every time, even if you can't see where you're drilling!

This kit fits all '68-'85 Cadillac 472 / 500 / 425 / 368 Cadillac engines.

Kit includes: Bushing Clamp (Qty 3, sizes 1/8 1/4 and 5/16), Drills and Taps (Qty 1 ea. 1/8 1/4 and 5/16 with 3/8-16 Tap), Knurled Thumbscrew for mounting Bushing Clamps, Modified 3/8-16 Stainless Flatheads (Qty 4), and a Rugged plastic case with laser cut foam fitted for dedicated placement.

For more information, see the detailed info tab.

You can also visit Beydler's website [here](#) for how-to videos and more.

[Read More](#)



505-823-9340
8333 JEFFERSON NE
ALBUQUERQUE, NM 87113
CADILLACPERFORMANCE.COM

Price: \$450.00

VALVE COVERS



VT95332 CHROME VALVE COVER BREATHER (W/ PCV TUBE)

SKU: VT95332

Chrome Push-In Valve Cover Breather With integrated PCV valve

[Read More](#)

Price: \$25.00



VT95331 BILLET ALUMINUM VALVE COVER BREATHER (W/ PCV VALVE)

SKU: VT95331

Billet Aluminum Push-In Valve Cover Breather With integrated PCV valve

[Read More](#)

Price: \$70.00





VT95212 CHROME VALVE COVER BREATHER W/ HOSE NIPPLE

SKU: VT95212

Chrome Push-In Valve Cover Breather w/ Hose Nipple

for PCV hose (requires in-line PCV valve) or for connecting breather to air cleaner housing.

[Read More](#)

Price: \$11.00



VT95111 BILLET ALUMINUM VALVE COVER BREATHER

SKU: VT95111

Billet Aluminum Push-In Valve Cover Breather

[Read More](#)

Price: \$55.00



VT93232 BAFFLED PCV GROMMET

SKU: VT93232

For installing a PCV valve directly into an un-baffled valve cover

[Read More](#)

Price: \$10.00

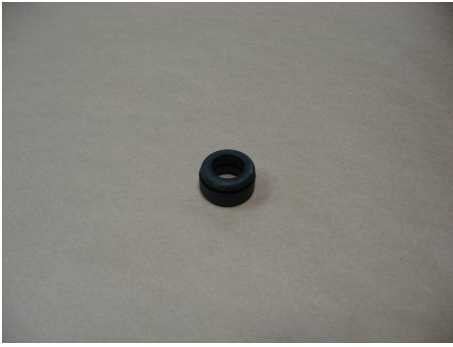

VT93033 GROMMET FOR AIR CLEANER HOUSING

SKU: VT93033

[Read More](#)

Price: \$5.00



VT93032 OE STYLE 90 DEGREE PCV GROMMET

SKU: VT93032

OE Style 90 Degree PCV Grommet

[Read More](#)

Price: \$15.00



VT93031 VALVE COVER GROMMET

SKU: VT93031

[Read More](#)

Price: \$7.00

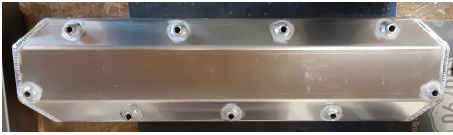

VT91161 FABRICATED ALUMINUM VALVE COVERS

SKU: VT91131-1

Cad Company Fabricated Aluminum Valve Covers

The premium fabricated valve covers feature billet aluminum gasket rails for a superior seal, and area available with polished stainless steel hex bolts or ARP polished stainless 12-point bolts, with washers.

Provided with no breather holes to allow you to put them where you want.

[Read More](#)

Price: \$550.00 - \$650.00



VT91151 FLAT TOP VALVE COVERS WITH RAISED EARLY CADILLAC SCRIPT AND FINS

SKU: VT91151

3¼" tall. Raised GM Licensed 50's style Cadillac script and fins. No need to



worry about oil leaks from distorted gasket surfaces with these full width covers. Provided with no breather holes to allow you to put them where you want. Stainless fasteners included.

[Read More](#)

Price: ~~\$585.00~~ \$520.00



VT91131 FLAT TOP VALVE COVERS WITH RAISED CADILLAC SCRIPT

SKU: VT91131

3¼" tall. Raised GM Licensed 70's style Cadillac script. No need to worry about oil leaks from distorted gasket surfaces with these full width covers. Provided with no breather holes to allow you to put them where you want. Stainless fasteners included.

[Read More](#)

Price: ~~\$585.00~~ \$520.00



VT91111 FLAT TOP VALVE COVERS

SKU: VT91111

3¼" tall. They've got an extra thick top, should you choose to engrave them. No need to worry about oil leaks from distorted gasket surfaces with these full width covers. Provided with no breather holes to allow you to put them where you want. Stainless fasteners included.

[Read More](#)

Price: ~~\$528.00~~ \$475.00



VT91101 CHROME VALVE COVERS

SKU: VT91101

These inexpensive chrome covers add a touch of class to your Cad.

[Read More](#)

Price: \$45.00

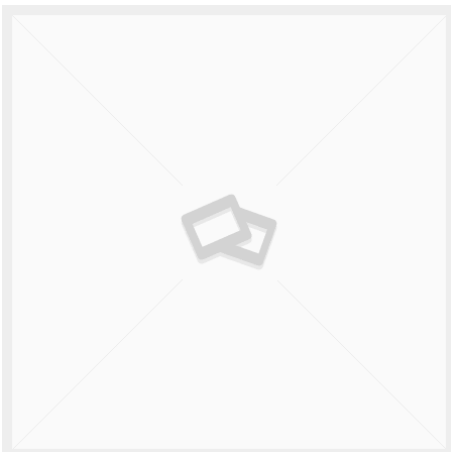

VT91021 CUSTOM VALVE COVERS POWDER COATING

SKU: VT91021

Powder Coating \$175 and up

[Read More](#)

Price: \$175.00



VT90203 STUD AND NUT KIT BLACK OXIDE

SKU: VT90203

Stud and Nut Kit Black Oxide

[Read More](#)

Price: \$30.00



VT90202 VALVE COVER STUD AND NUT KIT, STAINLESS

SKU: VT90202

Stainless Stud and Nut kit for OE or chrome valve covers

[Read More](#)

Price: \$35.00



KVT91221 FINNED VALLEY COVER 1949-1967

SKU: kVT91221

[Read More](#)

Price: \$175.00

-16%



KVT91111 CADILLAC CAST ALUMINUM VALVE COVERS - OFFENHAUSER SCRIPT CALL TO ORDER

SKU: kVT91111

Finned Aluminum Valve Covers

[Read More](#)

Price: ~~\$745.00~~ \$625.00



KVT91103 POWDER COATED CADILLAC SCRIPT COVERS 1949-1967

SKU: kVT91103

Fins and Script valve covers for '50-'67 331, 365, 390, and 429 engines. Powder coated black with top of fins and script polished back to bare aluminum. Really stands out.

[Read More](#)

Price: \$775.00



KVT91102 POLISHED CADILLAC SCRIPT VALVE COVERS 331/365/390/429

SKU: kVT91102

[Read More](#)

Price: \$895.00



KVT91101 CADILLAC SCRIPT VALVE COVERS 331-429

SKU: kVT91101

[Read More](#)

Price: \$575.00

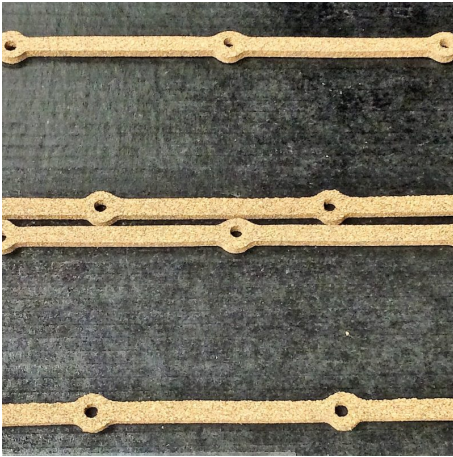

GS51612 CAD COMPANY 2X VALVE COVER GASKETS

SKU: GS51612

**Cad Company 2X valve cover gaskets
Double thick nylon impregnated cork**

[Read More](#)

Price: \$40.00

BITS AND PIECES



VT95332 CHROME VALVE COVER BREATHER (W/ PCV TUBE)

SKU: VT95332

Chrome Push-In Valve Cover Breather With integrated PCV valve

[Read More](#)

Price: \$25.00



VT95331 BILLET ALUMINUM VALVE COVER BREATHER (W/ PCV VALVE)

SKU: VT95331

Billet Aluminum Push-In Valve Cover Breather With integrated PCV valve

[Read More](#)

Price: \$70.00





VT95212 CHROME VALVE COVER BREATHER W/ HOSE NIPPLE

SKU: VT95212

Chrome Push-In Valve Cover Breather w/ Hose Nipple

for PCV hose (requires in-line PCV valve) or for connecting breather to air cleaner housing.

[Read More](#)

Price: \$11.00



VT95111 BILLET ALUMINUM VALVE COVER BREATHER

SKU: VT95111

Billet Aluminum Push-In Valve Cover Breather

[Read More](#)

Price: \$55.00



VT93232 BAFFLED PCV GROMMET

SKU: VT93232

For installing a PCV valve directly into an un-baffled valve cover

[Read More](#)

Price: \$10.00

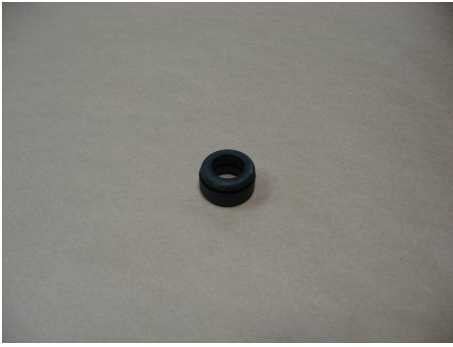

VT93033 GROMMET FOR AIR CLEANER HOUSING

SKU: VT93033

[Read More](#)

Price: \$5.00



VT93032 OE STYLE 90 DEGREE PCV GROMMET

SKU: VT93032

OE Style 90 Degree PCV Grommet

[Read More](#)

Price: \$15.00



VT90203 STUD AND NUT KIT BLACK OXIDE

SKU: VT90203

Stud and Nut Kit Black Oxide

[Read More](#)

Price: \$30.00



VT90202 VALVE COVER STUD AND NUT KIT, STAINLESS

SKU: VT90202

Stainless Stud and Nut kit for OE or chrome valve covers

[Read More](#)

Price: \$35.00

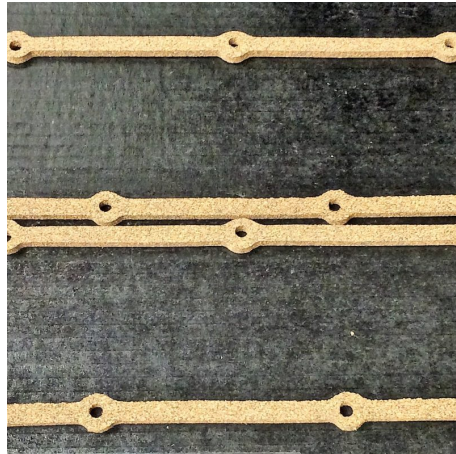

GS51612 CAD COMPANY 2X VALVE COVER GASKETS

SKU: GS51612

**Cad Company 2X valve cover gaskets
Double thick nylon impregnated cork**

[Read More](#)

Price: \$40.00

CAST ALUMINUM VALVE COVERS

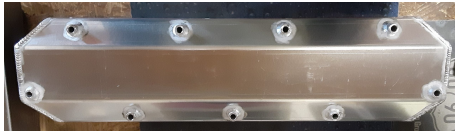

VT91161 FABRICATED ALUMINUM VALVE COVERS

SKU: VT91131-1

Cad Company Fabricated Aluminum Valve Covers

The premium fabricated valve covers feature billet aluminum gasket rails for a superior seal, and area available with polished stainless steel hex bolts or ARP polished stainless 12-point bolts, with washers.

Provided with no breather holes to allow you to put them where you want.

[Read More](#)

Price: \$550.00 - \$650.00



VT91151 FLAT TOP VALVE COVERS WITH RAISED EARLY CADILLAC SCRIPT AND FINS

SKU: VT91151

3¼" tall. Raised GM Licensed 50's style Cadillac script and fins. No need to



MADE IN THE U.S.A.

worry about oil leaks from distorted gasket surfaces with these full width covers. Provided with no breather holes to allow you to put them where you want. Stainless fasteners included.

[Read More](#)

Price: \$585.00 ~~\$520.00~~



VT91131 FLAT TOP VALVE COVERS WITH RAISED CADILLAC SCRIPT

SKU: VT91131

3¼" tall. Raised GM Licensed 70's style Cadillac script. No need to worry about oil leaks from distorted gasket surfaces with these full width covers. Provided with no breather holes to allow you to put them where you want. Stainless fasteners included.

[Read More](#)

Price: ~~\$585.00~~ \$520.00



VT91111 FLAT TOP VALVE COVERS

SKU: VT91111

3¼" tall. They've got an extra thick top, should you choose to engrave them. No need to worry about oil leaks from distorted gasket surfaces with these full width covers. Provided with no breather holes to allow you to put them where you want. Stainless fasteners included.

[Read More](#)

Price: ~~\$528.00~~ \$475.00

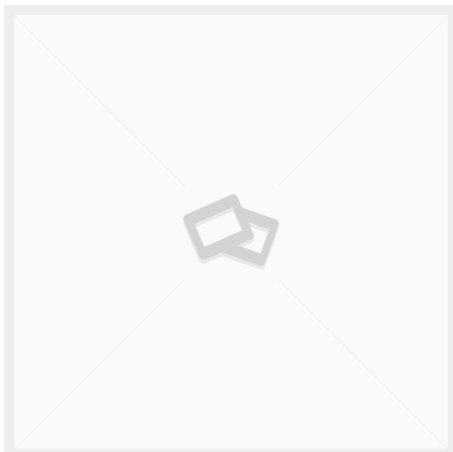

VT91021 CUSTOM VALVE COVERS POWDER COATING

SKU: VT91021

Powder Coating \$175 and up

[Read More](#)

Price: \$175.00

CHROME VALVE COVERS



VT91101 CHROME VALVE COVERS

SKU: VT91101

These inexpensive chrome covers add a touch of class to your Cad.

[Read More](#)

Price: \$45.00

EARLY CADILLAC VALVE COVERS



KVT91221 FINNED VALLEY COVER 1949-1967

SKU: kVT91221

[Read More](#)

Price: \$175.00



KVT91111 CADILLAC CAST ALUMINUM VALVE COVERS - OFFENHAUSER SCRIPT CALL TO ORDER

SKU: kVT91111

Finned Aluminum Valve Covers

[Read More](#)

Price: ~~\$745.00~~ \$625.00



KVT91103 POWDER COATED CADILLAC SCRIPT COVERS 1949-1967

SKU: kVT91103

Fins and Script valve covers for '50-'67 331, 365, 390, and 429 engines. Powder coated black with top of fins and script polished back to bare aluminum. Really stands out.

[Read More](#)

Price: \$775.00



KVT91102 POLISHED CADILLAC SCRIPT VALVE COVERS 331/365/390/429

SKU: kVT91102

[Read More](#)

Price: \$895.00



KVT91101 CADILLAC SCRIPT VALVE COVERS 331-429

SKU: kVT91101

[Read More](#)

Price: \$575.00

VALVETRAIN

The valvetrain is an important part of any engine combination. Whether your engine is stock or full race, or anything in between, having a correctly matched, properly functioning valve train is of equal importance. If you are not sure which components are right for your engine, feel free to send us an e-mail or give us a call for a recommendation. Below you will find a variety of valves, springs, seals, and other timing components to put together a first class valvetrain.



VT75113 OVER-LENGTH OE REPLACEMENT PUSHRODS CUSTOM ONLY

SKU: VT75113

Available in +.030"

[Read More](#)

Price: \$276.00



VT75112 HD STOCK REPLACEMENT PUSHROD (SET OF 16)

SKU: VT75112

HD Stock Replacement Pushrod (set of 16)

Heavy Duty thick wall Chromoly.

Stock length (10.200") Fits '68-'85 472 / 500 / 425 / 368 engines except 4-6-8 with OEM or newer Stage 3 rockers.

Made in USA

[Read More](#)

Price: \$295.00





VT75111 OE REPLACEMENT PUSHRODS (SET OF 16)

SKU: VT75111

OE Replacement Pushrods OE or Stage III A Rockers (set of 16)

[Read More](#)

Price: \$75.00



VT75102 HD STOCK REPLACEMENT PUSHROD (SINGLE)

SKU: VT75102

HD Stock Replacement Pushrod (single)

Heavy Duty thick wall Chromoly.

Stock length (10.200") Fits '68-'85 472 / 500 / 425 / 368 engines except 4-6-8 with OEM or newer Stage 3 rockers.

Made in USA

[Read More](#)

Price: \$15.00



VT75011 CUSTOM CHROMOLY PUSHRODS

SKU: VT75011

any size \$175 and up

[Read More](#)

Price: \$225.00



VT75001 ADJUSTABLE PUSHROD

SKU: VT75001

Full credit towards custom pushrods upon return.

[Read More](#)

Price: \$35.00



VT73104 RETAINING CLIPS (MOUSE TRAPS)

SKU: yVT73104

4 per engine. note: good used OEM clips

[Read More](#)

Price: \$20.00



VT73103 EXHAUST ROCKERS 1.65:1

SKU: VT73103

8 per engine, new

[Read More](#)

Price: \$30.00



VT73102 INTAKE ROCKERS 1.65:1

SKU: VT73102

8 per engine, new

[Read More](#)

Price: \$30.00



VT73101 T-PEDESTALS - AFTERMARKET

SKU: VT73101

8 per engine, new

Aftermarket pedestals, tougher than stock for increased reliability.

[Read More](#)

Price: \$30.00



VT71770 BOOGIEMAN PRO COMP ROLLER ROCKERS

SKU: VT71770

PRO COMP ROLLER ROCKERS



Adjustable Full Shaft Roller Rockers

Premium roller rocker setup for solid cams. Roller tip shaft rockers, with roller trunnions, individually adjustable, with a full girdle, suitable for builds at all levels of performance with a solid cam. For BoogieMan heads.

[Read More](#)

Price: \$2,087.40



**MADE IN
THE U.S.A.**

VT71730 PRO COMP ROLLER ROCKERS

SKU: VT71730

PRO COMP ROLLER ROCKERS



**MADE IN
THE U.S.A.**

Adjustable Full Shaft Roller Rockers

Premium roller rocker setup for solid cams. Roller tip shaft rockers, with roller trunnions, individually adjustable, with a full girdle, suitable for builds at all levels of performance with a solid cam. For iron or Bulldog / FR aluminum heads.

[Read More](#)

Price: \$1,491.16

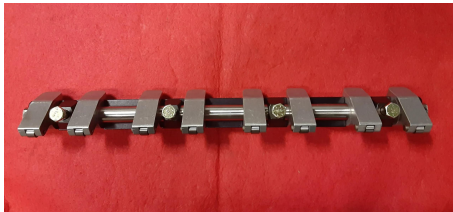

VT71710 PRO STREET ROLLER ROCKERS

SKU: VT71710

PRO STREET ROLLER ROCKERS



**MADE IN
THE U.S.A.**

Non-Adjustable Full Shaft Roller Rockers

Premium roller rocker setup for hydraulic cams. Roller tip shaft rockers, non-adjustable, with a full girdle, suitable for builds at all levels of performance without a solid cam. For iron or Bulldog / FR aluminum heads.

[Read More](#)

Price: \$1,182.50



**MADE IN
THE U.S.A.**

VT71440 STAGE IV SS (1.73:1) ADJUSTABLE ROLLER TIP SHAFT ROCKER ASSEMBLY

SKU: VT71440

Stage IV SS (1.73:1) Adjustable Roller Tip Shaft Rocker Assembly with Stainless Steel rocker arms.

[Read More](#)

Price: \$1,695.00



VT71420 STAGE IV (1.73:1) ADJUSTABLE ROLLER TIP SHAFT ROCKER ASSEMBLY

SKU: VT71420

Stage IV (1.73:1) Adjustable Roller Tip Shaft Rocker Assembly

[Read More](#)

Price: \$1,523.82



VT71310 STAGE III (1.72:1) SHAFT ROCKER ASSEMBLY USES STOCK PUSHRODS

SKU: VT71310

Stage III (1.72:1) Shaft Rocker Assembly uses stock pushrods

[Read More](#)

Price: \$973.84



VT71101 OEM ROCKER COMPONENTS FULL SET

SKU: VT71101

Complete set of 8 new intake rockers, 8 new exhaust rockers, 8 new T-Pedestals, and 4 good original sheet metal retaining clips.

[Read More](#)

Price: \$425.00



VT53702 120CC (472 / 500) AND 425 2.19 / 1.85 STAINLESS VALVES

SKU: VT53702

120cc and 425 2.19 / 1.85 SS Valves

For ported heads.

[Read More](#)

Price: \$325.00



VT53701 120CC (472 / 500) AND 425 2.11 / 1.77 STAINLESS VALVES

SKU: VT53701

120cc and 425 2.11 / 1.77 SS Valves

For ported heads.

[Read More](#)

Price: ~~\$295.00~~ \$275.00



VT53301 120CC (472 / 500) AND 425 REPLACEMENT VALVES

SKU: VT53301

120cc Stock Size Valves

for unleaded fuel.

[Read More](#)

Price: \$195.00



VT51702 76CC 2.25 / 1.90 STAINLESS VALVES

SKU: VT51702

76cc 2.25 / 1.90 SS Valves

For high-end applications that call for full-port heads.

[Read More](#)

Price: \$350.00



VT51701 76CC 2.19 / 1.90 STAINLESS VALVES

SKU: VT51701

76cc 2.19 / 1.90 SS Valves

For ported heads.

[Read More](#)

Price: \$325.00



VT51301 76CC REPLACEMENT VALVES

SKU: VT51301

76cc Stock Size Valves

for unleaded fuel.

[Read More](#)

Price: \$195.00



VT37012 VITON UMBRELLA VALVE STEM SEALS

SKU: VT37012

Viton Umbrella Valve Stem Seals

[Read More](#)

Price: \$20.00



VT33114 VALVE SPRING KITS STAGE 4

SKU: VT33114

Oversized HD dual performance springs
Up to .720 lift.

[Read More](#)

Price: \$250.00



VT33113 VALVE SPRING KITS STAGE 3

SKU: VT33113

Small diameter high performance springs
Up to .600 lift.

[Read More](#)

Price: \$250.00



VT33112 VALVE SPRING KITS STAGE 2

SKU: VT33112

Oversized high performance springs
Up to .600 lift.

[Read More](#)

Price: \$150.00



VT33111 VALVE SPRING KITS STAGE 1

SKU: VT33111

OE size performance springs
Up to .550 lift.

[Read More](#)

Price: \$105.00



VT31112 LIFTERS - FLAT TAPPET HYDRAULIC FOR 472, 500, 425, 368, AND '67 429

SKU: VT31112

Flat Tappet Hydraulic Lifters - nothing special, just good quality and correct fit. Set of 16

Made in the USA

[Read More](#)

Price: \$175.00



VT27011 ROLLER CAMS CUSTOM SOLID ROLLER KITS FROM \$2195

SKU: VT27011

CAM KIT

PER APPLICATION RPM

Custom Solid Roller Kits from \$2195

Call (505) 823-9340 for estimate on your vehicle's application

[Read More](#)

Price: \$2,195.00



VT26651 R 650 H RADICAL HYDRAULIC ROLLER: ROLLER VERSION OF THE PC650H KIT

SKU: VT26651

CAM KIT

3500-7000 RPM

Radical Hydraulic Roller: Roller version of the PC650H

[Read More](#)

Price: \$2,517.32



VT26650 R 650 H RADICAL HYDRAULIC ROLLER: ROLLER VERSION OF THE PC650H

SKU: VT26650

CAM ONLY

3500-7000 RPM

Radical Hydraulic Roller: Roller version of the PC650H

[Read More](#)

Price: \$1,077.31



VT26541 R 540 H BUDGET BRACKET RACING, STREET STOMPERS; OVAL TRACK @ 11:1 (STOCK, MODIFIED, IMCA) KIT

SKU: VT26541

CAM KIT

2800-6000 RPM

Budget Bracket Racing, Street Stompers; Oval Track @ 11:1 (Stock, Modified, IMCA)

[Read More](#)

Price: \$2,288.53



VT26540 R 540 H BUDGET BRACKET RACING, STREET STOMPERS; OVAL TRACK @ 11:1 (STOCK, MODIFIED, IMCA)

SKU: VT26540

CAM ONLY

2800-6000 RPM

Budget Bracket Racing, Street Stompers; Oval Track @ 11:1 (Stock, Modified, IMCA)

[Read More](#)

Price: \$979.38



VT26351 HIGH COMPRESSION (10:1 OR MORE) HOT-ROD STREET PERFORMANCE HYDRAULIC ROLLER CAM KIT R350H

SKU: VT26351

CAM KIT

2600-5800 RPM

High compression (10:1 or more) hot-rod street performance hydraulic roller cam.

Hot rods, gear box airboats, etc. Good ignition and exhaust recommended. OK Idle, Good choice for truly streetable performance. Cad Company hydraulic roller cams eliminate wear issues and are worth ~20-30 HP over the flat tappet version, with similar idle quality and RPM range.

[Read More](#)

Price: \$2,288.53



VT26350 R 350 H HIGH COMPRESSION (10:1 OR MORE) HOT-ROD STREET PERFORMANCE HYDRAULIC ROLLER CAM

SKU: VT26350

CAM ONLY

2600-5800 RPM

High compression (10:1 or more) hot-rod street performance hydraulic roller cam.

Hot rods, gear box airboats, etc. Good ignition and exhaust recommended. OK Idle, Good choice for truly streetable performance. Cad Company hydraulic roller cams eliminate wear issues and are worth ~20-30 HP over the flat tappet version, with similar idle quality and RPM range.

[Read More](#)

Price: \$979.38



VT26276R MILD STREET PERFORMANCE HYDRAULIC ROLLER CAM KIT R 275 H

SKU: VT26276

CAM KIT

2200-5200 RPM

Mild street performance hydraulic roller cam.
Hot rods, gear box airboats, etc. Fair Idle, Good choice for truly streetable performance.

Cad Company hydraulic roller cams eliminate wear issues and are worth ~20-30 HP over the flat tappet version, with similar idle quality and RPM range.

[Read More](#)

Price: \$2,288.53



VT26275 MILD STREET PERFORMANCE HYDRAULIC ROLLER CAM R 275 H

SKU: VT26275

CAM ONLY

2200-5200 RPM

Mild street performance hydraulic roller cam.
Hot rods, gear box airboats, etc. Fair Idle, Good choice for truly streetable performance.

Cad Company hydraulic roller cams eliminate wear issues and are worth ~20-30 HP over the flat tappet version, with similar idle quality and RPM range.

[Read More](#)

Price: \$979.38

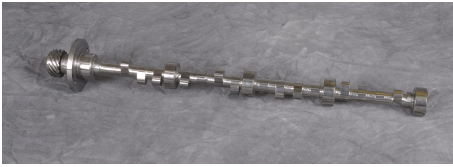

VT26011 ROLLER CAMS CUSTOM HYDRAULIC ROLLER KITS FROM \$2288

SKU: VT26011

CAM KIT

PER APPLICATION RPM

Roller Cams Custom Hydraulic Roller Kits from \$2288

[Read More](#)

Price: \$2,288.53



VT25651 PRO/CAD 650 S OUR MOST POPULAR SOLID FLAT TAPPET RACE CAM KIT

SKU: VT25651

CAM KIT

3000-6500 RPM

Our most popular flat tappet solid race cam. For iron head non-roller combos, this cam is king of the hill.

[Read More](#)

Price: \$649.00



VT25650 PRO/CAD 650 S OUR MOST POPULAR SOLID FLAT TAPPET RACE CAM

SKU: VT25650

CAM ONLY

3000-6500 RPM

Our most popular flat tappet solid race cam. For iron head non-roller combos, this cam is king of the hill.

[Read More](#)

Price: \$415.00



VT25010 SOLID CAMS CUSTOM SOLID KITS FROM \$595

SKU: VT25010

CAM KIT

PER APPLICATION RPM

Solid Cams

Custom Solid Kits from \$595

[Read More](#)

Price: \$595.00



VT23651 PRO/CAD 650 H CAM KIT - RADICAL HYDRAULIC; THE BADDEST FLAT TAPPET HYDRAULIC YOU CAN GET

SKU: VT23651

CAM KIT

3500-6500 RPM

Radical Hydraulic: The baddest flat tappet hydraulic you can get

[Read More](#)

Price: \$830.16



VT23650 PRO/CAD 650 H CAMSHAFT - RADICAL HYDRAULIC; THE BADDEST FLAT TAPPET HYDRAULIC YOU CAN GET

SKU: VT23650

CAM ONLY

3500-6500 RPM

Radical Hydraulic: The baddest flat tappet hydraulic you can get

[Read More](#)

Price: \$493.27



VT23641 PRO/CAD 640 H CAM KIT - VERY STRONG HYDRAULIC; PRO/STREET STROKERS; BRACKET RACING; TRACTOR PULLS

SKU: VT23641

CAM KIT

3200-6800 RPM

Very strong hydraulic: PRO/Street Stokers; Bracket Racing; Tractor Pulls KIT

[Read More](#)

Price: \$830.16



VT23640 PRO/CAD 640 H CAMSHAFT - VERY STRONG HYDRAULIC; PRO/STREET STROKERS; BRACKET RACING; TRACTOR PULLS

SKU: VT23640

CAM ONLY

3200-6800 RPM

Very strong hydraulic: PRO/Street Stokers; Bracket Racing; Tractor Pulls

[Read More](#)

Price: \$493.27



VT23626 PRO/CAD 625 H CAM KIT - VERY STRONG HYDRAULIC; PRO/STREET STROKERS; BRACKET RACING; TRACTOR PULLS

SKU: VT23626

CAM KIT

3200-6800 RPM

Very strong hydraulic: PRO/Street Stokers; Bracket Racing; Tractor Pulls

[Read More](#)

Price: \$813.89



VT23625 PRO/CAD 625 H CAMSHAFT - VERY STRONG HYDRAULIC; PRO/STREET STROKERS; BRACKET RACING; TRACTOR PULLS

SKU: VT23625

CAM ONLY

3200-6800 RPM

Very strong hydraulic: PRO/Street Stokers; Bracket Racing; Tractor Pulls

[Read More](#)

Price: \$477.68



VT23601 PRO/CAD 600 H CAM KIT - VERY STRONG HYDRAULIC; PRO/STREET; BRACKET RACING; ASPHALT OVAL TRACK

SKU: VT23601

CAM KIT

3000-6500 RPM

Very strong hydraulic: PRO/Street; Bracket Racing; Asphalt Oval Track

[Read More](#)

Price: \$813.89



VT23600 PRO/CAD 600 H CAMSHAFT - VERY STRONG HYDRAULIC; PRO/STREET; BRACKET RACING; ASPHALT OVAL TRACK

SKU: VT23600

CAM ONLY

3000-6500 RPM

Very strong hydraulic: PRO/Street; Bracket Racing; Asphalt Oval Track

[Read More](#)

Price: \$477.68



VT23541 PRO/CAD 540 H CAM KIT - BUDGET BRACKET RACING, STREET STOMPERS; OVAL TRACK @ 11:1 (STOCK, MODIFIED, IMCA)

SKU: VT23541

CAM KIT

2600-5800 RPM

Budget Bracket Racing, Street Stompers; Oval Track @ 11:1 (Stock, Modified, IMCA)

[Read More](#)

Price: \$813.89



VT23540 PRO/CAD 540 H CAMSHAFT - BUDGET BRACKET RACING, STREET STOMPERS; OVAL TRACK @ 11:1 (STOCK, MODIFIED, IMCA)

SKU: VT23540

CAM ONLY

2800-6000 RPM

Budget Bracket Racing, Street Stompers; Oval Track @ 11:1 (Stock, Modified, IMCA)

[Read More](#)

Price: \$477.68



VT23206 PRO/CAD 205 H CAM KIT - CRUISER / BUDGET HOT ROD

SKU: VT23206

CAM KIT

2000-4200 RPM

Cruiser / budget hot rod cam

Mild Hot Rods, Cruisers. Mild cam with hot rod idle. More power than the SS205H, in the same RPM range, and safe with Stage 1 rockers.

This cam is ideal for making absolute maximum torque you can get at 3000 RPM.

[Read More](#)

Price: \$642.92



VT23205 PRO/CAD 205 H CAMSHAFT - CRUISER / BUDGET HOT ROD

SKU: VT23205

CAM ONLY

2000-4200 RPM

Cruiser / budget hot rod cam

Mild Hot Rods, Cruisers. Mild cam with hot rod idle. More power than the SS205H, in the same RPM range, and safe with Stage 1 rockers.

This cam is ideal for making absolute maximum torque you can get at 3000 RPM.

[Read More](#)

Price: \$462.68



VT23121 PRO/CAD 120 H CAM KIT - MILD HOT ROD / DIRECT DRIVE AIRBOAT

SKU: VT23121

PC120H CAM KIT

1500-4200 RPM

This cam is ideal for making the absolute maximum torque you can get at 3000 RPM.

The best lopey-idle cam for an other wise stock engine, stock rockers are generally reliable with this cam (assuming they're in good condition).

[Read More](#)

Price: \$642.92



VT23120 PRO/CAD 120 H CAMSHAFT

SKU: VT23120

CAM ONLY

1500-4200 RPM

This cam is ideal for making the absolute maximum torque you can get at 3000 RPM.

The best lopey-idle cam for an other wise stock engine, stock rockers are generally reliable with this cam (assuming they're in good condition).

[Read More](#)

Price: \$462.68



VT22301 SS 300 H CAM KIT - HIGH COMPRESSION (10:1 OR MORE) HOT-ROD STREET PERFORMANCE

SKU: VT22301

CAM KIT

2400-5500 RPM

High compression (10:1 or more) hot-rod street performance cam. Hot rods, gear box airboats, etc. Good ignition and exhaust recommended. OK Idle, Good choice for truly streetable performance.

[Read More](#)

Price: \$712.08



VT22300 SS 300 H HIGH COMPRESSION (10:1 OR MORE) HOT-ROD STREET PERFORMANCE CAM SS 300 H

SKU: VT22300

CAM ONLY

2400-5500 RPM

High compression (10:1 or more) hot-rod street performance cam. Hot rods, gear box airboats, etc. Good ignition and exhaust recommended. OK Idle, Good choice for truly streetable performance.

[Read More](#)

Price: \$447.32



VT22276 SS 275 H CAM KIT - HIGH COMPRESSION (10:1 OR MORE) MILD STREET PERFORMANCE

SKU: VT22276

CAM KIT

2200-5200 RPM

High compression (10:1 or more) mild street performance cam. Hot rods, gear box airboats, etc. Fair Idle, Good choice for truly streetable performance.

[Read More](#)

Price: \$712.08



VT22275 SS 275 H CAMSHAFT - HIGH COMPRESSION (10:1 OR MORE) MILD STREET PERFORMANCE

SKU: VT22275

CAM ONLY

2200-5200 RPM

High compression (10:1 or more) mild street performance cam. Hot rods, gear box airboats, etc. Fair Idle, Good choice for truly streetable performance.

[Read More](#)

Price: \$447.32



VT22251 SS 250 H CAM KIT - HIGH COMPRESSION (10:1 OR MORE) MILD STREET PERFORMANCE

SKU: VT22251

CAM KIT

2200-5000 RPM

High compression (10:1 or more) mild street performance cam. Hot rods, gear box airboats, etc. Fair Idle, Good choice for truly streetable performance.

[Read More](#)

Price: \$712.08



VT22250 SS 250 H CAMSHAFT - HIGH COMPRESSION (10:1 OR MORE) MILD STREET PERFORMANCE

SKU: VT22250

CAM ONLY

2200-5000 RPM

High compression (10:1 or more) mild street performance cam. Hot rods, gear box airboats, etc. Fair Idle, Good choice for truly streetable performance.

[Read More](#)

Price: \$447.32



VT22206 SS 205 H CAM KIT - HIGH COMPRESSION (10:1 OR MORE)

SKU: VT22206

SS205H CAM KIT

2000-4200 RPM

High compression (10:1 or more) RV cam.
Restoration, Towing, Mild Hot Rods, Cruisers. Good Idle.

[Read More](#)

Price: \$627.56



VT22205 SS 205 H CAMSHAFT - HIGH COMPRESSION (10:1 OR MORE)

SKU: VT22205

SS205H CAM ONLY

2000-4200 RPM

High compression (10:1 or more) RV cam.
Restoration, Towing, Mild Hot Rods, Cruisers. Good Idle.

[Read More](#)

Price: \$447.32



VT22121 SS 120 H CAM KIT - HIGH COMPRESSION (10:1 OR MORE)

SKU: VT22121

CAM KIT

1800-4200 RPM

High compression (10:1 or more) RV cam.
Restoration, Towing, Direct Drive Airboat. Near stock idle quality, Best all around choice for low RPM applications.
Note: This cam is designed to idle well as low as 450 RPM, for those that need that feature.

Kit Pricing is for the Camshaft, as well as appropriate lifters, springs, retainers, locks, and valve stem seals. Cams generally come with a complimentary single-serving-size cam lube as available.

[Read More](#)

Price: \$627.56



VT22120 SS 120 H CAMSHAFT HIGH COMPRESSION (10:1 OR MORE) RV

SKU: VT22120

CAM ONLY

1800-4200 RPM

High compression (10:1 or more) RV cam. Restoration, Towing, Direct Drive Airboat. Near stock idle quality, Best all around choice for low RPM applications. Note: This cam is designed to idle well as low as 450 RPM, for those that need that feature.

[Read More](#)

Price: \$447.32



VT21301 CTA 300 H CAM KIT - LOW COMPRESSION (9.2:1 OR LESS) HOT-ROD STREET PERFORMANCE

SKU: VT21301

CAM KIT

2400-5500 RPM

Low compression (9.2:1 or less) hot-rod street performance cam. Hot rods, gear box airboats, etc. Good ignition and exhaust recommended. OK Idle, Good choice for truly streetable performance.

[Read More](#)

Price: \$712.08



VT21300 CTA 300 H CAMSHAFT - LOW COMPRESSION (9.2:1 OR LESS) HOT-ROD STREET PERFORMANCE

SKU: VT21300

CAM ONLY

2400-5500 RPM

Low compression (9.2:1 or less) hot-rod street performance cam. Hot rods, gear box airboats, etc. Good ignition and exhaust recommended. OK Idle, Good choice for truly streetable performance.

[Read More](#)

Price: \$462.68



VT21276 CTA 275 H CAM KIT - LOW COMPRESSION (9.2:1 OR LESS) MILD STREET PERFORMANCE

SKU: VT21276

CAM KIT

2200-5200 RPM

Low compression (9.2:1 or less) mild street performance cam. Hot rods, gear box airboats, etc. Fair Idle, Good choice for truly streetable performance.

[Read More](#)

Price: \$712.08



VT21275 CTA 275 H CAMSHAFT - LOW COMPRESSION (9.2:1 OR LESS) MILD STREET PERFORMANCE

SKU: VT21275

CAM ONLY

2200-5200 RPM

Low compression (9.2:1 or less) mild street performance cam. Hot rods, gear box airboats, etc. Fair Idle, Good choice for truly streetable performance.

[Read More](#)

Price: \$462.68



VT21251 CTA 250 H CAM KIT - LOW COMPRESSION (9.2:1 OR LESS) MILD STREET PERFORMANCE

SKU: VT21251

CAM KIT

2200-5000 RPM

Low compression (9.2:1 or less) mild street performance cam. Hot rods, gear box airboats, etc. Fair Idle, Good choice for truly streetable performance.

[Read More](#)

Price: \$712.08



VT21250 CTA 250 H CAMSHAFT - LOW COMPRESSION (9.2:1 OR LESS) MILD STREET PERFORMANCE

SKU: VT21250

CAM ONLY

2200-5000 RPM

Low compression (9.2:1 or less) mild street performance cam. Hot rods, gear box airboats, etc. Fair Idle, Good choice for truly steerable performance.

[Read More](#)

Price: \$462.68



VT21206 CTA 205 H CAM KIT - LOW COMPRESSION (9.2:1 OR LESS)

SKU: VT21206

CAM KIT

2000-4200 RPM

Low compression (9.2:1 or less) RV cam. Restoration, Towing, Mild Hot Rods, Cruisers. Good Idle.

[Read More](#)

Price: \$627.56



VT21205 CTA 205 H CAMSHAFT - LOW COMPRESSION (9.2:1 OR LESS)

SKU: VT21205

CAM ONLY

2000-4200 RPM

Low compression (9.2:1 or less) RV cam.
Restoration, Towing, Mild Hot Rods, Cruisers. Good Idle.

[Read More](#)

Price: \$447.32



VT21121 CTA 120 H CAM KIT - LOW COMPRESSION (9.2:1 OR LESS)

SKU: VT21121

CAM KIT

1800-4200 RPM

Low compression (9.2:1 or less) RV cam.
Restoration, Towing, Direct Drive Airboat. Near stock idle quality, Best all around choice for low RPM applications.
Note: This cam is designed to idle well as low as 450 RPM, for those that need that feature.

Kit Pricing is for the Camshaft, as well as appropriate lifters, springs, retainers, locks, and valve stem seals. Cams generally come with a complimentary single-serving-size cam lube as available.

[Read More](#)

Price: \$627.56



VT21120 CTA 120 H CAMSHAFT - LOW COMPRESSION (9.2:1 OR LESS)

SKU: VT21120

CAM ONLY

1800-4200 RPM

Low compression (9.2:1 or less) RV cam.
Restoration, Towing, Direct Drive Airboat. Near stock idle quality, Best all around choice for low RPM applications.
Note: This cam is designed to idle well as low as 450 RPM, for those that need that feature.

[Read More](#)

Price: \$447.32



VT20350 SS 350 H CAMSHAFTS AND KITS - HIGH COMPRESSION (10:1 OR MORE) HOT-ROD STREET PERFORMANCE

SKU: VT20350

350 H series camshaft

This cam will generally put the meat of the powerband in the 2600-5800 RPM range. That means that for an exclusively drag-race-only application, you might want the converter to stall as high as 2600 RPM, and you would want to shift around 5800 RPM, if everything else is optimized for that RPM range. This cam runs great right off idle, as all real street cams should, and for applications involving street use, we recommend a more street-friendly stall speed for the converter.

Good ignition and exhaust recommended. Expect a hot-rod Idle. This cam is a good choice for truly streetable performance, as well as certain classes of gearbox-driven airboats.

[Read More](#)

Price: \$462.68 - \$1,495.00



VT20300 300H CAMSHAFT

SKU: VT20300

Hot Rods , Gearbox Airboats etc. OK Idle 2400-5500

Truly Streetable Performance

[Read More](#)

Price: \$447.32 - \$712.08



VT20275 275H CAMSHAFT

SKU: VT20275

Hot Rods, Gearbox Airboats, etc. Fair idle good choice for truly streetable performance. 2200-5400

Kit price includes lifters (usa) springs w/retainers, keepers ,locks & Viton seals

[Read More](#)

Price: \$447.32 - \$712.08



VT20250 250H CAMSHAFT

SKU: VT20250

Hot Rods , Cruisers, Gearbox Airboats 2200-5000 Hydraulic Flat tappet Cam

[Read More](#)

Price: \$447.32 - \$712.08



VT20205 205H CAMSHAFT "THE CRUISER"

SKU: VT20205

Restoration, Towing, Mild Hot Rods, Cruisers Good Idle 2000-4800

[Read More](#)

Price: \$447.32 - \$627.56



VT20120 120H CAMSHAFT

SKU: VT20120

Restoration, Towing, Good all around low rpm choice. 1800=4200

good idle

[Read More](#)

Price: \$447.32 - \$627.56



VT15151 ROLLER CAM THRUST BEARING

SKU: vt15151

Roller camshaft thrust bearing for roller cams with brass end ring for



reduced timing cover wear.

[Read More](#)

Price: \$75.00



VT13174 TRUE ROLLER TIMING CHAIN SET

SKU: VT13174

[Read More](#)

Price: \$190.00



VT13173 CLOYES STREET ROLLER TIMING SET

SKU: VT13173

[Read More](#)

Price: \$95.00



VT13172 OE SPEC TIMING SET

SKU: VT13172

with all-steel gears

[Read More](#)

Price: \$60.00



VT11022 425/368 STAINLESS TIMING COVER

SKU: VT11022

425/368 Stainless Steel Timing Cover

[Read More](#)

Price: \$95.00



VT11021 472/500 STAINLESS TIMING COVER

SKU: VT11021

472/500 Stainless Steel Timing Cover

[Read More](#)

Price: \$125.00



VT11011 472/500 TIMING COVER

SKU: VT11011

472/500 Timing Cover

[Read More](#)

Price: \$85.00

RB40111 CRANK KEY

SKU: RB40111

Crankshaft key for timing gear / crank hub for Cadillac 472 / 500 / 425 / 368 engines. The correct factory style key. Nothing special, just the right thing.

[Read More](#)

Price: \$6.00





OL21111 ISKY REV LUBE (VALVE TRAIN ASSEMBLY LUBE)

SKU: OL21111

Isky Rev Lube valve train assembly lube

[Read More](#)

Price: \$65.00



IG37032 COMPOSITE DISTRIBUTOR GEAR FOR MSD

SKU: IG37032

Composite Distributor Gear for MSD Pro Billet distributor

[Read More](#)

Price: \$138.95



IG37031 COMPOSITE DISTRIBUTOR GEAR FOR OE DISTRIBUTOR

SKU: IG37031

Composite Distributor Gear for OE Distributor

[Read More](#)

Price: \$138.95



IG37022 MELONIZED DISTRIBUTOR GEAR FOR MSD

SKU: IG37022

Melonized Distributor Gear for MSD Pro Billet distributor

[Read More](#)

Price: \$103.95



IG37021 MELONIZED DISTRIBUTOR GEAR FOR OE DISTRIBUTOR

SKU: IG37021

Melonized Distributor Gear for OE Distributor

[Read More](#)

Price: \$108.95



IG37012 BRONZE DISTRIBUTOR GEAR FOR MSD

SKU: IG37012

Bronze Distributor Gear for MSD Pro Billet distributor

[Read More](#)

Price: \$58.95



IG37011 BRONZE DISTRIBUTOR GEAR FOR OE DISTRIBUTOR

SKU: IG37011

Bronze Distributor Gear for OE distributor

[Read More](#)

Price: \$60.95



IG37002 IRON DISTRIBUTOR GEAR FOR MSD

SKU: IG37002

Iron Distributor Gear for MSD Pro Billet distributor

[Read More](#)

Price: \$62.78



GS41402 TIMING COVER GASKET FOR 472 / 500

SKU: GS41402

472 / 500 Cadillac Timing Cover Gasket

[Read More](#)

Price: \$10.00

CAMS & KITS

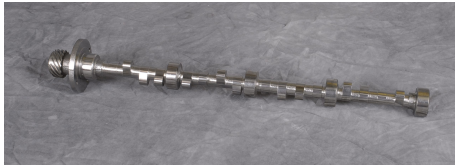

VT27011 ROLLER CAMS CUSTOM SOLID ROLLER KITS FROM \$2195

SKU: VT27011

CAM KIT

PER APPLICATION RPM

Custom Solid Roller Kits from \$2195

Call (505) 823-9340 for estimate on your vehicle's application

[Read More](#)

Price: \$2,195.00



VT26651 R 650 H RADICAL HYDRAULIC ROLLER: ROLLER VERSION OF THE PC650H KIT

SKU: VT26651

CAM KIT

3500-7000 RPM

Radical Hydraulic Roller: Roller version of the PC650H

[Read More](#)

Price: \$2,517.32



VT26650 R 650 H RADICAL HYDRAULIC ROLLER: ROLLER VERSION OF THE PC650H

SKU: VT26650

CAM ONLY

3500-7000 RPM

Radical Hydraulic Roller: Roller version of the PC650H

[Read More](#)

Price: \$1,077.31



VT26541 R 540 H BUDGET BRACKET RACING, STREET STOMPERS; OVAL TRACK @ 11:1 (STOCK, MODIFIED, IMCA) KIT

SKU: VT26541

CAM KIT

2800-6000 RPM

Budget Bracket Racing, Street Stompers; Oval Track @ 11:1 (Stock, Modified, IMCA)

[Read More](#)

Price: \$2,288.53



VT26540 R 540 H BUDGET BRACKET RACING, STREET STOMPERS; OVAL TRACK @ 11:1 (STOCK, MODIFIED, IMCA)

SKU: VT26540

CAM ONLY

2800-6000 RPM

Budget Bracket Racing, Street Stompers; Oval Track @ 11:1 (Stock, Modified, IMCA)

[Read More](#)

Price: \$979.38



VT26351 HIGH COMPRESSION (10:1 OR MORE) HOT-ROD STREET PERFORMANCE HYDRAULIC ROLLER CAM KIT R350H

SKU: VT26351

CAM KIT

2600-5800 RPM

High compression (10:1 or more) hot-rod street performance hydraulic roller cam.

Hot rods, gear box airboats, etc. Good ignition and exhaust recommended. OK Idle, Good choice for truly streetable performance. Cad Company hydraulic roller cams eliminate wear issues and are worth ~20-30 HP over the flat tappet version, with similar idle quality and RPM range.

[Read More](#)

Price: \$2,288.53



VT26350 R 350 H HIGH COMPRESSION (10:1 OR MORE) HOT-ROD STREET PERFORMANCE HYDRAULIC ROLLER CAM

SKU: VT26350

CAM ONLY

2600-5800 RPM

High compression (10:1 or more) hot-rod street performance hydraulic roller cam.

Hot rods, gear box airboats, etc. Good ignition and exhaust recommended. OK Idle, Good choice for truly streetable performance. Cad Company hydraulic roller cams eliminate wear issues and are worth ~20-30 HP over the flat tappet version, with similar idle quality and RPM range.

[Read More](#)

Price: \$979.38



VT26276R MILD STREET PERFORMANCE HYDRAULIC ROLLER CAM KIT R 275 H

SKU: VT26276

CAM KIT

2200-5200 RPM

Mild street performance hydraulic roller cam.

Hot rods, gear box airboats, etc. Fair Idle, Good choice for truly streetable performance.

Cad Company hydraulic roller cams eliminate wear issues and are worth ~20-30 HP over the flat tappet version, with similar idle quality and RPM range.

[Read More](#)

Price: \$2,288.53



VT26275 MILD STREET PERFORMANCE HYDRAULIC ROLLER CAM R 275 H

SKU: VT26275

CAM ONLY

2200-5200 RPM

Mild street performance hydraulic roller cam.
Hot rods, gear box airboats, etc. Fair Idle, Good choice for truly streetable performance.

Cad Company hydraulic roller cams eliminate wear issues and are worth ~20-30 HP over the flat tappet version, with similar idle quality and RPM range.

[Read More](#)

Price: \$979.38



VT26011 ROLLER CAMS CUSTOM HYDRAULIC ROLLER KITS FROM \$2288

SKU: VT26011

CAM KIT

PER APPLICATION RPM

Roller Cams Custom Hydraulic Roller Kits from \$2288

[Read More](#)

Price: \$2,288.53



VT25651 PRO/CAD 650 S OUR MOST POPULAR SOLID FLAT TAPPET RACE CAM KIT

SKU: VT25651

CAM KIT

3000-6500 RPM

Our most popular flat tappet solid race cam. For iron head non-roller combos, this cam is king of the hill.

[Read More](#)

Price: \$649.00



VT25650 PRO/CAD 650 S OUR MOST POPULAR SOLID FLAT TAPPET RACE CAM

SKU: VT25650

CAM ONLY

3000-6500 RPM

Our most popular flat tappet solid race cam. For iron head non-roller combos, this cam is king of the hill.

[Read More](#)

Price: \$415.00



VT25010 SOLID CAMS CUSTOM SOLID KITS FROM \$595

SKU: VT25010

CAM KIT

PER APPLICATION RPM

Solid Cams

Custom Solid Kits from \$595

[Read More](#)

Price: \$595.00



VT23651 PRO/CAD 650 H CAM KIT - RADICAL HYDRAULIC; THE BADDEST FLAT TAPPET HYDRAULIC YOU CAN GET

SKU: VT23651

CAM KIT

3500-6500 RPM

Radical Hydraulic: The baddest flat tappet hydraulic you can get

[Read More](#)

Price: \$830.16



VT23650 PRO/CAD 650 H CAMSHAFT - RADICAL HYDRAULIC; THE BADDEST FLAT TAPPET HYDRAULIC YOU CAN GET

SKU: VT23650

CAM ONLY

3500-6500 RPM

Radical Hydraulic: The baddest flat tappet hydraulic you can get

[Read More](#)

Price: \$493.27



VT23641 PRO/CAD 640 H CAM KIT - VERY STRONG HYDRAULIC; PRO/STREET STROKERS; BRACKET RACING; TRACTOR PULLS

SKU: VT23641

CAM KIT

3200-6800 RPM

Very strong hydraulic: PRO/Street Strokers; Bracket Racing; Tractor Pulls
KIT

[Read More](#)

Price: \$830.16



VT23640 PRO/CAD 640 H CAMSHAFT - VERY STRONG HYDRAULIC; PRO/STREET STROKERS; BRACKET RACING; TRACTOR PULLS

SKU: VT23640

CAM ONLY

3200-6800 RPM

Very strong hydraulic: PRO/Street Stokers; Bracket Racing; Tractor Pulls

[Read More](#)

Price: \$493.27



VT23626 PRO/CAD 625 H CAM KIT - VERY STRONG HYDRAULIC; PRO/STREET STROKERS; BRACKET RACING; TRACTOR PULLS

SKU: VT23626

CAM KIT

3200-6800 RPM

Very strong hydraulic: PRO/Street Stokers; Bracket Racing; Tractor Pulls

[Read More](#)

Price: \$813.89



VT23625 PRO/CAD 625 H CAMSHAFT - VERY STRONG HYDRAULIC; PRO/STREET STROKERS; BRACKET RACING; TRACTOR PULLS

SKU: VT23625

CAM ONLY

3200-6800 RPM

Very strong hydraulic: PRO/Street Stokers; Bracket Racing; Tractor Pulls

[Read More](#)

Price: \$477.68



VT23601 PRO/CAD 600 H CAM KIT - VERY STRONG HYDRAULIC; PRO/STREET; BRACKET RACING; ASPHALT OVAL TRACK

SKU: VT23601

CAM KIT

3000-6500 RPM

Very strong hydraulic: PRO/Street; Bracket Racing; Asphalt Oval Track

[Read More](#)

Price: \$813.89



VT23600 PRO/CAD 600 H CAMSHAFT - VERY STRONG HYDRAULIC; PRO/STREET; BRACKET RACING; ASPHALT OVAL TRACK

SKU: VT23600

CAM ONLY

3000-6500 RPM

Very strong hydraulic: PRO/Street; Bracket Racing; Asphalt Oval Track

[Read More](#)

Price: \$477.68



VT23541 PRO/CAD 540 H CAM KIT - BUDGET BRACKET RACING, STREET STOMPERS; OVAL TRACK @ 11:1 (STOCK, MODIFIED, IMCA)

SKU: VT23541

CAM KIT

2600-5800 RPM

Budget Bracket Racing, Street Stompers; Oval Track @ 11:1 (Stock, Modified, IMCA)

[Read More](#)

Price: \$813.89



VT23540 PRO/CAD 540 H CAMSHAFT - BUDGET BRACKET RACING, STREET STOMPERS; OVAL TRACK @ 11:1 (STOCK, MODIFIED, IMCA)

SKU: VT23540

CAM ONLY

2800-6000 RPM

Budget Bracket Racing, Street Stompers; Oval Track @ 11:1 (Stock, Modified, IMCA)

[Read More](#)

Price: \$477.68



VT23206 PRO/CAD 205 H CAM KIT - CRUISER / BUDGET HOT ROD

SKU: VT23206

CAM KIT

2000-4200 RPM

Cruiser / budget hot rod cam

Mild Hot Rods, Cruisers. Mild cam with hot rod idle. More power than the SS205H, in the same RPM range, and safe with Stage 1 rockers.

This cam is ideal for making absolute maximum torque you can get at 3000 RPM.

[Read More](#)

Price: \$642.92



VT23205 PRO/CAD 205 H CAMSHAFT - CRUISER / BUDGET HOT ROD

SKU: VT23205

CAM ONLY

2000-4200 RPM

Cruiser / budget hot rod cam

Mild Hot Rods, Cruisers. Mild cam with hot rod idle. More power than the SS205H, in the same RPM range, and safe with Stage 1 rockers.

This cam is ideal for making absolute maximum torque you can get at 3000 RPM.

[Read More](#)

Price: \$462.68



VT23121 PRO/CAD 120 H CAM KIT - MILD HOT ROD / DIRECT DRIVE AIRBOAT

SKU: VT23121

PC120H CAM KIT

1500-4200 RPM

This cam is ideal for making the absolute maximum torque you can get at 3000 RPM.

The best lopey-idle cam for an other wise stock engine, stock rockers are generally reliable with this cam (assuming they're in good condition).

[Read More](#)

Price: \$642.92



VT23120 PRO/CAD 120 H CAMSHAFT

SKU: VT23120

CAM ONLY

1500-4200 RPM

This cam is ideal for making the absolute maximum torque you can get at 3000 RPM.

The best lopey-idle cam for an other wise stock engine, stock rockers are generally reliable with this cam (assuming they're in good condition).

[Read More](#)

Price: \$462.68



VT22301 SS 300 H CAM KIT - HIGH COMPRESSION (10:1 OR MORE) HOT-ROD STREET PERFORMANCE

SKU: VT22301

CAM KIT

2400-5500 RPM

High compression (10:1 or more) hot-rod street performance cam.

Hot rods, gear box airboats, etc. Good ignition and exhaust recommended. OK Idle, Good choice for truly streetable performance.

[Read More](#)

Price: \$712.08



VT22300 SS 300 H HIGH COMPRESSION (10:1 OR MORE) HOT-ROD STREET PERFORMANCE CAM SS 300 H

SKU: VT22300

CAM ONLY

2400-5500 RPM

High compression (10:1 or more) hot-rod street performance cam. Hot rods, gear box airboats, etc. Good ignition and exhaust recommended. OK Idle, Good choice for truly streetable performance.

[Read More](#)

Price: \$447.32



VT22276 SS 275 H CAM KIT - HIGH COMPRESSION (10:1 OR MORE) MILD STREET PERFORMANCE

SKU: VT22276

CAM KIT

2200-5200 RPM

High compression (10:1 or more) mild street performance cam. Hot rods, gear box airboats, etc. Fair Idle, Good choice for truly streetable performance.

[Read More](#)

Price: \$712.08



VT22275 SS 275 H CAMSHAFT - HIGH COMPRESSION (10:1 OR MORE) MILD STREET PERFORMANCE

SKU: VT22275

CAM ONLY

2200-5200 RPM

High compression (10:1 or more) mild street performance cam. Hot rods, gear box airboats, etc. Fair Idle, Good choice for truly streetable performance.

[Read More](#)

Price: \$447.32



VT22251 SS 250 H CAM KIT - HIGH COMPRESSION (10:1 OR MORE) MILD STREET PERFORMANCE

SKU: VT22251

CAM KIT

2200-5000 RPM

High compression (10:1 or more) mild street performance cam
Hot rods, gear box airboats, etc. Fair Idle, Good choice for truly streetable performance.

[Read More](#)

Price: \$712.08



VT22250 SS 250 H CAMSHAFT - HIGH COMPRESSION (10:1 OR MORE) MILD STREET PERFORMANCE

SKU: VT22250

CAM ONLY

2200-5000 RPM

High compression (10:1 or more) mild street performance cam
Hot rods, gear box airboats, etc. Fair Idle, Good choice for truly streetable performance.

[Read More](#)

Price: \$447.32



VT22206 SS 205 H CAM KIT - HIGH COMPRESSION (10:1 OR MORE)

SKU: VT22206

SS205H CAM KIT

2000-4200 RPM

High compression (10:1 or more) RV cam.
Restoration, Towing, Mild Hot Rods, Cruisers. Good Idle.

[Read More](#)

Price: \$627.56



VT22205 SS 205 H CAMSHAFT - HIGH COMPRESSION (10:1 OR MORE)

SKU: VT22205

SS205H CAM ONLY

2000-4200 RPM

High compression (10:1 or more) RV cam.
Restoration, Towing, Mild Hot Rods, Cruisers. Good Idle.

[Read More](#)

Price: \$447.32



VT22121 SS 120 H CAM KIT - HIGH COMPRESSION (10:1 OR MORE)

SKU: VT22121

CAM KIT

1800-4200 RPM

High compression (10:1 or more) RV cam.
Restoration, Towing, Direct Drive Airboat. Near stock idle quality, Best all around choice for low RPM applications.
Note: This cam is designed to idle well as low as 450 RPM, for those that need that feature.

Kit Pricing is for the Camshaft, as well as appropriate lifters, springs, retainers, locks, and valve stem seals. Cams generally come with a complimentary single-serving-size cam lube as available.

[Read More](#)

Price: \$627.56



VT22120 SS 120 H CAMSHAFT HIGH COMPRESSION (10:1 OR MORE) RV

SKU: VT22120

CAM ONLY

1800-4200 RPM

High compression (10:1 or more) RV cam.
Restoration, Towing, Direct Drive Airboat. Near stock idle quality, Best all around choice for low RPM applications.
Note: This cam is designed to idle well as low as 450 RPM, for those that need that feature.

[Read More](#)

Price: \$447.32



VT21301 CTA 300 H CAM KIT - LOW COMPRESSION (9.2:1 OR LESS) HOT-ROD STREET PERFORMANCE

SKU: VT21301

CAM KIT

2400-5500 RPM

Low compression (9.2:1 or less) hot-rod street performance cam. Hot rods, gear box airboats, etc. Good ignition and exhaust recommended. OK Idle, Good choice for truly streetable performance.

[Read More](#)

Price: \$712.08



VT21300 CTA 300 H CAMSHAFT - LOW COMPRESSION (9.2:1 OR LESS) HOT-ROD STREET PERFORMANCE

SKU: VT21300

CAM ONLY

2400-5500 RPM

Low compression (9.2:1 or less) hot-rod street performance cam. Hot rods, gear box airboats, etc. Good ignition and exhaust recommended. OK Idle, Good choice for truly streetable performance.

[Read More](#)

Price: \$462.68



VT21276 CTA 275 H CAM KIT - LOW COMPRESSION (9.2:1 OR LESS) MILD STREET PERFORMANCE

SKU: VT21276

CAM KIT

2200-5200 RPM

Low compression (9.2:1 or less) mild street performance cam. Hot rods, gear box airboats, etc. Fair Idle, Good choice for truly streetable performance.

[Read More](#)

Price: \$712.08



VT21275 CTA 275 H CAMSHAFT - LOW COMPRESSION (9.2:1 OR LESS) MILD STREET PERFORMANCE

SKU: VT21275

CAM ONLY

2200-5200 RPM

Low compression (9.2:1 or less) mild street performance cam. Hot rods, gear box airboats, etc. Fair Idle, Good choice for truly streetable performance.

[Read More](#)

Price: \$462.68



VT21251 CTA 250 H CAM KIT - LOW COMPRESSION (9.2:1 OR LESS) MILD STREET PERFORMANCE

SKU: VT21251

CAM KIT

2200-5000 RPM

Low compression (9.2:1 or less) mild street performance cam. Hot rods, gear box airboats, etc. Fair Idle, Good choice for truly streetable performance.

[Read More](#)

Price: \$712.08



VT21250 CTA 250 H CAMSHAFT - LOW COMPRESSION (9.2:1 OR LESS) MILD STREET PERFORMANCE

SKU: VT21250

CAM ONLY

2200-5000 RPM

Low compression (9.2:1 or less) mild street performance cam. Hot rods, gear box airboats, etc. Fair Idle, Good choice for truly steerable performance.

[Read More](#)

Price: \$462.68



VT21206 CTA 205 H CAM KIT - LOW COMPRESSION (9.2:1 OR LESS)

SKU: VT21206

CAM KIT

2000-4200 RPM

Low compression (9.2:1 or less) RV cam.
Restoration, Towing, Mild Hot Rods, Cruisers. Good Idle.

[Read More](#)

Price: \$627.56



VT21205 CTA 205 H CAMSHAFT - LOW COMPRESSION (9.2:1 OR LESS)

SKU: VT21205

CAM ONLY

2000-4200 RPM

Low compression (9.2:1 or less) RV cam.
Restoration, Towing, Mild Hot Rods, Cruisers. Good Idle.

[Read More](#)

Price: \$447.32



VT21121 CTA 120 H CAM KIT - LOW COMPRESSION (9.2:1 OR LESS)

SKU: VT21121

CAM KIT

1800-4200 RPM

Low compression (9.2:1 or less) RV cam.
Restoration, Towing, Direct Drive Airboat. Near stock idle quality, Best all around choice for low RPM applications.
Note: This cam is designed to idle well as low as 450 RPM, for those that need that feature.

Kit Pricing is for the Camshaft, as well as appropriate lifters, springs, retainers, locks, and valve stem seals. Cams generally come with a complimentary single-serving-size cam lube as available.

[Read More](#)

Price: \$627.56



VT21120 CTA 120 H CAMSHAFT - LOW COMPRESSION (9.2:1 OR LESS)

SKU: VT21120

CAM ONLY

1800-4200 RPM

Low compression (9.2:1 or less) RV cam.

Restoration, Towing, Direct Drive Airboat. Near stock idle quality, Best all around choice for low RPM applications.

Note: This cam is designed to idle well as low as 450 RPM, for those that need that feature.

[Read More](#)

Price: \$447.32



VT20350 SS 350 H CAMSHAFTS AND KITS - HIGH COMPRESSION (10:1 OR MORE) HOT-ROD STREET PERFORMANCE

SKU: VT20350

350 H series camshaft

This cam will generally put the meat of the powerband in the 2600-5800 RPM range. That means that for an exclusively drag-race-only application, you might want the converter to stall as high as 2600 RPM, and you would want to shift around 5800 RPM, if everything else is optimized for that RPM range. This cam runs great right off idle, as all real street cams should, and for applications involving street use, we recommend a more street-friendly stall speed for the converter.

Good ignition and exhaust recommended. Expect a hot-rod Idle. This cam is a good choice for truly streetable performance, as well as certain classes of gearbox-driven airboats.

[Read More](#)

Price: \$462.68 - \$1,495.00



VT20300 300H CAMSHAFT

SKU: VT20300

Hot Rods , Gearbox Airboats etc. OK Idle 2400-5500

Truly Streetable Performance

[Read More](#)

Price: \$447.32 - \$712.08



VT20275 275H CAMSHAFT

SKU: VT20275

Hot Rods, Gearbox Airboats, etc. Fair idle good choice for truly streetable performance. 2200-5400

Kit price includes lifters (usa) springs w/retainers, keepers ,locks & Viton seals

[Read More](#)

Price: \$447.32 - \$712.08



VT20250 250H CAMSHAFT

SKU: VT20250

Hot Rods , Cruisers, Gearbox Airboats 2200-5000 Hydraulic Flat tappet Cam

[Read More](#)

Price: \$447.32 - \$712.08



VT20205 205H CAMSHAFT "THE CRUISER"

SKU: VT20205

Restoration, Towing, Mild Hot Rods, Cruisers Good Idle 2000-4800

[Read More](#)

Price: \$447.32 - \$627.56



VT20120 120H CAMSHAFT

SKU: VT20120

Restoration, Towing, Good all around low rpm choice. 1800=4200

good idle

[Read More](#)

Price: \$447.32 - \$627.56

VT15151 ROLLER CAM THRUST BEARING

SKU: vt15151

Roller camshaft thrust bearing for roller cams with brass end ring for



**MADE IN
THE U.S.A.**

reduced timing cover wear.

[Read More](#)

Price: \$75.00



LIFTERS



VT31112 LIFTERS - FLAT TAPPET HYDRAULIC FOR 472, 500, 425, 368, AND '67 429

SKU: VT31112

Flat Tappet Hydraulic Lifters - nothing special, just good quality and correct fit. Set of 16

Made in the USA

[Read More](#)

Price: \$175.00



NEW REPLACEMENT TIMING COVERS

These high quality covers are stamped from a single sheet of steel, with integrated lip to support the crank seal and welded oil pan seal lip, to fit and work like the originals. The stainless steel variations are marine grade stainless steel for superior looks and longer life.

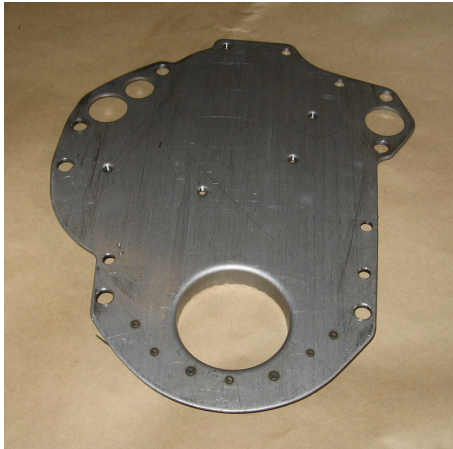

VT11022 425/368 STAINLESS TIMING COVER

SKU: VT11022

425/368 Stainless Steel Timing Cover

[Read More](#)

Price: \$95.00



VT11021 472/500 STAINLESS TIMING COVER

SKU: VT11021

472/500 Stainless Steel Timing Cover

[Read More](#)

Price: \$125.00



VT11011 472/500 TIMING COVER

SKU: VT11011

472/500 Timing Cover

[Read More](#)

Price: \$85.00



GS41402 TIMING COVER GASKET FOR 472 / 500

SKU: GS41402

472 / 500 Cadillac Timing Cover Gasket

[Read More](#)

Price: \$10.00

ROCKER SYSTEMS



VT75113 OVER-LENGTH OE REPLACEMENT PUSHRODS CUSTOM ONLY

SKU: VT75113

Available in +.030"

[Read More](#)

Price: \$276.00

VT75112 HD STOCK REPLACEMENT PUSHROD (SET OF 16)

SKU: VT75112

HD Stock Replacement Pushrod (set of 16)

Heavy Duty thick wall Chromoly.

Stock length (10.200") Fits '68-'85 472 / 500 / 425 / 368 engines except 4-6-8 with OEM or newer Stage 3 rockers.

Made in USA

[Read More](#)

Price: \$295.00





VT75111 OE REPLACEMENT PUSHRODS (SET OF 16)

SKU: VT75111

OE Replacement Pushrods OE or Stage III A Rockers (set of 16)

[Read More](#)

Price: \$75.00



VT75102 HD STOCK REPLACEMENT PUSHROD (SINGLE)

SKU: VT75102

HD Stock Replacement Pushrod (single)

Heavy Duty thick wall Chromoly.

Stock length (10.200") Fits '68-'85 472 / 500 / 425 / 368 engines except 4-6-8 with OEM or newer Stage 3 rockers.

Made in USA

[Read More](#)

Price: \$15.00



VT75011 CUSTOM CHROMOLY PUSHRODS

SKU: VT75011

any size \$175 and up

[Read More](#)

Price: \$225.00



VT75001 ADJUSTABLE PUSHROD

SKU: VT75001

Full credit towards custom pushrods upon return.

[Read More](#)

Price: \$35.00



VT73104 RETAINING CLIPS (MOUSE TRAPS)

SKU: yVT73104

4 per engine. note: good used OEM clips

[Read More](#)

Price: \$20.00



VT73103 EXHAUST ROCKERS 1.65:1

SKU: VT73103

8 per engine, new

[Read More](#)

Price: \$30.00



VT73102 INTAKE ROCKERS 1.65:1

SKU: VT73102

8 per engine, new

[Read More](#)

Price: \$30.00



VT73101 T-PEDESTALS - AFTERMARKET

SKU: VT73101

8 per engine, new

Aftermarket pedestals, tougher than stock for increased reliability.

[Read More](#)

Price: \$30.00



VT71770 BOOGIEMAN PRO COMP ROLLER ROCKERS

SKU: VT71770

PRO COMP ROLLER ROCKERS



MADE IN THE U.S.A.

MADE IN THE U.S.A.

Adjustable Full Shaft Roller Rockers

Premium roller rocker setup for solid cams. Roller tip shaft rockers, with roller trunnions, individually adjustable, with a full girdle, suitable for builds at all levels of performance with a solid cam. For BoogieMan heads.

[Read More](#)

Price: \$2,087.40



**MADE IN
THE U.S.A.**

VT71730 PRO COMP ROLLER ROCKERS

SKU: VT71730

PRO COMP ROLLER ROCKERS



**MADE IN
THE U.S.A.**

Adjustable Full Shaft Roller Rockers

Premium roller rocker setup for solid cams. Roller tip shaft rockers, with roller trunnions, individually adjustable, with a full girdle, suitable for builds at all levels of performance with a solid cam. For iron or Bulldog / FR aluminum heads.

[Read More](#)

Price: \$1,491.16

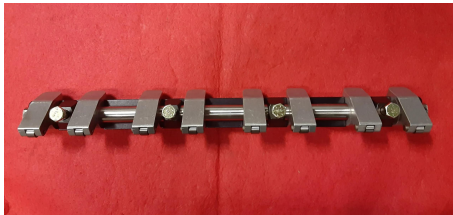

VT71710 PRO STREET ROLLER ROCKERS

SKU: VT71710

PRO STREET ROLLER ROCKERS



**MADE IN
THE U.S.A.**

Non-Adjustable Full Shaft Roller Rockers

Premium roller rocker setup for hydraulic cams. Roller tip shaft rockers, non-adjustable, with a full girdle, suitable for builds at all levels of performance without a solid cam. For iron or Bulldog / FR aluminum heads.

[Read More](#)

Price: \$1,182.50



**MADE IN
THE U.S.A.**

VT71440 STAGE IV SS (1.73:1) ADJUSTABLE ROLLER TIP SHAFT ROCKER ASSEMBLY

SKU: VT71440

Stage IV SS (1.73:1) Adjustable Roller Tip Shaft Rocker Assembly with Stainless Steel rocker arms.

[Read More](#)

Price: \$1,695.00



VT71420 STAGE IV (1.73:1) ADJUSTABLE ROLLER TIP SHAFT ROCKER ASSEMBLY

SKU: VT71420

Stage IV (1.73:1) Adjustable Roller Tip Shaft Rocker Assembly

[Read More](#)

Price: \$1,523.82



VT71310 STAGE III (1.72:1) SHAFT ROCKER ASSEMBLY USES STOCK PUSHRODS

SKU: VT71310

Stage III (1.72:1) Shaft Rocker Assembly uses stock pushrods

[Read More](#)

Price: \$973.84



505-823-9340
8333 JEFFERSON NE
ALBUQUERQUE, NM 87113
CADILLACPERFORMANCE.COM

VT71101 OEM ROCKER COMPONENTS FULL SET

SKU: VT71101

Complete set of 8 new intake rockers, 8 new exhaust rockers, 8 new T-Pedestals, and 4 good original sheet metal retaining clips.

[Read More](#)

Price: \$425.00



Originators of 8.2 Liter Performance

TM

FULL SHAFT ROCKER ASSEMBLIES



**MADE IN
THE U.S.A.**

VT71770 BOOGIEMAN PRO COMP ROLLER ROCKERS

SKU: VT71770

PRO COMP ROLLER ROCKERS



**MADE IN
THE U.S.A.**

Adjustable Full Shaft Roller Rockers

Premium roller rocker setup for solid cams. Roller tip shaft rockers, with roller trunnions, individually adjustable, with a full girdle, suitable for builds at all levels of performance with a solid cam. For BoogieMan heads.

[Read More](#)

Price: \$2,087.40



**MADE IN
THE U.S.A.**

VT71730 PRO COMP ROLLER ROCKERS

SKU: VT71730

PRO COMP ROLLER ROCKERS



**MADE IN
THE U.S.A.**

Adjustable Full Shaft Roller Rockers

Premium roller rocker setup for solid cams. Roller tip shaft rockers, with roller trunnions, individually adjustable, with a full girdle, suitable for builds at all levels of performance with a solid cam. For iron or Bulldog / FR aluminum heads.

[Read More](#)

Price: \$1,491.16

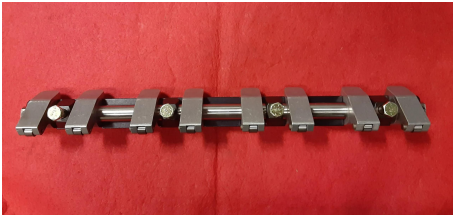

VT71710 PRO STREET ROLLER ROCKERS

SKU: VT71710

PRO STREET ROLLER ROCKERS



Non-Adjustable Full Shaft Roller Rockers

Premium roller rocker setup for hydraulic cams. Roller tip shaft rockers, non-adjustable, with a full girdle, suitable for builds at all levels of performance without a solid cam. For iron or Bulldog / FR aluminum heads.

[Read More](#)

Price: \$1,182.50



VT71440 STAGE IV SS (1.73:1) ADJUSTABLE ROLLER TIP SHAFT ROCKER ASSEMBLY

SKU: VT71440

Stage IV SS (1.73:1) Adjustable Roller Tip Shaft Rocker Assembly with Stainless Steel rocker arms.

[Read More](#)

Price: \$1,695.00

**MADE IN
THE U.S.A.**



VT71420 STAGE IV (1.73:1) ADJUSTABLE ROLLER TIP SHAFT ROCKER ASSEMBLY

SKU: VT71420

Stage IV (1.73:1) Adjustable Roller Tip Shaft Rocker Assembly

[Read More](#)

Price: \$1,523.82



VT71310 STAGE III (1.72:1) SHAFT ROCKER ASSEMBLY USES STOCK PUSHRODS

SKU: VT71310

Stage III (1.72:1) Shaft Rocker Assembly uses stock pushrods

[Read More](#)

Price: \$973.84

OEM STYLE (T-PEDESTAL) ROCKER COMPONENTS



VT73104 RETAINING CLIPS (MOUSE TRAPS)

SKU: yVT73104

4 per engine. note: good used OEM clips

[Read More](#)

Price: \$20.00



VT73103 EXHAUST ROCKERS 1.65:1

SKU: VT73103

8 per engine, new

[Read More](#)

Price: \$30.00





VT73102 INTAKE ROCKERS 1.65:1

SKU: VT73102

8 per engine, new

[Read More](#)

Price: \$30.00



VT73101 T-PEDESTALS - AFTERMARKET

SKU: VT73101

8 per engine, new

Aftermarket pedestals, tougher than stock for increased reliability.

[Read More](#)

Price: \$30.00

VT71101 OEM ROCKER COMPONENTS FULL SET

SKU: VT71101

Complete set of 8 new intake rockers, 8 new exhaust rockers, 8 new T-Pedestals, and 4 good original sheet metal retaining clips.

[Read More](#)

Price: \$425.00



PUSHRODS



VT75113 OVER-LENGTH OE REPLACEMENT PUSHRODS CUSTOM ONLY

SKU: VT75113

Available in +.030"

[Read More](#)

Price: \$276.00

VT75112 HD STOCK REPLACEMENT PUSHROD (SET OF 16)

SKU: VT75112

HD Stock Replacement Pushrod (set of 16)

Heavy Duty thick wall Chromoly.

Stock length (10.200") Fits '68-'85 472 / 500 / 425 / 368 engines except 4-6-8 with OEM or newer Stage 3 rockers.

Made in USA

[Read More](#)

Price: \$295.00





VT75111 OE REPLACEMENT PUSHRODS (SET OF 16)

SKU: VT75111

OE Replacement Pushrods OE or Stage III A Rockers (set of 16)

[Read More](#)

Price: \$75.00



VT75102 HD STOCK REPLACEMENT PUSHROD (SINGLE)

SKU: VT75102

HD Stock Replacement Pushrod (single)

Heavy Duty thick wall Chromoly.

Stock length (10.200") Fits '68-'85 472 / 500 / 425 / 368 engines except 4-6-8 with OEM or newer Stage 3 rockers.

Made in USA

[Read More](#)

Price: \$15.00



VT75011 CUSTOM CHROMOLY PUSHRODS

SKU: VT75011

any size \$175 and up

[Read More](#)

Price: \$225.00

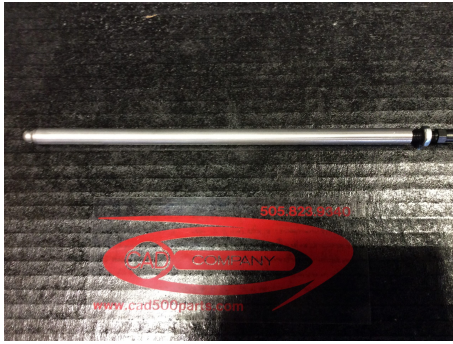

VT75001 ADJUSTABLE PUSHROD

SKU: VT75001

Full credit towards custom pushrods upon return.

[Read More](#)

Price: \$35.00

TIMING



VT15151 ROLLER CAM THRUST BEARING

SKU: vt15151

Roller camshaft thrust bearing for roller cams with brass end ring for

reduced timing cover wear.

[Read More](#)

Price: \$75.00



**MADE IN
THE U.S.A.**



VT13174 TRUE ROLLER TIMING CHAIN SET

SKU: VT13174

[Read More](#)

Price: \$190.00





VT13173 CLOYES STREET ROLLER TIMING SET

SKU: VT13173

[Read More](#)

Price: \$95.00



VT13172 OE SPEC TIMING SET

SKU: VT13172

with all-steel gears

[Read More](#)

Price: \$60.00



VT11022 425/368 STAINLESS TIMING COVER

SKU: VT11022

425/368 Stainless Steel Timing Cover

[Read More](#)

Price: \$95.00

RB40111 CRANK KEY

SKU: RB40111

Crankshaft key for timing gear / crank hub for Cadillac 472 / 500 / 425 / 368 engines. The correct factory style key. Nothing special, just the right thing.

[Read More](#)

Price: \$6.00



OL21111 ISKY REV LUBE (VALVE TRAIN ASSEMBLY LUBE)

SKU: OL21111

Isky Rev Lube valve train assembly lube

[Read More](#)

Price: \$65.00



VALVE SPRING KITS



VT33114 VALVE SPRING KITS STAGE 4

SKU: VT33114

Oversized HD dual performance springs
Up to .720 lift.

[Read More](#)

Price: \$250.00



VT33113 VALVE SPRING KITS STAGE 3

SKU: VT33113

Small diameter high performance springs
Up to .600 lift.

[Read More](#)

Price: \$250.00





VT33112 VALVE SPRING KITS STAGE 2

SKU: VT33112

Oversized high performance springs
Up to .600 lift.

[Read More](#)

Price: \$150.00



VT33111 VALVE SPRING KITS STAGE 1

SKU: VT33111

OE size performance springs
Up to .550 lift.

[Read More](#)

Price: \$105.00

VALVE STEM SEALS

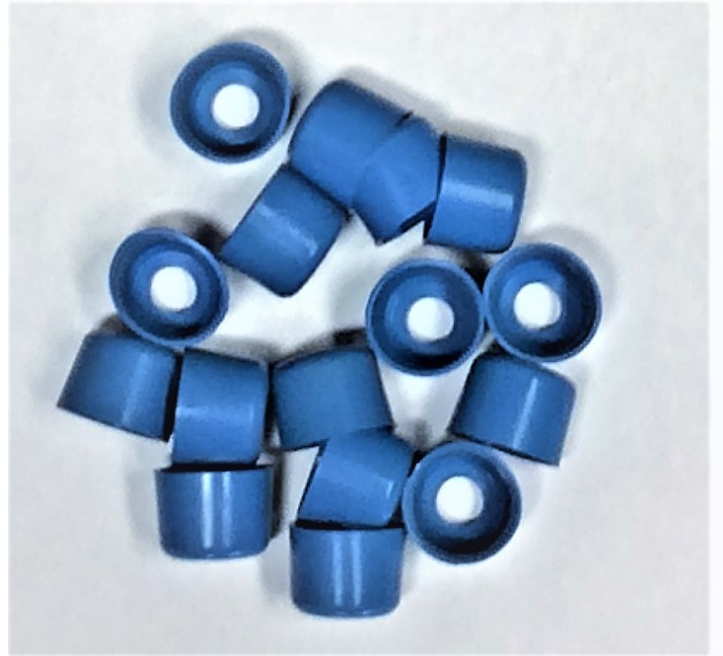

VT37012 VITON UMBRELLA VALVE STEM SEALS

SKU: VT37012

Viton Umbrella Valve Stem Seals

[Read More](#)

Price: \$20.00

VALVE STEM SEALS

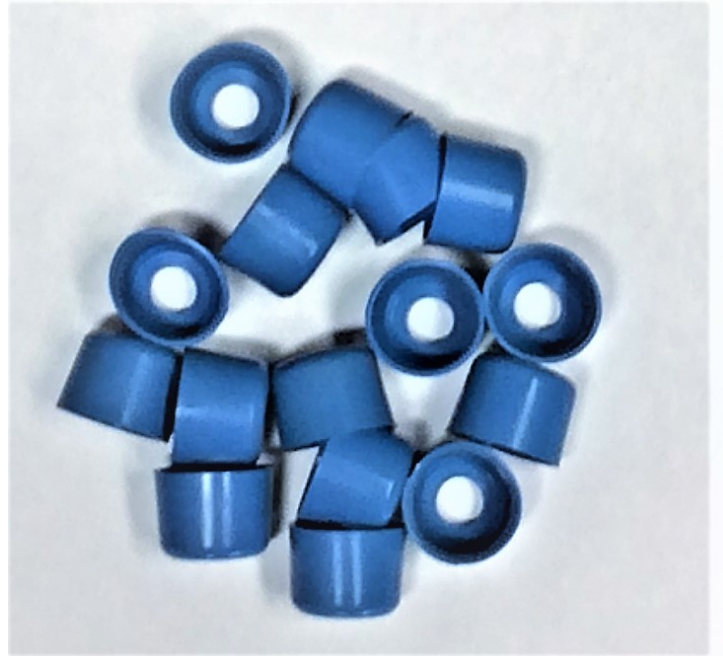

VT37012 VITON UMBRELLA VALVE STEM SEALS

SKU: VT37012

Viton Umbrella Valve Stem Seals

[Read More](#)

Price: \$20.00

VALVES

Swirl-polished oversize Stainless valves are available in full sets of (16) for all heads, 1968 through 1979. They are ready to install with 11/32" stems, and any competent machine shop in your area can machine the oversize hardened seats unless you are repairing a damaged head, nor do we recommend reusing stock valves. With the high nickel content of the Caddy heads, and stainless valves (which are very difficult to damage), you should be able to get many, many miles of trouble free operation from your upgraded heads, even on unleaded fuels.



VT53702 120CC (472 / 500) AND 425 2.19 / 1.85 STAINLESS VALVES

SKU: VT53702

120cc and 425 2.19 / 1.85 SS Valves

For ported heads.

[Read More](#)

Price: \$325.00



VT53701 120CC (472 / 500) AND 425 2.11 / 1.77 STAINLESS VALVES

SKU: VT53701

120cc and 425 2.11 / 1.77 SS Valves

For ported heads.

[Read More](#)

Price: ~~\$295.00~~ \$275.00



VT53301 120CC (472 / 500) AND 425 REPLACEMENT VALVES

SKU: VT53301

120cc Stock Size Valves

for unleaded fuel.

[Read More](#)

Price: \$195.00



VT51702 76CC 2.25 / 1.90 STAINLESS VALVES

SKU: VT51702

76cc 2.25 / 1.90 SS Valves

For high-end applications that call for full-port heads.

[Read More](#)

Price: \$350.00



VT51701 76CC 2.19 / 1.90 STAINLESS VALVES

SKU: VT51701

76cc 2.19 / 1.90 SS Valves

For ported heads.

[Read More](#)

Price: \$325.00



VT51301 76CC REPLACEMENT VALVES

SKU: VT51301

76cc Stock Size Valves

for unleaded fuel.

[Read More](#)

Price: \$195.00



WIRING AND SWITCHES

Wiring, switches, sensors, and other electrical bits and bobs.



WS66103 ALTERNATOR WIRING CONVERSION KIT

SKU: WS66103

Alternator Wiring Conversion Kit

Plug-and-play kit for wiring a 3-wire (stock '73-up GM) internally regulated alternator, into vehicles original equipped with an externally regulated GM alternator (such as '62-'72 Cadillacs). Includes adapter plug for alternator and external-regulator-elimination-plug for the connector that used to plug into the external regulator.

[Read More](#)

Price: \$45.00

WS51204 HEI POWER / TACH PIGTAILS

SKU: WS51204

Original GM parts with 8"+ wire pigtails.

[Read More](#)

Price: \$45.00



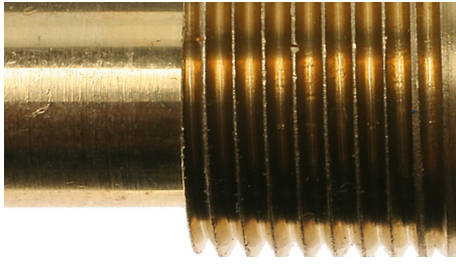

WS21101 COOLANT TEMPERATURE SWITCH

SKU: WS21101

Coolant temperature switch for warning light.

For carbureted Cadillac 472 / 500 / 425 / 368 engines.

1 per engine.

[Read More](#)

Price: \$55.63

CORE PARTS

Core parts are subject to availability. We are not a junkyard, and only offer these items as we have them available through the normal course of tearing down engine cores for our complete engine customers.

For new replacement parts, please see the appropriate product categories in the main catalog.

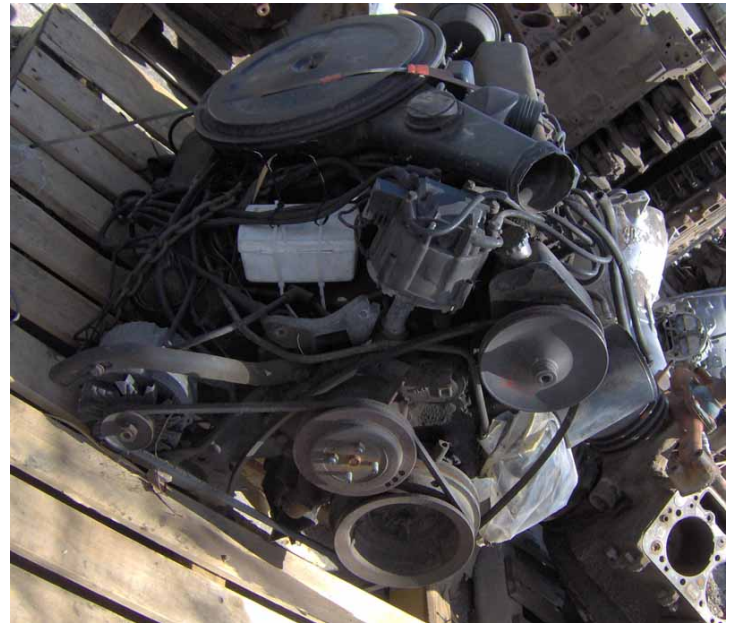

PB64111 ALTERNATOR BRACKET SET (W/ AIR PUMP MOUNTING PROVISION)

SKU: yPB64111

Alternator Bracket Set w/ AIR pump mounting provision

[Read More](#)

Price: \$65.00



PB64110 ALTERNATOR BRACKET SET (W/O AIR PUMP MOUNTING PROVISION)

SKU: yPB64110

Alternator Bracket Set Without AIR pump mounting provision

[Read More](#)

Price: \$105.00

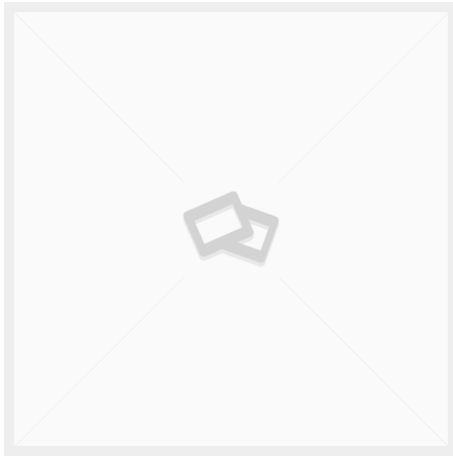

PB53001 - OE POWER STEERING BRACKET

SKU: yPB53001

OE Power Steering Bracket

[Read More](#)

Price: \$195.00

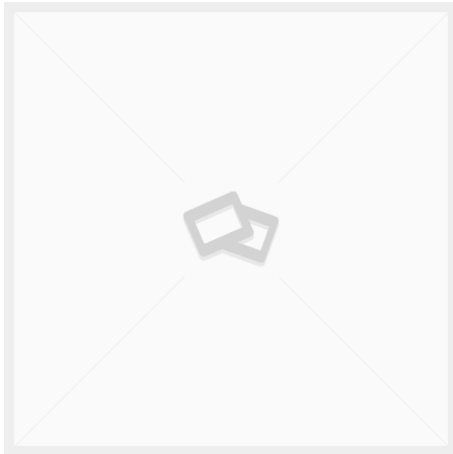

PB35112 - OE '77-'79 425 AC BRACKET SET

SKU: yPB35112

'77-'79 425 AC Bracket Set 2 pieces, for A6 compressor

[Read More](#)

Price: \$150.00

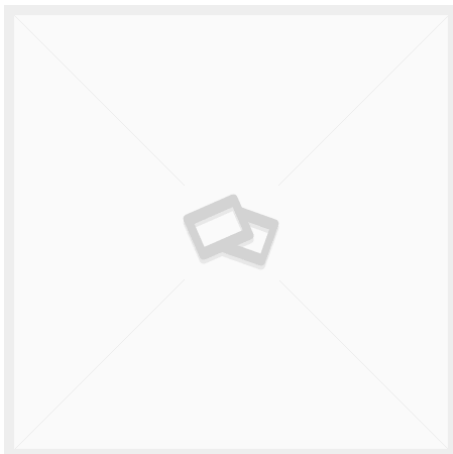

PB35111 '68-'76 472 / 500 AC BRACKET SET

SKU: yPB35111

'68-'76 472 / 500 AC Bracket Set

[Read More](#)

Price: \$150.00

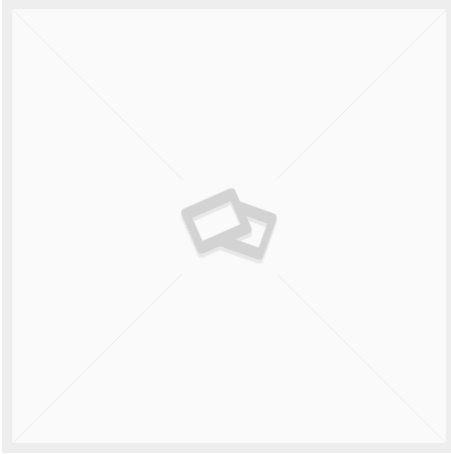

PB34110 '80-'85 AC BRACKET SET 2 PCS. - R4 COMPRESSOR

SKU: yPB34110

'80-'85 AC Bracket Set 2 pieces, for R4 compressor

[Read More](#)

Price: \$180.00



PB18032 BILLET ALUMINUM CRANK AND WATER PUMP PULLEY SET, 2-GROOVE PS / AC, WITH SMOG ('68/'69 AND '71-'73 STYLE)

SKU: PB18032

3 groove crank, 2 groove WP

[Read More](#)

Price: \$600.00



PB18021 BILLET ALUMINUM CRANK AND WATER PUMP PULLEY SET, NON-SMOG (1974-UP STYLE)

SKU: PB18021

2 groove crank, 1 groove WP

[Read More](#)

Price: \$599.00

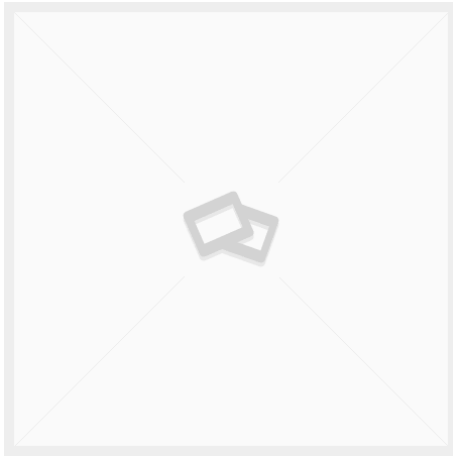

PB11101 - OE CRANK HUB

SKU: yPB11101

Original crankshaft hub

[Read More](#)

Price: \$95.00



OS11151 '80-'85 REAR SUMP OIL PAN ELDORADO 1 DRAIN PLUG

SKU: yOS11151

Oil Pans

All oil pans are vatted, and checked for defects that would cause them to be unusable, such as excessive rust on sealing surfaces, cracks, holes, and severe warpage.

[Read More](#)

Price: \$250.00



OS11132 '77-'78 REAR SUMP OIL PAN ELDORADO - 1 DRAIN PLUG

SKU: yOS11132

Oil Pans

All oil pans are vatted, and checked for defects that would cause them to be unusable, such as excessive rust on sealing surfaces, cracks, holes, and severe warpage.

[Read More](#)

Price: \$250.00



OS11131 '68-'76 REAR SUMP OIL PAN ELDORADO (2 DRAIN PLUGS)

SKU: yOS11131

Oil Pans

All oil pans are vatted, and checked for defects that would cause them to be unusable, such as excessive rust on sealing surfaces, cracks, holes, and severe warpage.

[Read More](#)

Price: \$250.00



OS11121 '77-'85 MID SUMP OIL PAN ALL EXC. ELDORADO

SKU: yOS11121

Oil Pans

All oil pans are vatted, and checked for defects that would cause them to be unusable, such as excessive rust on sealing surfaces, cracks, holes, and severe warpage.

[Read More](#)

Price: \$150.00



OS11111 '68-'76 FRONT SUMP OIL PAN ALL EXC. ELDORADO

SKU: yOS11111

Oil Pans

All oil pans are vatted, and checked for defects that would cause them to be unusable, such as excessive rust on sealing surfaces, cracks, holes, and severe warpage.

[Read More](#)

Price: \$150.00



OS00101 OIL SLINGER

SKU: yOS00101

Oil Slinger

[Read More](#)

Price: \$65.00



GS31101 EXHAUST MANIFOLD GASKETS

SKU: GS31101

Stock Replacement Exhaust Manifold Gaskets

[Read More](#)

Price: \$20.00



EX25122 '80-'85 368 RWD DRIVER'S SIDE EXHAUST MANIFOLD

SKU: EX25122

Reconditioned '80-'85 RWD Driver's Side Exhaust Manifolds w/ indentions and rectangular ports.

[Read More](#)

Price: \$200.00



EX25108 '77-'79 425 ELDORADO DRIVER'S SIDE EXHAUST MANIFOLD

SKU: EX25108

Reconditioned '77-'79 425 Eldorado Driver's Side Exhaust Manifold

[Read More](#)

Price: \$325.00



EX25107 '77-'79 425 RWD DRIVER'S SIDE EXHAUST MANIFOLD

SKU: EX25107

Reconditioned '77-'79 425 RWD Driver's Side Exhaust Manifold

[Read More](#)

Price: \$275.00



EX25106 '77-'79 425 PASSENGER'S SIDE EXHAUST MANIFOLD

SKU: EX25106

Reconditioned '77-'79 425 Passenger's Side (RWD and Eldo)

[Read More](#)

Price: \$325.00



EX25105 '68-'76 ELDORADO DRIVER'S SIDE EXHAUST MANIFOLD

SKU: EX25105

Reconditioned '68-'76 Eldorado Driver's Side Exhaust Manifold

[Read More](#)

Price: \$325.00



EX25104 '68-'72 ELDORADO PASSENGER'S SIDE EXHAUST MANIFOLD

SKU: EX25104

Reconditioned '68-'72 Eldorado Passenger's Side Exhaust Manifold

[Read More](#)

Price: \$325.00



EX25103 '68-'76 RWD DRIVER'S SIDE EXHAUST MANIFOLD

SKU: EX25103

Reconditioned '68-'76 RWD Driver's Side Exhaust Manifold

[Read More](#)

Price: \$250.00



EX25101 '68-'76 RWD AND '73-'76 ELDORADO PASSENGER'S SIDE EXHAUST MANIFOLD (CONE)

SKU: EX25101

Reconditioned '68-'76 RWD and '73-'76 Eldo Passenger's Side
With cone for connecting the exhaust down-pipe directly to the manifold.

[Read More](#)

Price: \$275.00

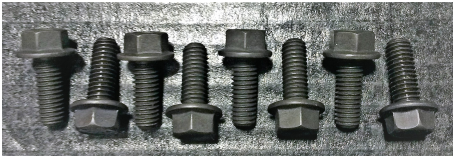

EX20102 EXHAUST MANIFOLD BOLT SET, SHORT (8 BOLT SET) BLACK FLANGE HEAD HEX BOLTS

SKU: EX20102

Short exhaust manifold bolts (1" long bolts), 1/2 set (8 bolts) 2 sets
required per engine.

[Read More](#)

Price: \$12.00

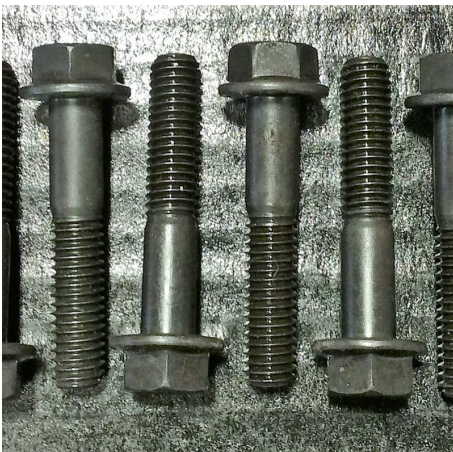

EX20101 EXHAUST MANIFOLD BOLT SET, LONG (8 BOLT SET) BLACK FLANGE HEAD HEX BOLTS

SKU: EX20101

Long exhaust manifold bolts (2" long bolts), 1/2 set (8 bolts) 2 sets
required per engine.

[Read More](#)

Price: \$12.00



CS45110 STRAIGHT WATER NECK (USED)

SKU: yCS45110

Straight Water Neck

[Read More](#)

Price: \$25.00



CS45020 OE 368 ANGLED WATER NECK

SKU: yCS45020

OE angled 368 Water Neck *Will not clear aftermarket intake*

[Read More](#)

Price: \$50.00

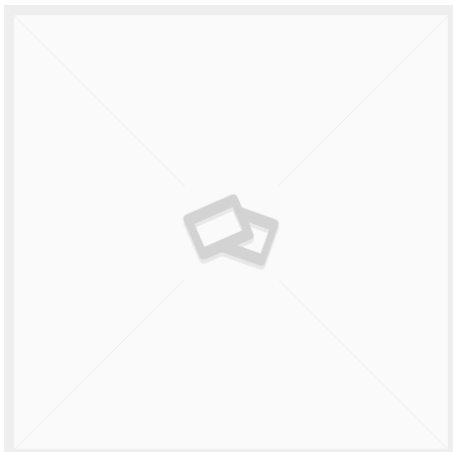

AF72009 - OE '80-'85 368 EFI INTAKE

SKU: yAF72009

OE Intake Manifold - '80-'85 Throttle-Body Fuel Injected 368

[Read More](#)

Price: \$350.00

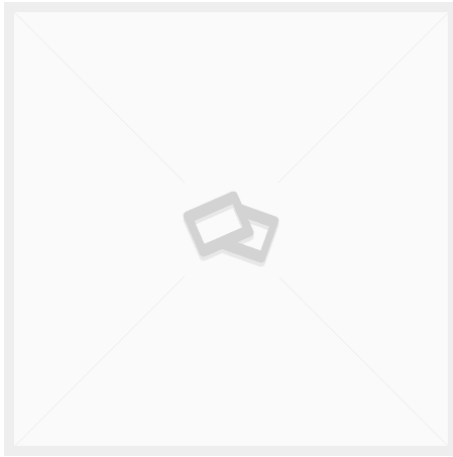

AF72008 - OE '80-'85 368 CARB INTAKE

SKU: yAF72008

OE Intake Manifold - '80-'85 Carbureted 368

[Read More](#)

Price: \$175.00

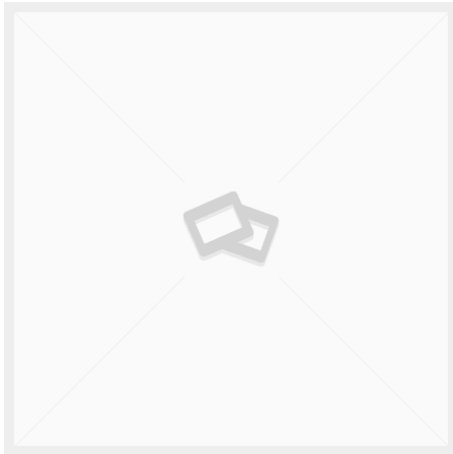

AF72007 - OE '77-'79 425 EFI INTAKE

SKU: yAF72007

OE Intake Manifold - '77-'79 Multi-Port Fuel Injected 425

[Read More](#)

Price: \$350.00

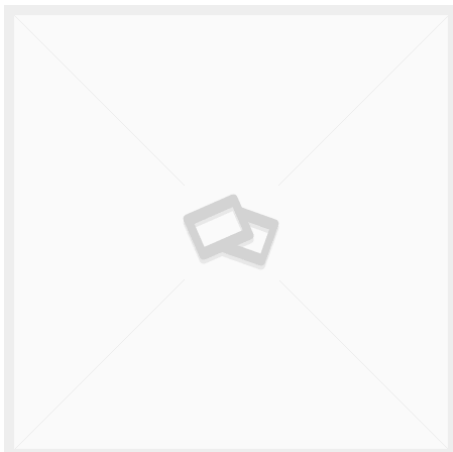

AF72006 - OE '77-'79 425 CARB INTAKE

SKU: yAF72006

OE Intake Manifold - '77-'79 Carbureted 425

[Read More](#)

Price: \$175.00

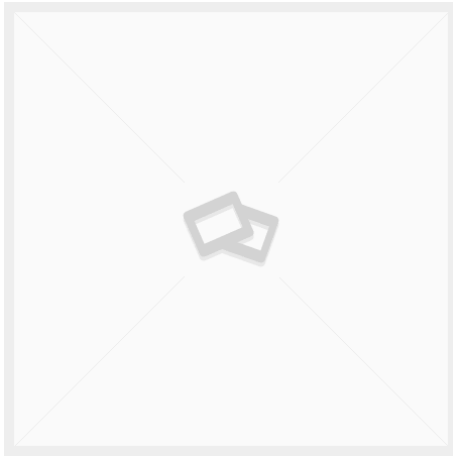

AF72005 - OE '74-'76 472 / 500 EFI INTAKE

SKU: yAF72005

OE Intake Manifold - '74-'76 Multi-Port Fuel Injected 472 / 500

[Read More](#)

Price: \$350.00

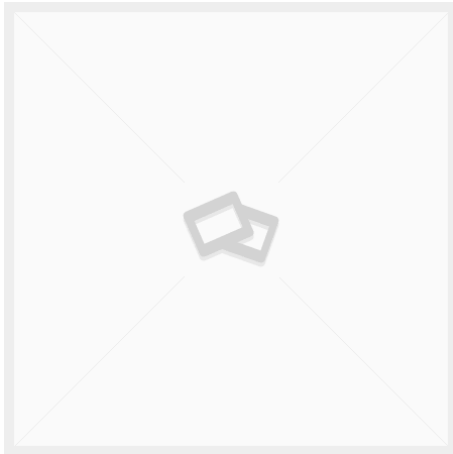

AF72004 - OE '74-'76 472 / 500 CARB INTAKE

SKU: yAF72004

OE Intake Manifold - '74-'76 Carbureted 472 / 500

With EGR

With no choke well

[Read More](#)

Price: \$175.00

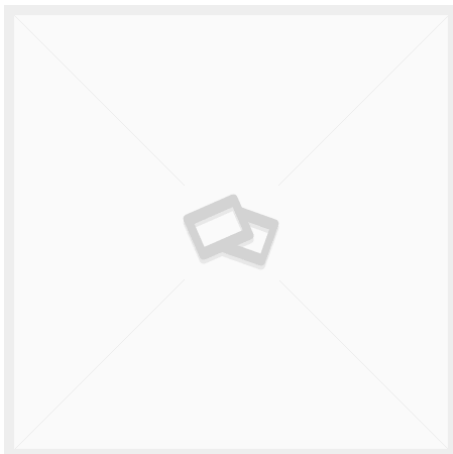

AF72003 - OE '70-'73 472 / 500 CARB INTAKE

SKU: yAF72003

OE Intake Manifold - late-'70-'73 Carbureted 472 / 500

With EGR

With round choke well

[Read More](#)

Price: \$175.00

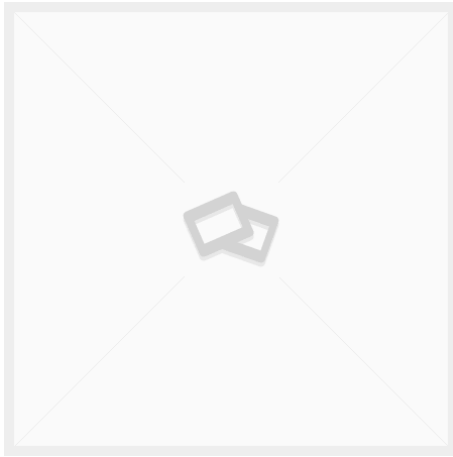

AF72002 - OE '70 472 / 500 CARB INTAKE

SKU: yAF72002

OE Intake Manifold - early-'70 Carbureted 472 / 500

Without EGR

With round choke well

Without trough across front of carb flange

[Read More](#)

Price: \$275.00

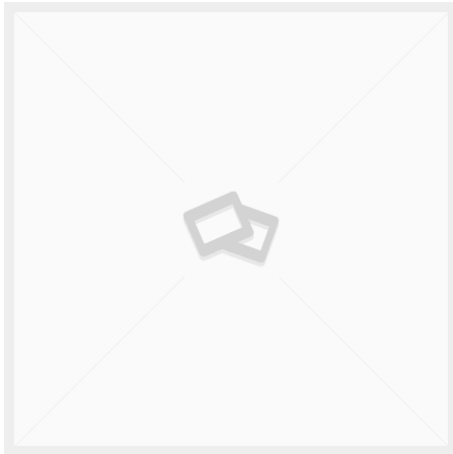

AF72001 - OE '68-'69 472 CARB INTAKE

SKU: yAF72001

OE Intake Manifold - 68/69 Carbureted 472

With rectangular choke well

With trough across front of carb mounting flange

[Read More](#)

Price: \$175.00

AIR AND FUEL DELIVERY

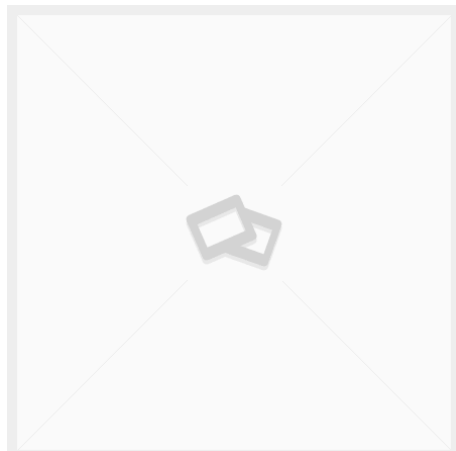

AF72009 - OE '80-'85 368 EFI INTAKE

SKU: yAF72009

OE Intake Manifold - '80-'85 Throttle-Body Fuel Injected 368

[Read More](#)

Price: \$350.00

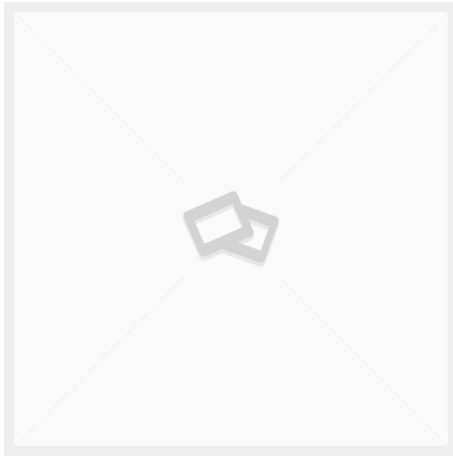

AF72008 - OE '80-'85 368 CARB INTAKE

SKU: yAF72008

OE Intake Manifold - '80-'85 Carbureted 368

[Read More](#)

Price: \$175.00

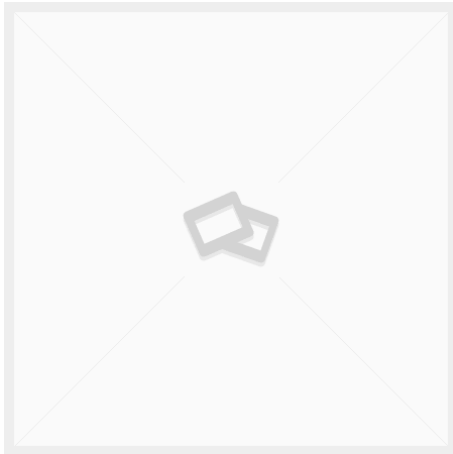

AF72007 - OE '77-'79 425 EFI INTAKE

SKU: yAF72007

OE Intake Manifold - '77-'79 Multi-Port Fuel Injected 425

[Read More](#)

Price: \$350.00

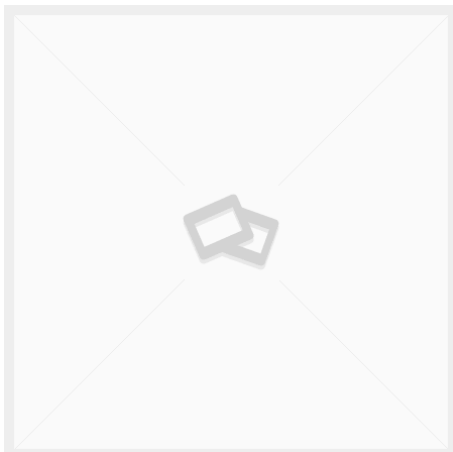

AF72006 - OE '77-'79 425 CARB INTAKE

SKU: yAF72006

OE Intake Manifold - '77-'79 Carbureted 425

[Read More](#)

Price: \$175.00

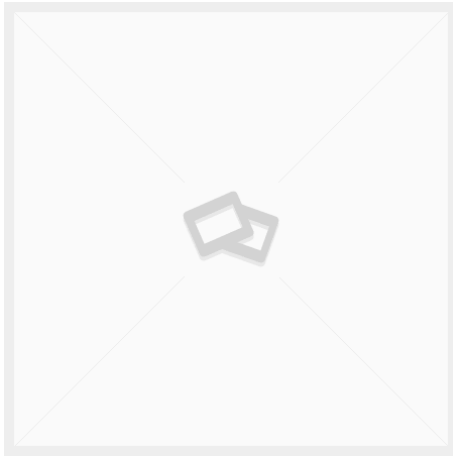

AF72005 - OE '74-'76 472 / 500 EFI INTAKE

SKU: yAF72005

OE Intake Manifold - '74-'76 Multi-Port Fuel Injected 472 / 500

[Read More](#)

Price: \$350.00

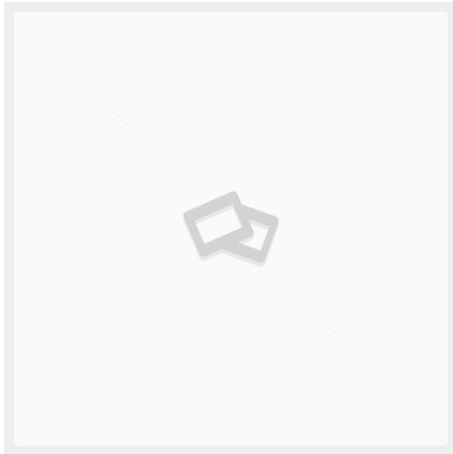

AF72004 - OE '74-'76 472 / 500 CARB INTAKE

SKU: yAF72004

OE Intake Manifold - '74-'76 Carbureted 472 / 500

With EGR

With no choke well

[Read More](#)

Price: \$175.00

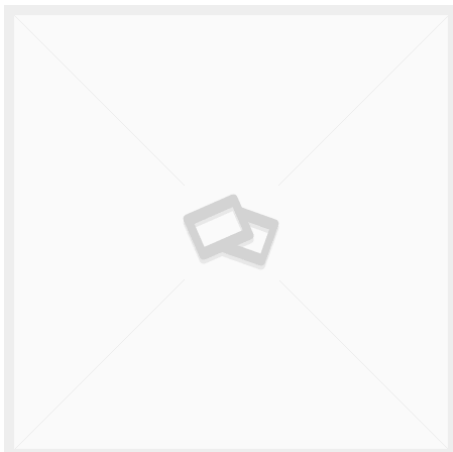

AF72003 - OE '70-'73 472 / 500 CARB INTAKE

SKU: yAF72003

OE Intake Manifold - late-'70-'73 Carbureted 472 / 500

With EGR

With round choke well

[Read More](#)

Price: \$175.00

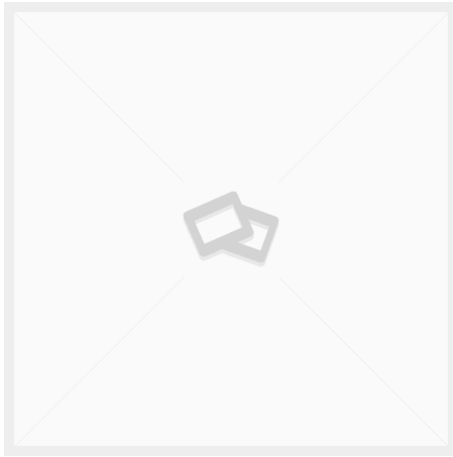

AF72002 - OE '70 472 / 500 CARB INTAKE

SKU: yAF72002

OE Intake Manifold - early-'70 Carbureted 472 / 500

Without EGR

With round choke well

Without trough across front of carb flange

[Read More](#)

Price: \$275.00

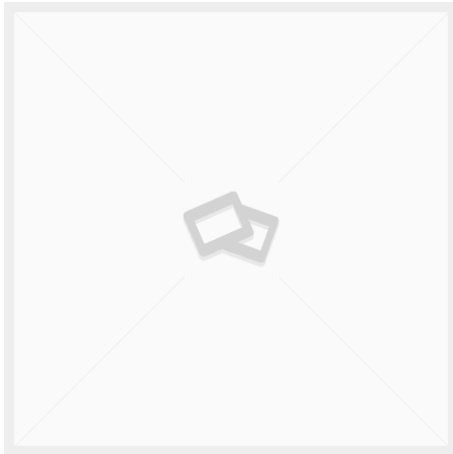

AF72001 - OE '68-'69 472 CARB INTAKE

SKU: yAF72001

OE Intake Manifold - 68/69 Carbureted 472

With rectangular choke well

With trough across front of carb mounting flange

[Read More](#)

Price: \$175.00

ROTATING AND BOTTOM END PARTS

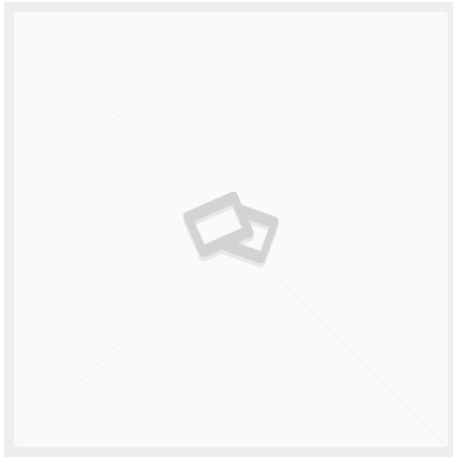

PB11101 - OE CRANK HUB

SKU: yPB11101

Original crankshaft hub

[Read More](#)

Price: \$95.00

OIL PANS

All oil pans are vatted, and checked for defects that would cause them to be unusable, such as excessive rust on sealing surfaces, cracks, holes, and severe warpage. These are 30-40 year old sheet metal parts, and are not perfect. Sometimes we have nice pans. Sometimes we

have fairly rough pans for a lower price (needing some elbow grease before use, but not requiring welding, etc). Sometimes we have both, and sometimes we have neither

Note: '77-up oil pans may require clearancing to clear the stroke of a 500.



OS11151 '80-'85 REAR SUMP OIL PAN ELDORADO 1 DRAIN PLUG

SKU: yOS11151

Oil Pans

All oil pans are vatted, and checked for defects that would cause them to be unusable, such as excessive rust on sealing surfaces, cracks, holes, and severe warpage.

[Read More](#)

Price: \$250.00



OS11132 '77-'78 REAR SUMP OIL PAN ELDORADO - 1 DRAIN PLUG

SKU: yOS11132

Oil Pans

All oil pans are vatted, and checked for defects that would cause them to be unusable, such as excessive rust on sealing surfaces, cracks, holes, and severe warpage.

[Read More](#)

Price: \$250.00





OS11131 '68-'76 REAR SUMP OIL PAN ELDORADO (2 DRAIN PLUGS)

SKU: yOS11131

Oil Pans

All oil pans are vatted, and checked for defects that would cause them to be unusable, such as excessive rust on sealing surfaces, cracks, holes, and severe warpage.

[Read More](#)

Price: \$250.00



OS11121 '77-'85 MID SUMP OIL PAN ALL EXC. ELDORADO

SKU: yOS11121

Oil Pans

All oil pans are vatted, and checked for defects that would cause them to be unusable, such as excessive rust on sealing surfaces, cracks, holes, and severe warpage.

[Read More](#)

Price: \$150.00



OS11111 '68-'76 FRONT SUMP OIL PAN ALL EXC. ELDORADO

SKU: yOS11111

Oil Pans

All oil pans are vatted, and checked for defects that would cause them to be unusable, such as excessive rust on sealing surfaces, cracks, holes, and severe warpage.

[Read More](#)

Price: \$150.00

PULLEYS BRACKETS AND ACCESSORIES



PB64111 ALTERNATOR BRACKET SET (W/ AIR PUMP MOUNTING PROVISION)

SKU: yPB64111

Alternator Bracket Set w/ AIR pump mounting provision

[Read More](#)

Price: \$65.00



PB64110 ALTERNATOR BRACKET SET (W/O AIR PUMP MOUNTING PROVISION)

SKU: yPB64110

Alternator Bracket Set Without AIR pump mounting provision

[Read More](#)

Price: \$105.00

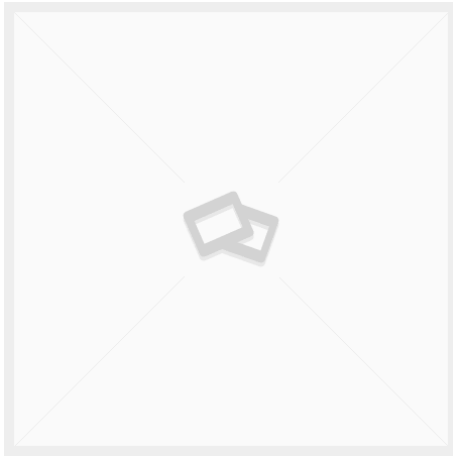

PB53001 - OE POWER STEERING BRACKET

SKU: yPB53001

OE Power Steering Bracket

[Read More](#)

Price: \$195.00

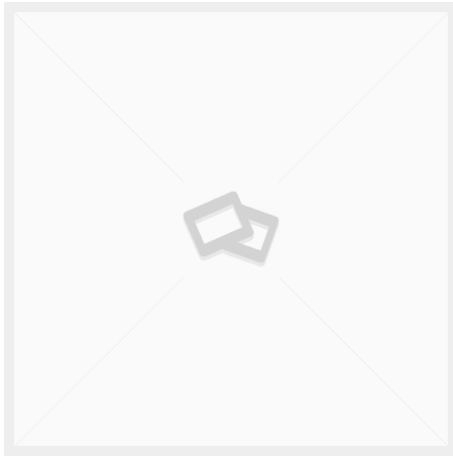

PB35112 - OE '77-'79 425 AC BRACKET SET

SKU: yPB35112

'77-'79 425 AC Bracket Set 2 pieces, for A6 compressor

[Read More](#)

Price: \$150.00

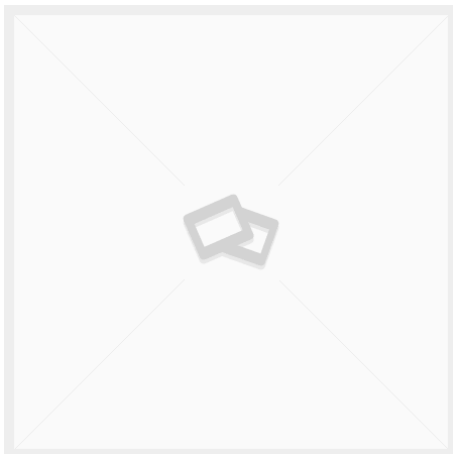

PB35111 '68-'76 472 / 500 AC BRACKET SET

SKU: yPB35111

'68-'76 472 / 500 AC Bracket Set

[Read More](#)

Price: \$150.00

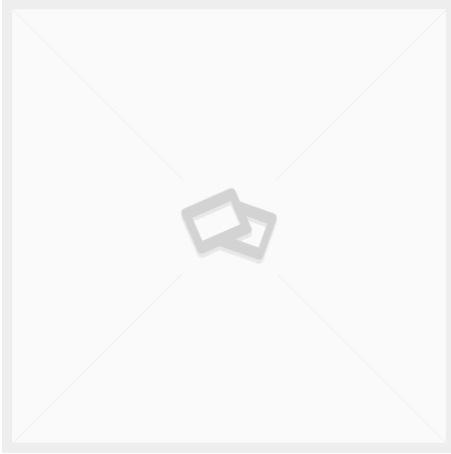

PB34110 '80-'85 AC BRACKET SET 2 PCS. - R4 COMPRESSOR

SKU: yPB34110

'80-'85 AC Bracket Set 2 pieces, for R4 compressor

[Read More](#)

Price: \$180.00



PB18032 BILLET ALUMINUM CRANK AND WATER PUMP PULLEY SET, 2-GROOVE PS / AC, WITH SMOG ('68/'69 AND '71-'73 STYLE)

SKU: PB18032

3 groove crank, 2 groove WP

[Read More](#)

Price: \$600.00



PB18021 BILLET ALUMINUM CRANK AND WATER PUMP PULLEY SET, NON-SMOG (1974-UP STYLE)

SKU: PB18021

2 groove crank, 1 groove WP

[Read More](#)

Price: \$599.00

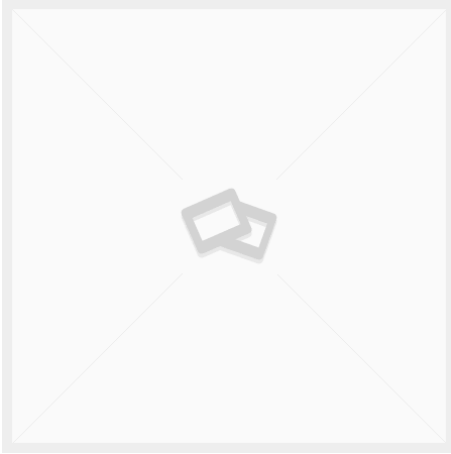

PB11101 - OE CRANK HUB

SKU: yPB11101

Original crankshaft hub

[Read More](#)

Price: \$95.00

REMAN EXHAUST MANIFOLDS

All reconditioned manifolds are cleaned, magnafluxed, shot peened, magnafluxed again, checked for flat gasket surfaces and machined as needed, and have new studs installed as needed. We do not weld up cracked manifolds for sale. Reconditioned manifolds are guaranteed to not be cracked at the time of delivery. New replacement left side manifolds are available ('68-'76 style, both Eldo and RWD versions). Note that most '68-'72 Eldorados have a unique side-exit passenger's side manifold, but most '73-up Eldorados used the same passenger's side manifold (down-exit) as the other cars. Please check the original manifold style on your car before ordering. Some passenger's side manifolds have an EFE valve, and some don't.



GS31101 EXHAUST MANIFOLD GASKETS

SKU: GS31101

Stock Replacement Exhaust Manifold Gaskets

[Read More](#)

Price: \$20.00





EX25122 '80-'85 368 RWD DRIVER'S SIDE EXHAUST MANIFOLD

SKU: EX25122

Reconditioned '80-'85 RWD Driver's Side Exhaust Manifolds w/ indentions and rectangular ports.

[Read More](#)

Price: \$200.00



EX25108 '77-'79 425 ELDORADO DRIVER'S SIDE EXHAUST MANIFOLD

SKU: EX25108

Reconditioned '77-'79 425 Eldorado Driver's Side Exhaust Manifold

[Read More](#)

Price: \$325.00



EX25107 '77-'79 425 RWD DRIVER'S SIDE EXHAUST MANIFOLD

SKU: EX25107

Reconditioned '77-'79 425 RWD Driver's Side Exhaust Manifold

[Read More](#)

Price: \$275.00



EX25106 '77-'79 425 PASSENGER'S SIDE EXHAUST MANIFOLD

SKU: EX25106

Reconditioned '77-'79 425 Passenger's Side (RWD and Eldo)

[Read More](#)

Price: \$325.00

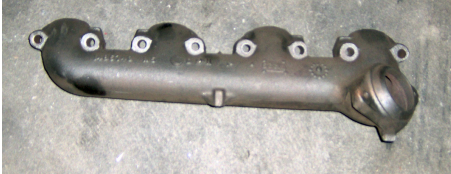

EX25105 '68-'76 ELDORADO DRIVER'S SIDE EXHAUST MANIFOLD

SKU: EX25105

Reconditioned '68-'76 Eldorado Driver's Side Exhaust Manifold

[Read More](#)

Price: \$325.00



EX25104 '68-'72 ELDORADO PASSENGER'S SIDE EXHAUST MANIFOLD

SKU: EX25104

Reconditioned '68-'72 Eldorado Passenger's Side Exhaust Manifold

[Read More](#)

Price: \$325.00

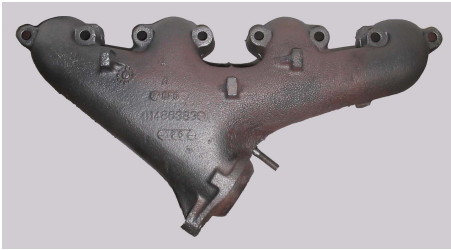

EX25103 '68-'76 RWD DRIVER'S SIDE EXHAUST MANIFOLD

SKU: EX25103

Reconditioned '68-'76 RWD Driver's Side Exhaust Manifold

[Read More](#)

Price: \$250.00



EX25101 '68-'76 RWD AND '73-'76 ELDORADO PASSENGER'S SIDE EXHAUST MANIFOLD (CONE)

SKU: EX25101

Reconditioned '68-'76 RWD and '73-'76 Eldo Passenger's Side
With cone for connecting the exhaust down-pipe directly to the manifold.

[Read More](#)

Price: \$275.00



EX20102 EXHAUST MANIFOLD BOLT SET, SHORT (8 BOLT SET) BLACK FLANGE HEAD HEX BOLTS

SKU: EX20102

Short exhaust manifold bolts (1" long bolts), 1/2 set (8 bolts) 2 sets required per engine.

[Read More](#)

Price: \$12.00

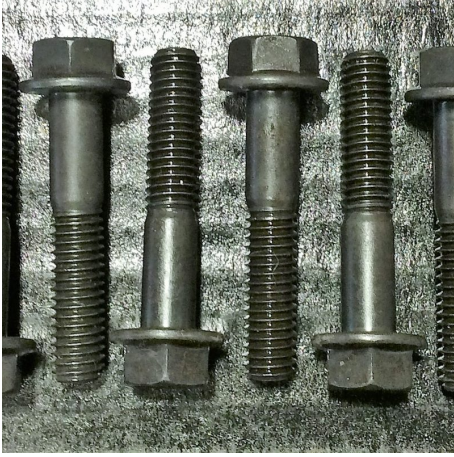

EX20101 EXHAUST MANIFOLD BOLT SET, LONG (8 BOLT SET) BLACK FLANGE HEAD HEX BOLTS

SKU: EX20101

Long exhaust manifold bolts (2" long bolts), 1/2 set (8 bolts) 2 sets required per engine.

[Read More](#)

Price: \$12.00

INDEX

A

- AF12010 Q-Jet Carburetor - 795 CFM with Cadillac Linkage and Electric Choke 35, 46
- AF12111 Q-Jet Carburetor - '69 Spec 750 CFM with Cadillac Linkage and Divorced Choke 35, 46
- AF12112 Q-Jet Carburetor - '73-'74 Spec 795 CFM with Cadillac Linkage and Divorced Choke 34, 45
- AF12210 Q-Jet Carburetor - 795 CFM with Chevy Linkage and Electric Choke 34, 45
- AF12510 Street Demon 625 CFM 33, 45
- AF12520 Street Demon 750 CFM 33, 44
- AF28020 Q-jet Tuning Kit 33, 44
- AF40010 Steel Fuel Line 5/16" 32, 61
- AF40011 Stainless Steel Fuel Line 5/16" 32, 61
- AF40012 Steel Fuel Line 3/8" 32, 61
- AF40013 Stainless Steel Fuel Line 3/8" 31, 60
- AF51003 Used Fuel Pump Eccentric 31, 67
- AF51110 OE Replacement Fuel Pump 31, 67
- AF51210 Chrome Mechanical Fuel Pump 30, 66
- AF51230 High Performance Mechanical Fuel Pump 30, 66
- AF51250 Racing Mechanical Fuel Pump 29, 65
- AF53021 In-Tank Pump & Baffle Retrofit Kit 29, 58, 65
- AF53111 Billet Aluminum Fuel Pump Block Off 29, 65
- AF56010 Adjustable Fuel Pressure Regulator (carb) 28, 64
- AF56101 Adjustable Bypass Style Fuel Pressure Regulator (carb) 28, 64
- AF56201 Adjustable Bypass Style Fuel Pressure Regulator (carb or fuel injected) 28, 64
- AF56301 Adjustable Bypass Style Fuel Pressure Regulator (fuel injected) 27, 63
- AF56302 Adjustable Bypass Style Fuel Pressure Regulator (high pressure fuel injected) 27, 63
- AF58101 Fuel Filter 2 1/16" for 1968-1975 27, 44, 60, 63
- AF58102 Fuel Filter 1976-up 2" long 26, 60
- AF58103 Fuel Filter 1" paper 26, 43, 59, 62
- AF58201 Fuel Filter 1968 Replacement 25, 43, 59, 62
- AF61110 Blower Kit 25, 41
- AF65110 ProCharger D1SC kit for 472 / 500 25, 41
- AF70102 Flange Head Intake Bolt Kit - Stainless Steel 24, 72
- AF70201 EGR Block Off for OE Intakes, Billet Aluminum 24, 72, 128
- AF71105 Small Single Plane Intake Standard (square bore (4150) style) 24, 71
- AF71475 BoogieMan™ Single Plane Intake 23, 71
- AF71480 BoogieMan™ Tunnel Ram 23, 71
- AF72001 - OE '68-'69 472 Carb Intake 486, 490
- AF72002 - OE '70 472 / 500 Carb Intake 486, 490
- AF72003 - OE '70-'73 472 / 500 Carb Intake 485, 489
- AF72004 - OE '74-'76 472 / 500 Carb Intake 485, 489
- AF72005 - OE '74-'76 472 / 500 EFI Intake 485, 489
- AF72006 - OE '77-'79 425 Carb Intake 484, 488
- AF72007 - OE '77-'79 425 EFI Intake 484, 488
- AF72008 - OE '80-'85 368 Carb Intake 484, 488
- AF72009 - OE '80-'85 368 EFI Intake 483, 487
- AF72115 Edelbrock™ 2115 23, 70
- AF72215 Cad Company PRO/Cad™ III 22, 70
- AF80101 Cylinder Head Bolts New (stock style cylinder head bolts) 22, 55, 57, 187, 195
- AF80110 ARP™ Head Stud Kit 187, 195
- AF80113 BoogieMan™ Head Stud Kit 22, 55, 57
- AF80114 BoogieMan™ Head Stud Conversion Kit 21, 54, 57
- AF81100 Premium Re-manufactured Stock Heads 21, 54
- AF81110 '68-'73 472 / 500 Premium Re-manufactured Stock Heads Small chamber 76cc 20, 53
- AF81120 '74-'76 472 / 500 Premium Re-manufactured Stock Heads Large Chamber 120cc 20, 53
- AF81130 '77-'79 425 Premium Re-manufactured Stock Heads 19, 52
- AF81210 Super/Street Iron Heads Small Chamber 19, 52
- AF81220 Super/Street Steel Heads Large Chamber 18, 51
- AF81300 Pro/Street Iron heads 18, 51
- AF81310 Pro Street Heads Small Chamber 17, 50
- AF81320 PRO/Street Iron Heads Large Chamber 17, 50
- AF81400 PRO/COMP Iron heads 17, 50
- AF81410 Pro/Comp Iron Heads Small Chamber 16, 49
- AF81420 PRO/Comp Heads Large Chamber 16, 49
- AF85141 Factory Replacement Aluminum Heads 15, 48



AF85400 BoogieMan™ Aluminum Heads 15, 48
AF90020 Air Cleaner Stud Kit, Universal 14, 40
AF91010 Air Filter Dropped Base 14" 14, 39
AF91011 Spun Aluminum Air Cleaner Drop Base, Offset Mount 14, 39
AF92010 Spun Aluminum Air Cleaner Top With integral air deflection cone 13, 39
AF93250 Moroso 5" Air Filter 13, 38
AF93401 K&N Air Filter 13, 38
AF93425 K&N 2 ½" Air Filter 12, 38
AF96101 Chrome Air Cleaner Kit 12, 37
AF96102 Chrome Air Cleaner Kit (drop base) 12, 37
AF96104 Chrome Air Cleaner Kit 11, 37
AF96225 Spun Aluminum Air Cleaner Kit - Short 11, 36
AF96225 Spun Aluminum Air Cleaner Kit - Tall 11, 36

B

BH10000 Head Water Outlet Kit, Threaded 90° 83, 87
BH11011 Cad Company Block Hardware Kit 83, 86, 267, 275
BH11081 Oil Galley Press In Plugs 266, 274
BH11091 Smog Passage Press In Plugs 265, 274
BH11092 Rear Cam Plug Steel 265, 274
BH11094 Head Coolant Plug, Cup Style Steel 265, 273
BH11392 Rear Cam Plug Brass 264, 273
BH11394 Head Coolant Plug, Cup Style Brass 264, 272
BH11395 Head Coolant Plug, Cup Style 83, 86
BH11X93 Block Expansion Plugs (Steel or Brass) 82, 86, 263, 272
BH12096 Head Coolant Plug, Disc Style Steel 263, 272
BH12396 Head Coolant Plug, Disc Style, Brass 82, 85, 263, 271
BH13091 Head Coolant Plug, Threaded 262, 271
BH13143 Oil Galley Threaded Plug 81, 85, 262, 270
BH13172 Block Coolant Plug, Threaded 81, 85
BH13371 Block Coolant Sensor Holes, Threaded Plug 81, 84
BH15001 Freeze Plug Kit (Standard) Steel 262, 270
BH15013 Freeze Plug Kit for 425 Heads 10, 47, 56, 80, 84
BH15301 Freeze Plug Kit (Standard) Brass 261, 270

C

Cadillac 500 Engine CC89 3, 5
CC95 Cadillac 472 Complete Engine 2, 5
CS21101 New Stock Replacement Water Pump (Early Style) 80, 93
CS21102 New Replacement Water Pump (Late Style) 80, 93
CS25001 Chevy Water Pump Adapter Kit Billet Aluminum 79, 93
CS25101 High Volume Water Pump (Early Style), by FlowKooler 79, 92
CS25102 High Volume Water Pump (Late Style), by FlowKooler 79, 92
CS41101 Thermostat, Standard, 180 degree Low Temp 78, 91
CS41102 Thermostat, Standard, 195 degree OE Temp 78, 90
CS41121 Thermostat, High Flow, 180 degree Low Temp 78, 90
CS45020 OE 368 Angled Water Neck 483
CS45110 Straight Water Neck (Used) 483
CS45111 Thermostat Housing / Water Neck Billet Aluminum 77, 90
CS45121 Thermostat Housing / Water Neck, 1" Offset Billet Aluminum 77, 89
CS65101 Radiator Cap 20 PSI 77, 88
CS81101 Low Profile Flex Fan Kit, Blue 358, 367
CS81102 Low Profile Flex Fan Kit, Red 358, 367

D

DS10111 Flexplate Bolts ARP Chromoly 103, 109, 187, 192
DS10112 Flexplate and Flywheel Bolts, ARP Chromoly 103, 108, 186, 192
DS10113 Flexplate and Flywheel Bolts, ARP, Pro-series Chromoly 102, 108, 186, 192
DS12101 OE Spec Stamped Steel Flexplate Stock (replacement - solid style) 102, 108
DS12102 Performance Stamped Steel Flexplate Dual Pattern 102, 107
DS12103 Performance Stamped Steel Flexplate Dual pattern, SFI certified 101, 107
DS12111 Billet Steel Flexplate (Multi-Pattern) 101, 107
DS12121 Billet Steel Flywheel (standard clutches) 101, 106
DS12123 Billet Steel Flywheel for Pull Type Clutches 100, 106
DS12125 Billet Steel Flywheel for Long Style Clutches 100, 106
DS12211 Billet Steel 429 Flexplate (Multi-Pattern) 100, 105
DS12213 Billet Steel 429 Flexplate (Multi-Pattern) with factory adapter. 99, 105
DS12221 Billet Steel 429 Flywheel (standard clutches) 99, 105
DS13101 Cadillac Pilot Bushing For manual transmission 99, 104
DS20131 Starter Support Strap 98, 112



DS20141 Starter Bolts OE Style for Full Size Starter RWD 98, 111, 186, 191
DS22101 HD High Torque Starter (Fits all RWD) 98, 111
DS22113 Eldorado Starter 97, 111
DS24101 Mini Starter 97, 110
DS24102 Mini Starter Nose Cone Upgrade 97, 110
DS31101 Cadillac to Chevy Transmission Adapter 96, 115, 357, 364
DS31103 Cadillac 472/500/425/368 to Cadillac 429 Spec TH400 Transmission Adapter 96, 114, 357, 367
DS31111 Torque Converter Adapter 95, 104, 114
DS31201 Cadillac 429 to Chevy Transmission Adapter 95, 114, 357, 363
DS31203 Cadillac 429 to BOP / Cadillac Transmission Adapter 95, 113, 356, 363
DS53111 Transmission Pan TH425 94, 116
Dual Sync Distributor 4, 207, 216

E

EX20101 Exhaust Manifold Bolt Set, Long (8 bolt set) Black Flange Head Hex Bolts 128, 133, 185, 191, 482, 502
EX20102 Exhaust Manifold Bolt Set, Short (8 bolt set) Black Flange Head Hex Bolts 127, 133, 185, 191, 482, 501
EX20111 Exhaust Manifold Collector Studs w/ Brass Nuts 127, 133, 185, 190
EX21105 '68-'76 Eldorado Left Side Manifold New, imported 127, 132
EX25101 '68-'76 RWD and '73-'76 Eldorado Passenger's Side Exhaust Manifold (cone) 126, 132, 482, 501
EX25103 '68-'76 RWD Driver's Side Exhaust Manifold 126, 132, 481, 501
EX25104 '68-'72 Eldorado Passenger's Side Exhaust Manifold 126, 131, 481, 500
EX25105 '68-'76 Eldorado Driver's Side Exhaust Manifold 125, 131, 481, 500
EX25106 '77-'79 425 Passenger's Side Exhaust Manifold 125, 131, 480, 500
EX25107 '77-'79 425 RWD Driver's Side Exhaust Manifold 125, 130, 480, 499
EX25108 '77-'79 425 Eldorado Driver's Side Exhaust Manifold 124, 130, 480, 499
EX25122 '80-'85 368 RWD Driver's Side Exhaust Manifold 124, 130, 479, 499
EX40101 Header Bolt Set (12 point black oxide bolts) 124, 140, 184, 190
EX40102 Header Bolt Lock Washer Kit 184, 190
EX41100 Block Huggers Street rod style, center exit 123, 139
EX41110 '68-'76 RWD Cadillac Headers 123, 139
EX41120 '68-'78 Eldorado Headers 123, 138
EX41130 Universal Rear-Exit Headers 122, 138
EX41140 G-body Headers 122, 138
EX41160 '59-'64 Cadillac Headers with 472 / 500 / 425 Swap, 1 3/4" 121, 137
EX63100 Header Install Kit 121, 137
EX67122 3/8" Header Flanges (1 Pair) 121, 136
EX67132 3/8" BoogieMan D-Port Header Flanges (1 Pair) 120, 136

G

GS10211 Carb Gasket '67-'70 10, 43, 158, 178
GS10212 Carb Gasket '70-'84 10, 42, 157, 177
GS10213 Carb Gasket, 1/4" Thick '70-'84 9, 42, 157, 177
GS21101 Steel (OE Style) Valley Pan Intake Gasket 157, 177
GS21102 Heavy-Duty Laser Cut Steel Valley Pan 9, 70, 156, 176
GS21112 Cad Company Composite Intake Gaskets 156, 176
GS21122 BoogieMan™ Composite Intake Gaskets 8, 69, 155, 175
GS30113 Composite 3" Collector Gaskets 1 pr 120, 136, 155, 175
GS30122 SCE™ Copper Collector Gaskets 2.5" 154, 175
GS30123 SCE Copper 3" Collector Gaskets 1 pr 120, 135, 154, 174
GS30125 SCE™ Copper Collector Gaskets 3.5" 154, 174
GS30133 REMFLEX Compressed Graphite 3" Collector Gaskets 1 pr 119, 135, 153, 174
GS31101 Exhaust Manifold Gaskets 119, 129, 153, 173, 479, 498
GS31111 Cad Company Composite Header Gaskets 153, 173
GS31112 Cad Company BoogieMan™ Composite Header Gaskets 152, 173
GS31121 SCE Copper Header Gaskets 8 individual gaskets 119, 135, 152, 172
GS31131 Compressed Graphite Header Gaskets 118, 134, 152, 172
GS41101 Oil Pan Gasket Set 151, 167
GS41102 Cad Company Oilpan Gasket Set 150, 166
GS41201 Oil Pump Gasket 150, 166
GS41301 Neoprene 2 pc. Rear Main Seal 150, 165
GS41401 Timing Cover Gasket Set 149, 165
GS41402 Timing Cover Gasket for 472 / 500 149, 165, 423, 446
GS41602 StaTite™ Thermostat Gasket 76, 89, 149, 172
GS41603 Thermostat Gasket - OE Style 148, 171
GS41701 Fuel Pump Gasket 148, 164
GS51101 Fel-Pro™ (Blue) 472 / 500 CID OE Replacement Head Gaskets (ea.) 148, 163



GS51102 Cad Company™ 472 / 500 CID Performance Head Gaskets (ea.) 147, 163
GS51104 Cad Company™ ProCad™ 472 / 500 CID High Performance / Big-Bore Head Gaskets (ea.)
147, 162
GS511056 Cut Ring Head Gasket for 472 / 500 8, 47, 56, 147, 162
GS51111 Fel-Pro™ (Blue) 425 CID OE Replacement Head Gaskets (ea.) 146, 162
GS51201 SCE Titan Copper Head Gaskets (pr) 146, 161
GS51204 SCE™ Standard Copper Head Gaskets (pr.) 146, 161
GS51601 Valve Cover Gasket - Cork 145, 171
GS51612 Cad Company 2X Valve Cover Gaskets 145, 171, 379, 383
GS51701 Valve Cover Gasket - Neoprene 145, 170
GS61101 EGR Valve Gasket 144, 160
GS71101 Complete Engine Builder Gasket Set '68-'76 144, 160
GS71102 Fel-Pro / Sealed Power Complete Engine Builder Gasket Set '68-'76 144, 160
GS71112 Complete Engine Builder Gasket Set '77-'79 143, 159
GS71201 Complete Engine Builder Gasket Set Without Head Gaskets '68-'76 143, 159
GS80101 Brush On Gasket Sealer *Discontinued*** 143, 169
GS80102 Brush On Gasket Sealer 142, 169
GS80301 Right Stuff™ Gasket Maker 142, 168

H

Hogan Intake - Land speed extra 4, 8, 69

I

IG13110 Cad Company new HEI Distributor 207, 216
IG15101 MSD Pro Billet Distributor 207, 215
IG15112 Billet Standalone Small Cap Distributor, Red 206, 215
IG15113 Billet Standalone Small Cap Distributor, Black 206, 215
IG31102 Premium Electronic Ignition Conversion Kit 206, 217
IG33100 Tune-Up Kit for HEI 205, 222
IG35101 Distributor Clamp 205, 222
IG37002 Iron Distributor Gear for MSD 205, 213, 423
IG37011 Bronze Distributor Gear for OE Distributor 204, 212, 423
IG37012 Bronze Distributor Gear for MSD 204, 212, 422
IG37013 Distributor Shims 204, 212
IG37021 Melonized Distributor Gear for OE Distributor 203, 211, 422
IG37022 Melonized Distributor Gear for MSD 203, 211, 422
IG37031 Composite Distributor Gear for OE Distributor 203, 211, 421
IG37032 Composite Distributor Gear for MSD 202, 210, 421
IG51302 MSD BLaster 2 Coil 202, 220
IG55101 Pro-Style Coil 202, 219
IG55102 Race Style E-Coil 201, 219
IG55201 MSD Street Blaster Coil 201, 219
IG55202 MSD Blaster HVC Coil 201, 218
IG57302 Chrome Bracket and Coil Cover 200, 218
IG71101 MSD 6AL Control Unit 200, 221
IG71102 MSD 6A Control Unit 200, 221
IG95101 Belden 7mm Wires 199, 226
IG95201 Belden 8mm Wires 199, 225
IG95301 MSD 8.5mm Wires 199, 225
IG95311 Edelbrock 22710 Max-Fire (Ultra-Spark 50) high performance spark plug wire set 198, 210,
224
IG97203 Budget silicone Wire Loom Kit 198, 224
IG97204 Edelbrock 22799 spark plug wire separators 197, 209, 223
IG97301 MSD Wire Loom Clip Kits 197, 223

K

kDS31301 Transmission Adapter 331/365/390/429 to Chevy Transmission 94, 113
kEX45211 Headers 390/429 118
kSM11304 Motor Mount 61-65 356, 363
kVT91101 Cadillac Script Valve Covers 331-429 379, 388
kVT91102 Polished Cadillac Script Valve Covers 331/365/390/429 378, 388
kVT91103 Powder Coated Cadillac Script Covers 1949-1967 378, 388
kVT91111 Cadillac Cast Aluminum Valve Covers - Offenhauser script Call to order 378, 387
kVT91221 Finned Valley Cover 1949-1967 377, 387

M

MS31101 Cap With Logo Red 74
MS31102 Cap With Logo Khaki 74
MS31103 Cap With Logo Black 73

O

OL21101 Assembly Lube: Clevite™ Bearing Guard 261, 280
OL21111 Isky Rev Lube (valve train assembly lube) 421, 464
OL95111 Blue Dykem Layout Fluid 227
OS00101 Oil Slinger 479
OS10112 Oil Pan Stud Kit Stainless, (w/ serrated locking nuts) 184, 189, 235, 242
OS10151 Crank Scraper 235, 241, 261, 289, 295
OS11111 '68-'76 Front Sump Oil Pan All exc. Eldorado 478, 493
OS11121 '77-'85 Mid Sump Oil Pan All exc. Eldorado 478, 493
OS11131 '68-'76 Rear Sump Oil Pan Eldorado (2 drain plugs) 478, 493
OS11132 '77-'78 Rear Sump Oil Pan Eldorado - 1 drain plug 477, 492
OS11151 '80-'85 Rear Sump Oil Pan Eldorado 1 drain plug 477, 492
OS13122 Rear Sump Aluminum Oil Pan 234, 241, 356, 366
OS21111 Front Sump ('68-'76 RWD) Oil Pickup Tube 234, 244
OS21131 Mid Sump ('77-'79 RWD) Oil Pickup Tube OE Spec, Made in USA 234, 243
OS23121 Rear Sump Oil Pickup Tube 355, 366
OS23123 Rear Sump Oil Pickup Tube Made in USA 233, 243
OS30201 Oil Pump Drive Shaft New, fits '68-'85 472/500/472/368 engines 233, 247
OS31101 Oil Pump Rebuild Kit 233, 247
OS31111 OE Replacement "Standard Body" Oil Pump 232, 246
OS31112 OE Replacement "Special Chassis" Oil Pump 232, 246
OS31121 Gold Series "Standard Body" Oil Pump 232, 246
OS31122 Gold Series "Special Chassis" Oil Pump 231, 245, 355, 366
OS40010 Dipstick Tube Universal, OE 183, 231, 237, 241, 260, 269
OS40110 Dipstick Tube Chrome w/ Chrome Dipstick 183, 231, 237, 260, 269
OS40210 Dipstick Tube Stainless Steel w/ Chrome Dipstick 183, 230, 236, 260, 269
OS40220 Dipstick Tube Polished Stainless Steel w/ Chrome Dipstick 182, 230, 236, 259, 268
OS61123 Billet Oil Filter 230, 239
OS63011 Remote Oil Filter Adapter--Side Exit 229, 239, 355, 365
OS63012 Oil Filter Adapter Lines Exit Straight 229, 238, 354, 365
OS65011 Oil Cooler Adapter Sandwich style 229, 238

P

PB11101 - OE Crank Hub 477, 491, 497
PB11113 Crank Hub Sleeve 141, 164, 259, 288, 293, 317, 329
PB11122 Crank Hub Bolt and Washer Kit 182, 195, 259, 288, 293, 317, 329
PB11201 Billet Steel Crank Hub 258, 288
PB11202 Billet Steel Crank Hub (offset) 258, 287, 292
PB12306 Harmonic Damper w/ Hub, SFI certified 257, 287, 292, 316
PB13001 Billet Aluminum Timing Pointer 316, 329, 342
PB16102 Billet Aluminum Overdrive Water Pump Pulley 316, 328
PB18021 Billet Aluminum Crank and Water Pump Pulley set, Non-Smog (1974-up Style) 315, 328, 341, 476, 496
PB18022 Billet Aluminum Crank and Water Pump Pulleys, Single Groove PS / AC, With or Without Smog 315, 328
PB18023 Billet Aluminum Crank and Water Pump Pulleys, Single Groove PS / AC non-smog, With Overdrive WP 315, 327
PB18031 Billet Aluminum Crank and Water Pump Pulley Set, 2-Groove PS / AC, Non-Smog (1970 Style) 314, 327, 341
PB18032 Billet Aluminum Crank and Water Pump Pulley set, 2-Groove PS / AC, With Smog ('68/'69 and '71-'73 Style) 314, 327, 341, 476, 496
PB18760 Crank and Water Pump Pulleys, Single Serpentine 314, 326, 340, 350
PB18763 Crank and Water Pump Pulleys, Multi-Serpentine 313, 326
PB30411 R4 AC Compressor New (not rebuilt), Single V-Belt 313, 319
PB32102 R4 Clutch Cover Alternate retainer fitting 313, 318
PB34000 R4 Bracket Kit Billet Aluminum 7, 68, 312, 318, 325
PB34110 '80-'85 AC Bracket Set 2 pcs. - R4 compressor 476, 496
PB35111 '68-'76 472 / 500 AC Bracket Set 475, 495
PB35112 - OE '77-'79 425 AC Bracket Set 475, 495
PB50121 Steel 1 Groove Keyway Power Steering Pulley 312, 334, 340
PB50151 Billet 1 Groove Keyway Power Steering Pulley 312, 334, 340
PB50152 Billet 1 Groove Keyway Power Steering Pulley 311, 334, 339
PB50223 Steel 2 Groove Keyway Power Steering Pulley 311, 333, 338
PB50254 Billet 2 Groove Keyway Power Steering Pulley 310, 333, 338
PB51122 Steel 1 Groove Press Fit Power Steering Pulley 310, 332, 338
PB51153 Billet 1 Groove Press Fit Power Steering Pulley 310, 332, 337
PB52651 Billet Serpentine Keyway Power Steering Pulley 309, 332, 337, 349
PB53001 - OE Power Steering Bracket 475, 495
PB53621 Steel Serpentine Press Fit Power Steering Pulley 309, 331, 337, 349



PB53652 Billet Serpentine Press Fit Power Steering Pulley 309, 331, 336, 349
PB54211 Power Steering Pump, Black, with Keyed Shaft 308, 330
PB54311 Power Steering Pump, Chrome, with Keyed Shaft 308, 330
PB60312 Chrome Alternator 307, 322, 348
PB60313 Chrome One Wire Alternator W/Serpentine Pulley 307, 322, 348
PB61522 Alternator Pulley and Fan 307, 336
PB61523 Alternator Pulley and Fan 306, 336
PB62130 Dual Belt Alternator Pulley 306, 335
PB62311 Chrome Serpentine Alternator Pulley 306, 321, 335, 348
PB62510 Billet Serpentine Alternator Pulley 305, 321, 347
PB64110 Alternator Bracket Set (w/o AIR pump mounting provision) 474, 494
PB64111 Alternator Bracket Set (w/ AIR pump mounting provision) 474, 494
PB64120 High Mount Alternator Bracket Kit 305, 325, 347
PB64421 Stainless Alternator Bracket Kit 305, 324, 347
PB64500 Billet Aluminum Alternator Bracket Kit 304, 324, 346
PB71701 Serpentine Kit - Water Pump, AC, & Alternator (105 Amp) 304, 346
PB71702 Serpentine Kit - Water Pump, AC, Alternator (105 Amp) & Power Steering 304, 346
PB71704 Serpentine Kit - Water Pump, AC, Alternator (140 Amp) and Power Steering 303, 345
PB71705 Serpentine Kit - Water Pump, AC, Alternator (140 Amp) & Power Steering w/ Flowkooler Water Pump 303, 345
PB71771 Serpentine pulley and bracket kit for water pump and alternator 303, 345
PB71772 Serpentine pulley and bracket kit with chrome 105 Amp alternator 302, 344
PB71773 Serpentine pulley and billet bracket kit with polished aluminum 140 Amp alternator PB71773 302, 344
PB82820 6-Rib Serpentine Alternator Belt - Standard Length 302, 321, 323, 344
PB82821 6-Rib Serpentine Alternator Belt - Shorter belt for 'C'-type bracket 301, 320, 343

R

RB10131 Main Stud Kit ARP 4130 Chromoly - (w/ nuts and washers) 182, 194
RB10132 Long Main Stud Kit ARP 4130 Chromoly (w/ nuts and washers) 181, 194
RB19121 Halo Main Girdle Kit 257, 287, 292, 294
RB19123 Main Girdle Kit With Cap Supports 257, 286, 291, 294
RB19124 Stock Pan Girdle Set up 6
RB19302 Bottom End Kit 228, 240
RB30121 Rod Bolts ARP Chromoly w/ Nuts 181, 194
RB33113 HD Forged I Beam Rods 255, 285, 300
RB35112 HD Forged H Beam Rods 255, 285, 299
RB40111 Crank Key 181, 193, 255, 284, 291, 420, 464
RB51110 Silvolite Cast Replacement Pistons With Pins for Cadillac 472, 500, and 425 Engines 254, 284, 299
RB51120 Cast Replacement Pistons With Pins for Cadillac 472 and 500 Engines 254, 284, 299
RB51131 472 Pistons 10:1 Comp Ratio W/76cc heads 254, 283, 298
RB53111 Keith Black Flat Top Pistons 1974-1976 253, 283, 298
RB53114 Keith Black 10:1 Pistons For 500CID 253, 283, 298
RB53116 Keith Black Pistons 9.8:1 for 472 W/76cc Heads 1968-1973 253, 282, 297
RB55172 10:1 Forged Pistons - 500 CID w/ 76cc Heads - D-Dish 252, 282, 297
RB55174 10:1 Forged Pistons - 500 CID w/ 120cc Heads - Domed 252, 282, 297
RB55176 9:1 Forged Pistons - 500 CID - Flat Top 252, 281, 296
RB55472 10:1 Forged Pistons - 472 CID w/ 76cc Heads - D-Dish 251, 281, 296
RB59110 Piston Ring Set for 472 / 500 251, 280
RB59115 Skinny (1/16") Moly Piston Ring Set for 472 / 500 for Cad Company Forged Pistons 251, 279
RB59170 Piston Ring Set for 425 250, 279
RB71100 Main Bearings for 472 / 500 / 425 / 368 250, 279
RB73101 Rod and Main Bearing Kit for 472 / 500 / 425 / 368 250, 278
RB75100 Rod Bearings for 472 / 500 / 425 / 368 249, 278
RB75110 Clevite 'H' Series Rod Bearings 249, 278
RB77101 Cam Bearings, Stock Replacement 249, 277
RB77102 Cam Bearings, CC3 Grooved / Dual Hole Style 248, 277

S

SM11111 HD Cadillac Motor Mounts '68-'73 RWD and '73 Eldo 354, 362
SM11112 HD Cadillac Motor Mounts '74-'76 353, 362
SM11115 Cadillac Motor Mounts '77-up RWD 353, 361
SM51150 '60-'64 500 Swap Motor Mount Kit 353, 361
SM51160 Universal Motor Mount Kit 352, 361
SM51170 G-Body Motor Mount Kit 352, 360
SM51180 Motor Mount Kit Weld-in 352, 360
SM91001 472 / 500 / 425 / 368 Into 63-67 Cadillac Swap Parts 351, 359
SM91002 472 / 500 / 425 / 368 Into X-frame 54-65 Cadillac Swap Parts 351, 359



T

TS11209 Exhaust Bolt Removal Tool Kit 117, 129, 134, 180, 189, 370
TS31004 Oil Filter Cutoff Tool 370
TS31101 Oil Primer Tool for '66 and up Cadillacs 228, 245, 370
TS71001 TDC Piston Stop 369
TS71002 Spark Plug Hole Air Hose 369
TS71004 Valve Spring Compressor 369
TS91001 Moroso Power/Speed Slide Rule Calculator 368
TS91011 Chilton Manual '67-'89 Cad. 368

V

VT10102 Timing Cover/Water Pump Bolt Kit Stainless Socket Head 180, 188
VT11011 472/500 Timing Cover 76, 420, 446
VT11021 472/500 Stainless Timing Cover 76, 420, 445
VT11022 425/368 Stainless Timing Cover 75, 419, 445, 463
VT13172 OE Spec Timing Set 419, 463
VT13173 Cloyes Street Roller Timing Set 419, 463
VT13174 True Roller Timing Chain Set 248, 418, 462
VT15111 Cam Gear Bolts ARP (shallow head) 179, 193
VT15151 Roller Cam Thrust Bearing 418, 442, 462
VT20120 120H Camshaft 418, 442
VT20205 205H Camshaft "The Cruiser" 417, 442
VT20250 250H Camshaft 417, 441
VT20275 275H Camshaft 417, 441
VT20300 300H Camshaft 416, 441
VT20350 SS 350 H Camshafts and Kits - High compression (10:1 or more) hot-rod street performance 416, 440
VT21120 CTA 120 H Camshaft - Low compression (9.2:1 or less) 415, 440
VT21121 CTA 120 H Cam KIT - Low compression (9.2:1 or less) 415, 439
VT21205 CTA 205 H Camshaft - Low compression (9.2:1 or less) 415, 439
VT21206 CTA 205 H Cam KIT - Low compression (9.2:1 or less) 414, 439
VT21250 CTA 250 H Camshaft - Low compression (9.2:1 or less) mild street performance 414, 438
VT21251 CTA 250 H Cam KIT - Low compression (9.2:1 or less) mild street performance 414, 438
VT21275 CTA 275 H Camshaft - Low compression (9.2:1 or less) mild street performance 413, 438
VT21276 CTA 275 H Cam KIT - Low compression (9.2:1 or less) mild street performance 413, 437
VT21300 CTA 300 H Camshaft - Low compression (9.2:1 or less) hot-rod street performance 413, 437
VT21301 CTA 300 H Cam KIT - Low compression (9.2:1 or less) hot-rod street performance 412, 437
VT22120 SS 120 H Camshaft High compression (10:1 or more) RV 412, 436
VT22121 SS 120 H Cam KIT - High Compression (10:1 or more) 411, 436
VT22205 SS 205 H Camshaft - High compression (10:1 or more) 411, 436
VT22206 SS 205 H Cam KIT - High compression (10:1 or more) 411, 435
VT22250 SS 250 H Camshaft - High compression (10:1 or more) mild street performance 410, 435
VT22251 SS 250 H Cam KIT - High compression (10:1 or more) mild street performance 410, 435
VT22275 SS 275 H Camshaft - High compression (10:1 or more) mild street performance 410, 434
VT22276 SS 275 H cam KIT - High compression (10:1 or more) mild street performance 409, 434
VT22300 SS 300 H High compression (10:1 or more) hot-rod street performance cam SS 300 H 409, 434
VT22301 SS 300 H Cam KIT - High compression (10:1 or more) hot-rod street performance 409, 433
VT23120 Pro/Cad 120 H Camshaft 408, 433
VT23121 Pro/Cad 120 H Cam Kit - Mild Hot Rod / Direct Drive Airboat 408, 433
VT23205 Pro/Cad 205 H Camshaft - Cruiser / budget hot rod 408, 432
VT23206 Pro/Cad 205 H Cam KIT - Cruiser / budget hot rod 407, 432
VT23540 Pro/Cad 540 H Camshaft - Budget Bracket Racing, Street Stompers; Oval Track @ 11:1 (Stock, Modified, IMCA) 407, 432
VT23541 Pro/Cad 540 H Cam KIT - Budget Bracket Racing, Street Stompers; Oval Track @ 11:1 (Stock, Modified, IMCA) 407, 431
VT23600 Pro/Cad 600 H Camshaft - Very strong hydraulic: PRO/Street; Bracket Racing; Asphalt Oval Track 406, 431
VT23601 Pro/Cad 600 H Cam KIT - Very strong hydraulic: PRO/Street; Bracket Racing; Asphalt Oval Track 406, 431
VT23625 Pro/Cad 625 H Camshaft - Very strong hydraulic: PRO/Street Stokers; Bracket Racing; Tractor Pulls 406, 430
vt23626 Pro/Cad 625 H Cam KIT - Very strong hydraulic: PRO/Street Stokers; Bracket Racing; Tractor Pulls 405, 430
VT23640 Pro/Cad 640 H Camshaft - Very strong hydraulic: PRO/Street Stokers; Bracket Racing; Tractor Pulls 405, 430
VT23641 Pro/Cad 640 H Cam KIT - Very strong hydraulic: PRO/Street Stokers; Bracket Racing; Tractor Pulls 405, 429
VT23650 Pro/Cad 650 H Camshaft - Radical Hydraulic: The baddest flat tappet hydraulic you can get



- 404, 429
- VT23651 Pro/Cad 650 H Cam KIT - Radical Hydraulic: The baddest flat tappet hydraulic you can get
404, 429
- VT25010 Solid Cams Custom Solid Kits from \$595 404, 428
- VT25650 Pro/Cad 650 S Our most popular SOLID flat tappet race cam 403, 428
- VT25651 Pro/Cad 650 S Our most popular SOLID flat tappet race cam KIT 403, 428
- VT26011 Roller Cams Custom Hydraulic Roller Kits from \$2288 403, 427
- VT26275 Mild street performance hydraulic roller cam R 275 H 402, 427
- VT26276R Mild street performance hydraulic roller cam KIT R 275 H 402, 426
- VT26350 R 350 H High compression (10:1 or more) hot-rod street performance hydraulic roller cam
401, 426
- VT26351 High compression (10:1 or more) hot-rod street performance hydraulic roller cam KIT R350h
401, 426
- VT26540 R 540 H Budget Bracket Racing, Street Stompers; Oval Track @ 11:1 (Stock, Modified, IMCA)
401, 425
- VT26541 R 540 H Budget Bracket Racing, Street Stompers; Oval Track @ 11:1 (Stock, Modified, IMCA)
KIT 400, 425
- VT26650 R 650 H Radical Hydraulic Roller: Roller version of the PC650H 400, 425
- VT26651 R 650 H Radical Hydraulic Roller: Roller version of the PC650H KIT 400, 424
- VT27011 Roller Cams Custom Solid Roller Kits from \$2195 399, 424
- VT31112 Lifters - Flat Tappet Hydraulic for 472, 500, 425, 368, and '67 429 399, 444
- VT33111 Valve Spring Kits Stage 1 398, 466
- VT33112 Valve Spring Kits Stage 2 398, 466
- VT33113 Valve Spring Kits Stage 3 398, 465
- VT33114 Valve Spring Kits Stage 4 397, 465
- VT37012 Viton Umbrella Valve Stem Seals 141, 170, 397, 467, 468
- VT51301 76cc Replacement Valves 397, 471
- VT51701 76cc 2.19 / 1.90 Stainless Valves 396, 470
- VT51702 76cc 2.25 / 1.90 Stainless Valves 396, 470
- VT53301 120cc (472 / 500) and 425 Replacement Valves 396, 470
- VT53701 120cc (472 / 500) and 425 2.11 / 1.77 Stainless Valves 395, 469
- VT53702 120cc (472 / 500) and 425 2.19 / 1.85 Stainless Valves 395, 469
- VT71101 OEM Rocker Components Full Set 395, 453, 458
- VT71310 Stage III (1.72:1) Shaft Rocker Assembly uses stock pushrods 394, 452, 456
- VT71420 Stage IV (1.73:1) Adjustable Roller Tip Shaft Rocker Assembly 394, 452, 456
- VT71440 Stage IV SS (1.73:1) Adjustable Roller Tip Shaft Rocker Assembly 394, 452, 455
- VT71710 Pro Street Roller Rockers 393, 451, 455
- VT71730 Pro Comp Roller Rockers 393, 451, 454
- VT71770 BoogieMan Pro Comp Roller Rockers 392, 450, 454
- VT73101 T-Pedestals - Aftermarket 392, 450, 458
- VT73102 Intake Rockers 1.65:1 392, 450, 458
- VT73103 Exhaust Rockers 1.65:1 391, 449, 457
- VT73104 Retaining Clips (mouse traps) 391, 449, 457
- VT75001 Adjustable pushrod 391, 449, 461
- VT75011 Custom Chromoly Pushrods 390, 448, 460
- VT75102 HD Stock Replacement Pushrod (single) 390, 448, 460
- VT75111 OE Replacement Pushrods (set of 16) 390, 448, 460
- VT75112 HD Stock Replacement Pushrod (Set of 16) 389, 447, 459
- VT75113 Over-Length OE Replacement Pushrods custom only 389, 447, 459
- VT90202 Valve Cover Stud and Nut Kit, Stainless 377, 383
- VT90203 Stud and Nut Kit Black Oxide 377, 382
- VT91021 Custom Valve Covers Powder Coating 117, 376, 385
- VT91101 Chrome Valve Covers 376, 386
- VT91111 Flat Top Valve Covers 376, 385
- VT91131 Flat Top Valve Covers with Raised Cadillac Script 375, 385
- VT91151 Flat Top Valve Covers with Raised Early Cadillac Script and Fins 375, 384
- VT91161 Fabricated Aluminum Valve Covers 375, 384
- VT93031 Valve Cover Grommet 374
- VT93032 OE Style 90 Degree PCV Grommet 374, 382
- VT93033 Grommet For Air Cleaner Housing 7, 374, 382
- VT93232 Baffled PCV Grommet 373, 381
- VT95111 Billet Aluminum Valve Cover Breather 373, 381
- VT95212 Chrome Valve Cover Breather w/ Hose Nipple 373, 381
- VT95331 Billet Aluminum Valve Cover Breather (w/ PCV valve) 372, 380
- VT95332 Chrome Valve Cover Breather (w/ PCV tube) 372, 380

W

- WS21101 Coolant Temperature Switch 75, 473
- WS51204 HEI Power / Tach Pigtales 196, 214, 472



505-823-9340
8333 JEFFERSON NE
ALBUQUERQUE, NM 87113
CADILLACPERFORMANCE.COM

WS66103 Alternator Wiring Conversion Kit 301, 320, 343, 472